



**25  
GTV**

**KATALOG  
PRODUKTÓW**

**PRODUCT CATALOGUE**

**КАТАЛОГ ПРОДУКЦИИ**

ÓŚWIETLENIE MEBLÓWE  
FURNITURE LIGHTING  
МЕБЕЛЬНОЕ ОСВЕЩЕНИЕ

SYSTEMY PRZESUWNE  
SLIDING DOOR SYSTEMS  
РАЗДВИЖНЫЕ СИСТЕМЫ

AKCESORIA DEKORACYJNE  
DECORATIVE ACCESSORIES  
ЛИЦЕВАЯ ФУРНИТУРА

AKCESORIA FUNKCYJNE  
FUNCTIONAL ACCESSORIES  
ФУНКЦИОНАЛЬНАЯ ФУРНИТУРА



**PL** GTV to międzynarodowy producent akcesoriów meblowych i oświetlenia. Jest jedną z najdynamiczniej rozwijających się firm w Polsce. Spółka obecna jest na kilkudziesięciu rynkach w Europie, Azji i Ameryce, a produkty z logo GTV znajdują się w milionach domów i biur na całym świecie. GTV jest firmą w 100% z polskim kapitałem. Spółka dysponuje własnym zapleczem techniczno-logistycznym umożliwiającym swobodne prowadzenie działalności o ogólnoświatowym zasięgu. Siedziba firmy to nowoczesne, w pełni zinforymatyzowane centrum logistyczne w Pruszkowie, w pobliżu autostrady A2. Na jego terenie znajdują się biurowiec oraz dwa magazyny o powierzchni 27 000 m kw. z wydzielonymi składami celnymi, mieszczące 35 000 europalet. Portfolio GTV to jedna z najbardziej kompletnych ofert na rynku. Obejmuje kilka tysięcy produktów, w kilkudziesięciu grupach produktowych, w tym m.in.: zawiasy, prowadnice, podnośniki, uchwyty, wyposażenie garderoby i kuchni oraz oświetlenie LED.

**EN** GTV is an international producer of furniture accessories and LED lighting. GTV has over 20 years of experience in cooperation with the largest furniture manufacturers in the world and millions of customers using the company's products. Today GTV is one of the international leaders in distribution of furniture accessories and LED lighting, present on dozens of markets worldwide. GTV's headquarter is a modern logistics center, located 25 km from the center of the Polish capital, Warsaw. GTV's head office is a four-story office building and two warehouses on an area of 27000 square meters with storage capacity of over 35,000 euro pallets. With its modern infrastructure, the company is able to fulfill orders from all over the world at the time indicated by the customer. GTV implementing its long-term business strategy, actively promotes its products by participating in the world's most prestigious trade fairs e.g. in Russia, Germany, Italy, Poland, Brazil. Professional service, competent team of specialists and transparent procedures allow us to effectively meet the needs of business partners.

**RU** GTV – это международный производитель мебелиной фурнитуры и освещения. Мы работаем в десятках стран Европы, Азии и Америки, а продукция с логотипом GTV известна во всем мире. GTV – это современный, полностью информатизированный логистический центр возле Варшавы. На его территории находится офисное здание и два склада площадью 27 000 м2 с отдельными таможенными складами вместимостью 35 000 европаллет. Дополнительно фирма располагает складскими помещениями площадью почти 5000 квадратных метров. Ассортимент компании GTV включает несколько тысяч наименований продукции: петли, направляющие, подъемники, ручки, оснащение для гардероба и кухни, светодиодное освещение.





**GTV**  
FURNITURE  
ACCESSORIES

- PL** GTV Furniture Accessories, marka obecna na rynku od ponad dwudziestu lat to niekwestionowany lider dostarczający najbardziej kompletne portfolio akcesoriów dla branży meblarskiej. Dzięki przemyślanej strategii rozwoju, marka oferuje nieosiągalną dla innych firm relację ceny do jakości, dostarczając funkcjonalne oraz zaprojektowane zgodnie z najnowszymi trendami produkty w przystępnych cenach.
- EN** GTV Furniture Accessories brand is present on the market for over 20 years, building its position as one of the international leaders. The company is present in Europe, Asia and America, whereas products with the GTV logo are to be found in millions of households and offices worldwide. Thanks to carefully planned strategy and logistics, GTV can offer products with an unreachable for other companies price to quality ratio.
- RU** Мебельная фурнитура с логотипом GTV известна на рынке уже более двадцати лет, а портфолио компании является одним из наиболее полных предложений на мебельном рынке. Благодаря продуманной стратегии развития, эффективному управлению и открытости к новым идеям, компания GTV быстро стала лидером в дистрибуции мебельной фурнитуры. Секрет успеха компании заключается в предоставлении продукции высокого качества по приемлемой цене.

- PL** GTV Sliding Door Systems, to marka która powstała w 2014 r. z myślą o profesjonalistach poszukujących rozwiązań ułatwiających i przyspieszających montaż drzwi przesuwnych. Systemy przesuwne zostały zaprojektowane przez naszych konstruktorów, dla których inspiracją były opinie polskich stolarzy. Dzięki tej owocnej współpracy powstał produkt, który nie tylko przekonuje praktycznymi, konstrukcyjnymi ulepszeniami. Są to również szczególnie decydujące o przewadze produktu jak unikatowy materiał, z którego wykonane zostały kółka w systemach jezdnych.
- EN** GTV Sliding Door Systems is a brand developed in 2014, for professionals seeking reliability and highest quality. Our systems have been created to meet the needs, of the most demanding customers. The idea behind the systems was inspired by carpenters, who tend to look for solutions, that will make their work more effective. GTV Sliding Door Systems offer not only practical constructional improvements. But also highest quality of components. The whole system is based on reliable elements, especially rollers thanks to which this system stands out of the competition. All of the functional accessories have been carefully selected and underwent thorough strict quality control.
- RU** Раздвижные системы GTV – бренд, созданный в 2014 году с мыслью о профессионалах, ищущих новые возможности, позволяющие ускорить процесс установки раздвижных дверей. Раздвижные системы GTV были запроектированы по инициативе производителей мебели и являются авторской разработкой инженеров компании GTV. В результате плодотворной работы был создан продукт, интересный не только своими техническими решениями, но и отличающийся качеством используемого материала в нижних ходовых элементах.

- PL** Marka GTV Lighting została wprowadzona na rynek 2007 r. oferując rozwiązania oświetleniowe przeznaczone do biur, budynków przemysłowych, magazynowych i użyteczności publicznej opartych na technologii LED. Portfolio zawiera również produkty LED dla klientów indywidualnych – źródła LED, oświetlenie meblowe. GTV Lighting to szeroka i kompletna oferta, elastyczność w podejściu do partnerów biznesowych a także serwis.
- EN** The GTV Lighting brand was launched in 2007, it has been created, to provide professional lighting solutions for offices, industrial buildings and warehouses - based on LED technology. The portfolio also includes LED solutions for private consumers – home and garden lighting, furniture lighting. GTV Lighting offers also a wide and complete portfolio of services, such as lighting planning consulting.
- RU** Товарная группа GTV освещение появилась в ассортименте компании в 2007 году и представляет собой подборку интересных световых решений для офисов, промышленных зданий, складских помещений, общественных зданий, а также решений подходящих индивидуальным клиентам – источники светодиодного освещения и освещение для мебели. GTV освещение предлагает широкий спектр продукции и гибкость в подходе к бизнес-партнёрам и услугам, которые мы предоставляем.

- PL** GTV Decor to marka oświetlenia dekoracyjnego, która została stworzona w zgodzie z najnowszymi trendami w światowym designie. Naszym celem jest dotarcie do Klientów o różnorodnych preferencjach i wspieranie ich w indywidualnych projektach mieszkaniowych. Dostarczamy oświetlenie dekoracyjne, które zapewni jakościowe korzystanie z przestrzeni. Śledzimy bieżące trendy we wzornictwie, w których indywidualny styl wnętrza odzwierciedla tożsamość Klienta. Bogactwo wzorów i modna, stonowana kolorystyka sprawiają, że w portfolio GTV DECOR każdy znajdzie coś dla siebie. Odcienie bieli, szarości, czerni, przemysłane detale oraz różnorodność lamp – to wszystko można odnaleźć w naszych pro-duktach, które liczą ponad 70 wzorów opraw.
- EN** GTV Decor is a brand of decorative lighting created in accordance with the latest trends in global design. Our aim is to reach out to customers with diverse preferences and support them in their individual home projects. We provide decorative lighting that ensures quality use of the space. We follow current trends in design, in which the individual style of the interior reflects the identity of the client. With the abundance of designs and fashionable, subdued colours, the GTV DECOR portfolio has a lot to offer to everyone. Shades of white, grey, black, well thought-out details and a variety of lamps - all this can be found in our products, including more than 70 luminaire designs.
- RU** GTV Decor — бренд декоративного освещения, созданный в соответствии с последними тенденциями мирового дизайна. Наша цель – найти клиентов с различными предпочтениями и поддержать их в реализации индивидуальных жилых проектов. Мы создаем декоративное освещение, которое обеспечит качественное использование пространства. Следим за современными тенденциями в дизайне, в которых стиль интерьера отражает индивидуальность заказчика. Богатство решений и модные цвета означают, что каждый найдет что-то для себя в ассортименте GTV DECOR. Оттенки белого, серого, черного, продуманные детали и разнообразие форм ламп – все это можно найти в нашей продукции, которая включает в себя более 70 дизайнов светильников.

## AKCESORIA FUNKCYJNE FUNCTIONAL ACCESSORIES ФУНКЦИОНАЛЬНАЯ ФУРНИТУРА

|   |                        |
|---|------------------------|
| Zawiasy<br>Hinges<br>Петли  | 64 – 101               |
| Amortyzatory<br>Buffers<br>Амортизаторы                                     | 102 – 107<br>118 – 121 |
| Podnośniki<br>Lifts<br>Подъёмники   | 108 – 117              |
| Prowadnice<br>Slides<br>Направляющие  | 122 – 159              |
| Systemy szuflad<br>Drawer systems<br>Выдвижные ящики                        | 160 – 199              |
| Elementy łączeniowe<br>Bridges and fittings<br>Соединительные элементы      | 203 – 232              |
| Listwy<br>Work top strip<br>Панки для столешниц                             | 233 – 235              |
| Mocowania do rur<br>Rails accessories and fittings<br>Крепление для труб    | 236 – 251              |
| Wyposażenie garderoby<br>Wardrobe accessories<br>Наполнение для шкафов-купе | 252 – 275              |
| Aksesoria kuchenne<br>Kitchen accessories<br>Кухонные аксессуары            | 200 – 202<br>276 – 297 |
| Aksesoria biurowe<br>Office accessories<br>Аксессуары для офиса             | 298 – 310              |
| Inne<br>Other<br>Другие   | 311 – 315              |

## AKCESORIA DEKORACYJNE DECORATIVE ACCESSORIES ЛИЦЕВАЯ ФУРНИТУРА

|                             |           |
|-----------------------------|-----------|
| Uchwyty<br>Handles<br>Ручки | 318 – 411 |
| Wieszaki<br>Hooks<br>Крючки | 412 – 429 |

|  |           |
|--|-----------|
| Wsporniki<br>Shelf supports<br>Полкодержатели        | 430 – 437 |
| Nóżki meblowe<br>Furniture legs<br>Мебельные ножки   | 438 – 458 |
| Nogi meblowe<br>Furniture legs<br>Мебельные опоры    | 459 – 475 |
| Rolki meblowe<br>Furniture castors<br>Колёсные опоры | 476 – 481 |

## **SYSTEMY PRZESUWNE SLIDING DOOR SYSTEMS РАЗДВИЖНЫЕ СИСТЕМЫ**

|  |           |
|--|-----------|
| Dolny układ jezdny<br>Bottom-running systems<br>Нижняя ходовая система | 486 – 516 |
| Górny układ jezdny<br>Top-running systems<br>Верхняя ходовая система   | 517 – 521 |

## **OŚWIETLENIE MEBLOWE FURNITURE LIGHTING МЕБЕЛЬНОЕ ОСВЕЩЕНИЕ**

|   |           |
|---|-----------|
| Taśmy LED<br>LED strips<br>Светодиодные ленты                       | 526 – 531 |
| Profile LED<br>LED profiles<br>Профили LED                          | 532 – 563 |
| Oprawy LED<br>LED fittings<br>Светодиодные светильники              | 563 – 573 |
| Akcesoria<br>Accessories<br>Аксессуары                              | 574 – 601 |
| Przedłużacze biurkowe<br>Desk power sockets<br>Выдвижные удлинители | 602 – 623 |

**AKCESORIA FUNKCYJNE**  
**FUNCTIONAL ACCESSORIES**  
**ФУНКЦИОНАЛЬНАЯ ФУРНИТУРА**



67

ZM-OT-STANDARD



67

ZM-DHC09-3DBE0



68

ZM-DHC08-3DBE0



68

ZM-DHC07-3DBE0



69

ZM-EHC09BE0



70

ZM-EHC08BE0



70

ZM-EHC07BE0



71

ZM-EHC09H04-BE



71

ZM-EHC08H04-BE



72

ZM-EHC07H04-BE



72

ZM-EHC09-3DBE0



73

ZM-EHC08-3DBE0





81

ZM-HCKT165-3DBE0-S



81

ZP-BIDI09-3DBE0



82

ZP-BIDI08-3DBE0



82

ZP-BIDI07-3DBE0



83

ZP-CONL09-BE



83

ZP-CONL08-BE



84

ZP-CONL07-BE



84

ZP-BICN090BE



85

ZP-BICN080BE



85

ZP-BICN070BE



86

ZP-KT30H2-BE



86

ZP-KT45H2-BE



87

ZP-KT90H2-BE



87

ZP-KTK90H6BE



88

ZP-KT165H2BE



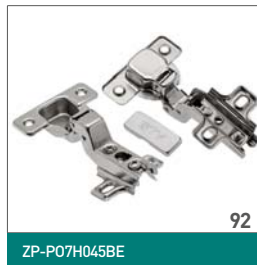

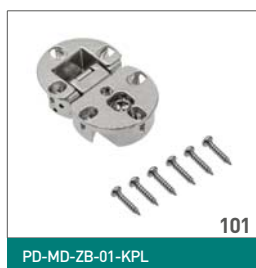
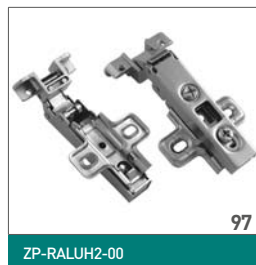

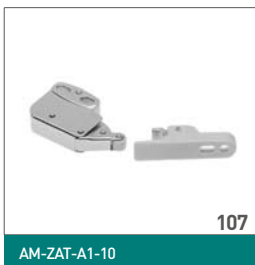

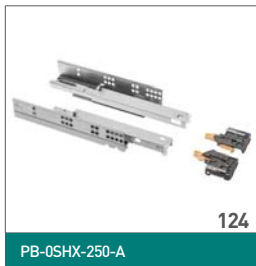







163

PB-AXISPRO-KPL69-450-60



165

PB-AXISPRO-WEWMOCA



166

PB-AXISPRO-WEWMOCB



166

PB-AXISPRO-WEWMOCC



167

PB-AXISPRO-WEWMOCD



167

PB-AXISPRO-ZESWEW-A AXISPRO



168

PB-AXISPRO-ZESWEW-B AXISPRO



168

PB-AXISPRO-ZESWEW-C AXISPRO



169

PB-AXISPRO-ZESWEW-D AXISPRO



169

PB-AXISPRO-RELKW300



169

PB-AXISPRO-ZNACZ-FRONT



171

PB-KW-KPL250A



171

PB-KW-KPL250B



172

PB-KW-KPL250C



172

PB-D-RELKW350

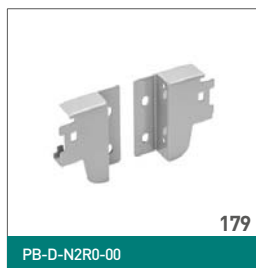
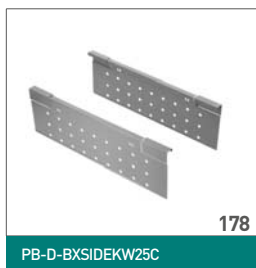



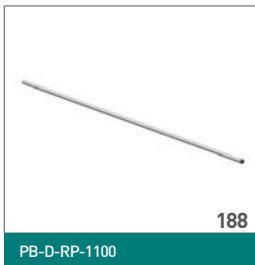

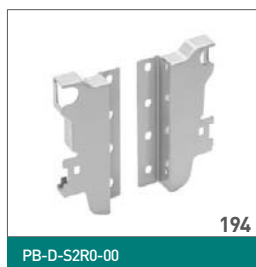
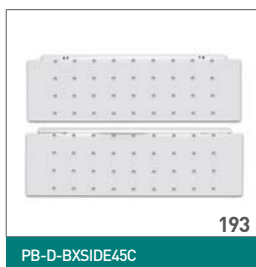
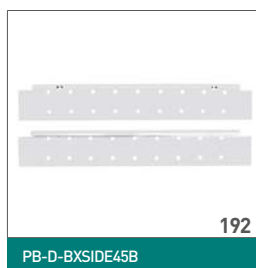

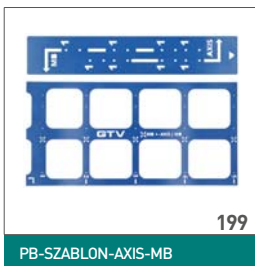
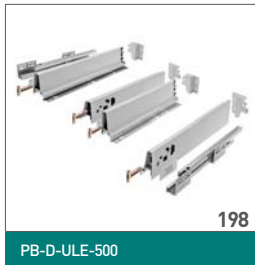
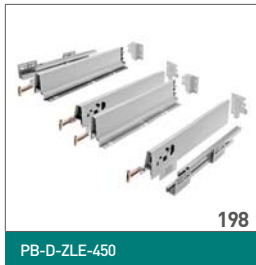



205

PP-00GS04-01



206

PP-GL-A48-01



206

PP-GL-B48-01



207

PP-GL-C6P-01



207

PP-GL-E410-01



208

PP-S0L003-01T



209

PP-S0L012-01T



209

PP-HS0006-01



210

PP-HS2710-01



210

MC-J63-01



211

MC-J65-08-01



211

MC-J123-01



212

MC-K135-06-01



212

MC-J01A-12-01



213

MC-J04A2-14-01







228

MM-FI20X6X7-PL10-A-1T



229

SZ-005-00-01T



229

WK-D0320-001



230

WK-CAM-15-12-D



230

WK-DOW63X45B-D



231

WK-CAM-15-DOW63X45-KPL-1T



231

WK-CF6450-01



232

MG-MENSA-010



232

PM-PFMH51-10

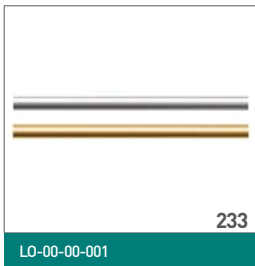

233

LO-00-00-001



233

LMB-BOCZ38L-05



234

LMB-KAT38-05



235

LMB-SZCZ38-05



235

RR-CH-OW-000



236

MR-RDRO-0000









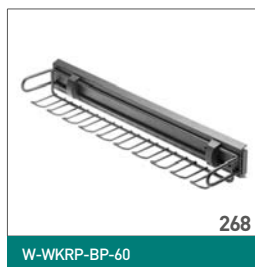



269

KO-SR100-30-10



270

WW-WSP00-01



270

WW-WSP000-01

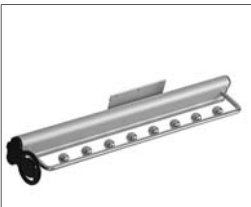

271

WW-WUBR00-1



271

WW-WSL250-01



272

WW-WSD250-01B



272

PP-P04570-20



273

WW-ZWBUT2-10



273

PG-GA4560-10



274

PG-AL4560-20



276

PB-45-400MF-2X16-60A



277

PB-45-0010X3-60A



278

PB-45-002X20-60A



279

PB-45-MF002X20-60A



280

PB-45-002X15-60A



281

PB-45-MF2X15-60A



282

PB-45-450-2X20-60A



283

PB-45-450MF20X10-60A



284

PB-45-MF342X17-60A



285

PB-45-600MF-2X27-60A

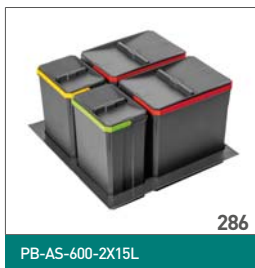

286

PB-AS-600-2X15L



287

PB-91024160V



287

PB-93004162601



288

KO-WMC450-60



289

KO-UMC450-60



290

KO-150B0-60



292

KO-300B0-60



293

KO-150B0-E-01



294

OC-A0150-06



294

OC-A0660-06



295

OC-2PV340-02-18



296

OC-A0450-06



296

OC-A0350K-06



297

OC-A0460D-06

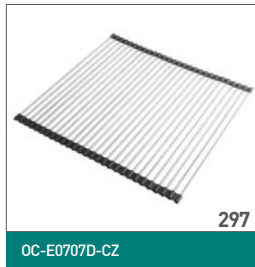

297

OC-E0707D-CZ

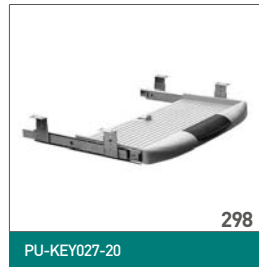

298

PU-KEY027-20



298

PU-KEYM27-20



299

PU-PK0-00-20



299

HB-USB-4X-60



300

LB-K80X80-05



300

LB-80X100-05



301

LB-80X160-05



301

LB-80X280-05



302

LB-80X500-05



302

PM-LBF160-01

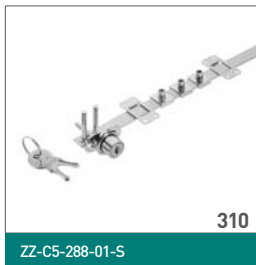



AKCESORIA DEKORACYJNE  
DECORATIVE ACCESSORIES  
ЛИЦЕВАЯ ФУРНИТУРА



318

UA-EXTEND-1200-20M



322

UZ-MONZA160-06



320

UZ-MONA-128-01-10



320

UA-ARS096-20



322

UZ-G2-160-01



322

UZ-TIVOL-192-01



323

UZ-BAGIO-128-01



324

UZ-ANCON-128-01



324

UZ-KATAN-320-01



325

UZ-40-032-01



325

UZ-55-025-05



326

UZ-60-032-01



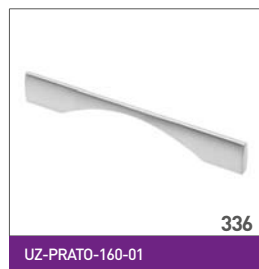





346

UZ-G1-128-01



347

UZ-NORD-128-03



348

UZ-VENICE-128-90



349

UZ-FABRICO-128-18



350

UZ-OTTO-128-06



351

UZ-EVER-128-90



352

GZ-POINT-1-06



353

GZ-LORENA-1-18



353

UZ-STEP-160-07



354

UZ-FLOW-128-06



355

UZ-STILO-128-18



356

UA-STRUCTURE-128-20M



357

UZ-01-096-01



357

UZ-05-096-01



358

UZ-06-128-01









392

UZ-AREZO-96-04



393

UZ-ABIAT-128-04



393

UZ-ADRIN-96-04



394

UZ-ACERA-96-04



394

UZ-OLBIA-96-04



395

UZ-MARSA-64-07



396

UZ-ROYAL1-96-10-03



397

UZ-WP1146-04



397

GZ-WP1136-04



398

GZ-WP1148-04



398

GZ-WP1152-04



399

UZ-REN096-04A



399

KT-WP1147-04



400

GZ-CENTO-1-04



401

GZ-SONET-1-07





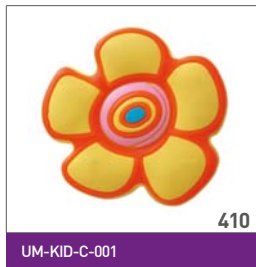
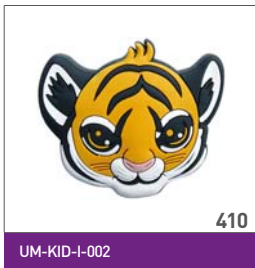

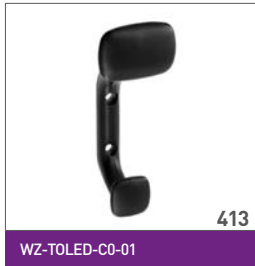

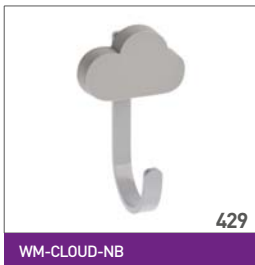

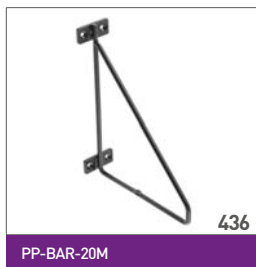
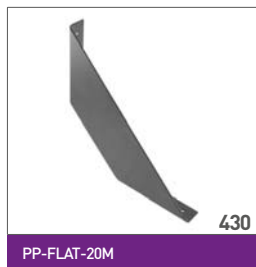





448

NM-STOMP-100-01



448

NM-MDN-D4-01



449

NM-MDN926-01



449

NM-MDN927-01



450

NM-MDN941-01



450

NM-WPJ22-D20



451

BP-SLZIGW-10



451

BP-SLZIGW-21



452

NM-STOPKA-M6



452

NM-STOPKSZESTK-M6



453

NM-MUFAWB-00



453

NM-DPD20-100



454

NM-KL-DPL-20



454

NM-DPA20-100



455

NM-KL-DPA-20

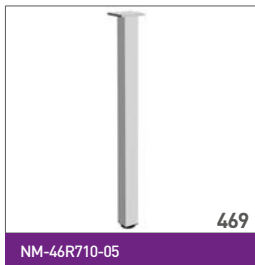







**SYSTEMY PRZESUWNE  
SLIDING DOOR SYSTEMS  
РАЗДВИЖНЫЕ СИСТЕМЫ**

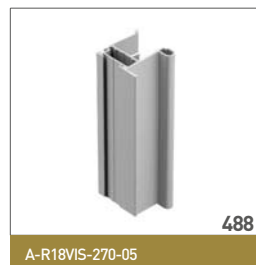

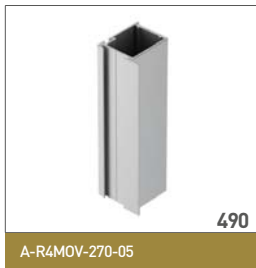
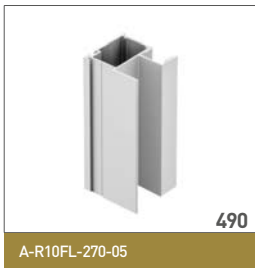

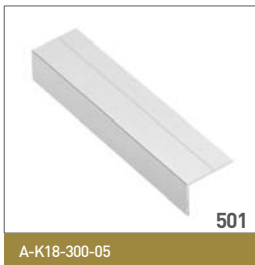
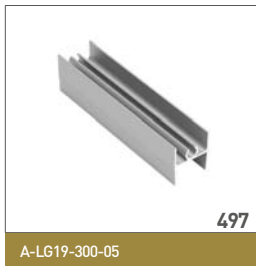

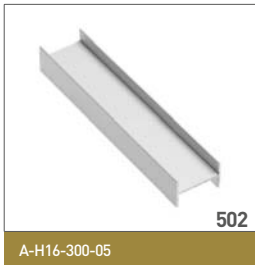

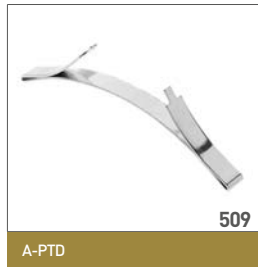



513

A-USZCZ-CHM4



513

A-USZCZ-TDEV02



513

A-B63-40



514

A-B63-32



514

A-SOFT-30



514

A-MSOFT-RAMA



514

A-SOFT-30Z



515

A-MSOFT-ADAPT



515

ZZ-SP-105-05



515

A-PW-RC-D0C



516

A-TMITO-200-00



516

A-MITO-PLUS



517

A-SN-FSET



518

A-SN-HSET1



519

A-SN-SDP-TU



520

A-BUDP-SET



521

A-SN-LOFT-200-20MN

## OŚWIETLENIE MEBLOWE FURNITURE LIGHTING МЕБЕЛЬНОЕ ОСВЕЩЕНИЕ



526

LD-3528-300-20-ZB



528

LD-3528-300-20-ZB-50



528

LD-2835-24V-300-20-ZB



529

LD-ZL5RGB150-00



530

LD-C0B12V-20-ZB



531

LD-NF-12V6x12-65-ZB



532

PA-GLAXGKL3M-00C



534

PA-GLAXGKS3M-00C



536

PA-GLAXGKW3M-00C











574

LD-ZAS75W-30



574

LD-ZAS24PR080W-30



575

LD-ZZAS07PROKD6



576

LD-ZASPR007W-30



576

LD-ZAS150-NW



577

LD-ZAS350-NW



577

LD-WZA20W-NW



578

LD-ZASPU15W-30N



578

LD-ZSKL15-00N



579

LD-ZWND6W-10



579

LD-ZAC6WDE-RGB



580

LD-KONMINI-RGB



581

LD-KONML-MONO



581

LD-KONML-MONO-PIL



582

LD-KONML-MONO-PAN



582

LD-KONML-RGBW



583

LD-KONML-RGBW-PIL



583

LD-KONML-WRGB-PAN



584

LD-KONML-WIFI



584

LD-KONML-AD



586

AE-WDBP1-10N



586

AE-WDBP2CCT-10N



588

AE-WBEZDC-10S



588

AE-WBEZDK15-10



589

AE-WBEZDPIR-10



589

AE-WBEZDPIR2-20



590

AE-WBBUNI-10DIM



590

AE-WDSB-10DIM



591

AE-WBEZD-NB



591

AE-WPDRW-00



592

AE-WLPR-60



592

AE-WLB01-10



593

AE-WLIP44-15



593

LD-DIMLED-10



594

AE-WLLAN1-10



594

AE-WLSZN1-10



595

LD-KABE2M-00



595

LZ-KA2MM-10



596

LZ-KAPR2M-10



596

LZ-AKZ312-10N



597

LZ-AKZ612-10N



597

LD-ZTL8MM-02N



598

LD-ZTKT8MM-02N



598

LD-ZTK8MM-02N



599

LD-ZTL82M-2N





**AKCESORIA FUNKCYJNE  
FUNCTIONAL ACCESSORIES  
ФУНКЦИОНАЛЬНАЯ ФУРНИТУРА**

|   |                        |
|---|------------------------|
| Zawiasy<br>Hinges<br>Петли  | 64 – 101               |
| Amortyzatory<br>Buffers<br>Амортизаторы                                     | 102 – 107<br>118 – 121 |
| Podnośniki<br>Lifts<br>Подъёмники   | 108 – 117              |
| Prowadnice<br>Slides<br>Направляющие  | 122 – 159              |
| Systemy szuflad<br>Drawer systems<br>Выдвижные ящики                        | 160 – 199              |
| Elementy łączeniowe<br>Brackets and fittings<br>Соединительные элементы     | 203 – 232              |
| Listwy<br>Work top strip<br>Панки для столешниц                             | 233 – 235              |
| Mocowania do rur<br>Rails accessories and fittings<br>Крепление для труб    | 236 – 251              |
| Wyposażenie garderoby<br>Wardrobe accessories<br>Наполнение для шкафов-купе | 252 – 275              |
| Akcesoria kuchenne<br>Kitchen accessories<br>Кухонные аксессуары            | 200 – 202<br>276 – 297 |
| Akcesoria biurowe<br>Office accessories<br>Аксессуары для офиса             | 298 – 310              |
| Inne<br>Other<br>Другие   | 311 – 315              |







**MB**  
MODERN BOX

**Orientacyjna ilość zawiasów puszkowych Ø35\***

\* Nie dotyczy modeli specjalnych o szerokim kącie otwarcia

**Approximate amount of hinges Ø35\***

\* Not applicable for special hinges with wide opening angle

**Предполагаемое количество петель 35\*Ø**

\* Не касается специальных моделей с широким углом открывания

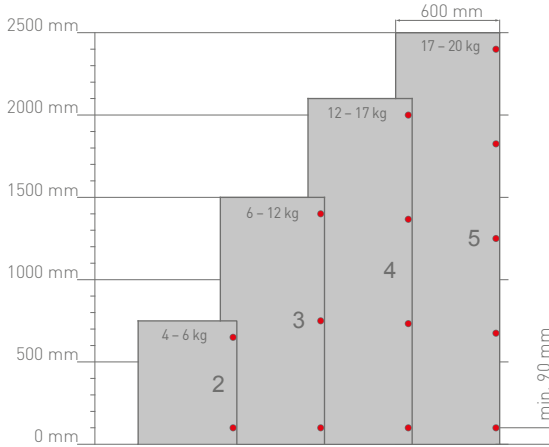

**Orientacyjna ilość zawiasów puszkowych Ø26 oraz Ø35\***

\* Dotyczy modeli specjalnych o szerokim kącie otwarcia

**Approximate amount of hinges Ø26 and Ø35\***

\* Applicable for special hinges with wide opening angle

**Предполагаемое количество петель Ø26 и Ø35\***

\* Касается специальных моделей с широким углом открывания

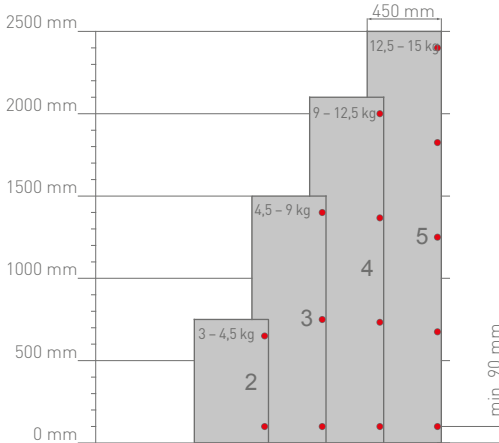

- Ilość użytych zawiasów jest zależna od wysokości, szerokości i ciężaru frontu.
- W celu zapewnienia stabilności odległość między zawiasami powinna być jak największa.
- Przed przystąpieniem do seryjnej produkcji należy przeprowadzić próbę montażu i sprawdzić poprawność funkcjonowania.
- Number of hinges that should be used, depends on the height, width and weight of the front.
- To ensure stability, the distance between the hinges should be as big as possible.
- Before starting mass production, mounting tests should be performed in order to ensure proper functioning.
- Количество использованных петель зависит от высоты, ширины и веса фасада.
- Для обеспечения стабильности, расстояние между петлями должно быть как можно больше.
- Перед началом серийного производства необходимо провести пробу монтажа и проверить исправность функциональности петель.

Mechanizm SoftMove  
SoftMove mechanism  
Механизм SoftMove

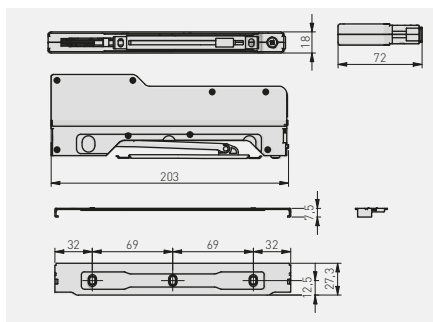

|                |                   |
|----------------|-------------------|
| ZM-OT-STANDARD | stal, tworzywo    |
| ZN-OT-HEAVY*   | steel, plastic    |
|                | сталь, пластмасса |



\*Produkt dostępny na indywidualne zamówienie / Available for special orders / Товар доступен под заказ

Zawias hydrauliczny SOLID PLUS, nakładany  
Hydraulic cup hinge SOLID PLUS, overlay door  
Гидравлическая петля SOLID PLUS, накладная

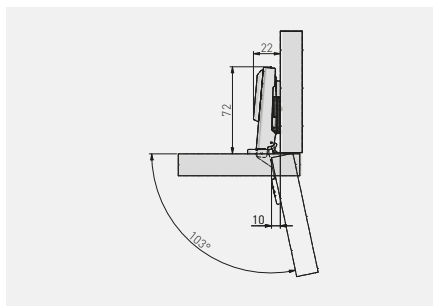

|                 |       |   |     |        |       |
|-----------------|-------|---|-----|--------|-------|
| ZM-DCHC09-3DBEO | H = 0 | — | —   | nikiel | stal  |
| ZM-DCHC09-3DZEO |       | — | x 2 | nickel | сталь |







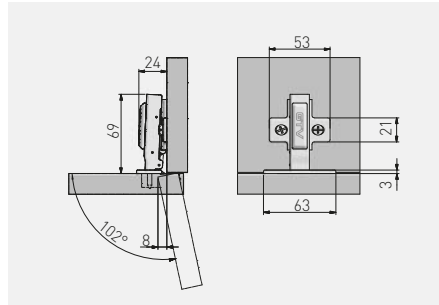

\*Produkt dostępny na indywidualne zamówienie / Available for special orders / Товар доступен под заказ



Zawias hydrauliczny ECHC, nakładany  
 Hydraulic cup hinge ECHC, overlay door  
 Гидравлическая петля ECHC, накладная



|   |   |   |   |   |   |
|---|---|---|---|---|---|
|  |  |  |  |  |  |
| ZM-ECHC09BEO  | H = 0   | x 4   | —   | nikiel<br>nickel  | stal<br>steel   |
| ZM-ECHC09ZEO  |   | x 2   | x 2   | никель  | сталь   |



\*Produkt dostępny na indywidualne zamówienie / Available for special orders / Товар доступен под заказ



Zawias hydrauliczny ECHC, bliźniaczy  
 Hydraulic cup hinge ECHC, twin overlay door  
 Гидравлическая петля ECHC, полунакладная

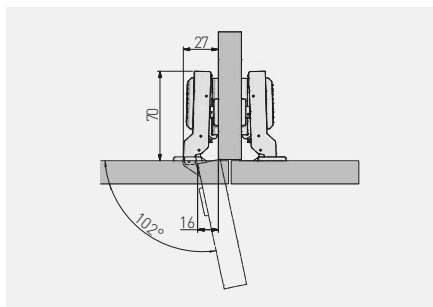

|              |       |     |     |                  |               |
|--------------|-------|-----|-----|------------------|---------------|
|              |       |     |     |                  |               |
| ZM-ECHC08BEO | H = 0 | x 4 | —   | nikiel<br>nickel | stal<br>steel |
| ZM-ECHC08ZEO |       | x 2 | x 2 | nikiel<br>nickel | stal<br>steel |



\*Produkt dostępny na indywidualne zamówienie / Available for special orders / Товар доступен под заказ

Zawias hydrauliczny ECHC, wpuszczany  
 Hydraulic cup hinge ECHC, inset door  
 Гидравлическая петля ECHC, внутренняя

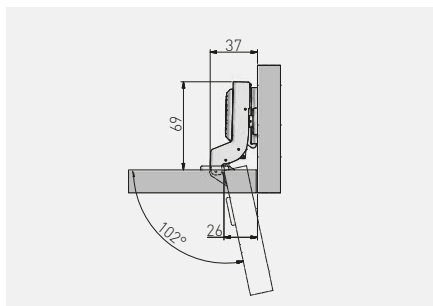

|              |       |     |     |                  |               |
|--------------|-------|-----|-----|------------------|---------------|
|              |       |     |     |                  |               |
| ZM-ECHC07BEO | H = 0 | x 4 | —   | nikiel<br>nickel | stal<br>steel |
| ZM-ECHC07ZEO |       | x 2 | x 2 | nikiel<br>nickel | stal<br>steel |



\*Produkt dostępny na indywidualne zamówienie / Available for special orders / Товар доступен под заказ

Zawias hydrauliczny ECHC, nakładany  
 Hydraulic cup hinge ECHC, overlay door  
 Гидравлическая петля ECHC, накладная

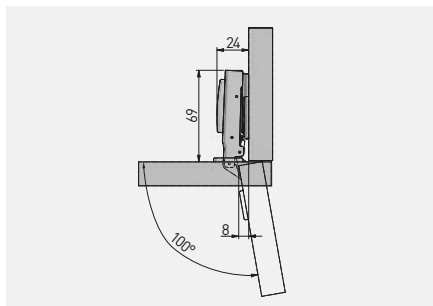

|                 |       |     |   |                            |                        |
|-----------------|-------|-----|---|----------------------------|------------------------|
|                 |       |     |   |                            |                        |
| ZM-ECHC09H04-BE | H = 0 | x 6 | — | nikiel<br>nickel<br>нικель | stal<br>steel<br>сталь |



\*Produkt dostępny na indywidualne zamówienie / Available for special orders / Товар доступен под заказ

Zawias hydrauliczny ECHC, bliźniaczy  
 Hydraulic cup hinge ECHC, twin overlay door  
 Гидравлическая петля ECHC, полунакладная

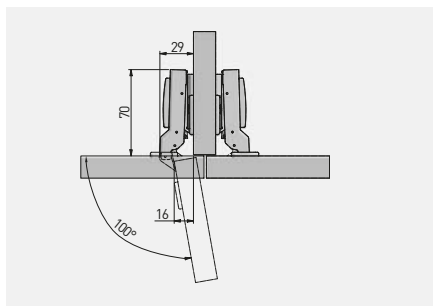

|                 |       |     |   |                            |                        |
|-----------------|-------|-----|---|----------------------------|------------------------|
|                 |       |     |   |                            |                        |
| ZM-ECHC08H04-BE | H = 0 | x 6 | — | nikiel<br>nickel<br>нικель | stal<br>steel<br>сталь |



\*Produkt dostępny na indywidualne zamówienie / Available for special orders / Товар доступен под заказ

Zawias hydrauliczny ECHC, wpuszczany  
 Hydraulic cup hinge ECHC, inset door  
 Гидравлическая петля ECHC, внутренняя

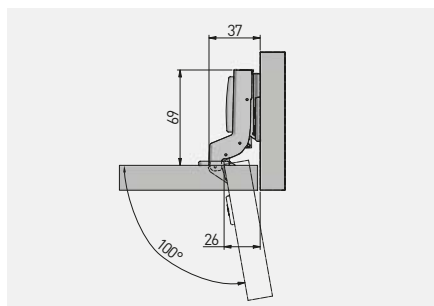

|                 |       |     |   |                            |                        |
|-----------------|-------|-----|---|----------------------------|------------------------|
|                 |       |     |   |                            |                        |
| ZM-ECHC07H04-BE | H = 0 | x 6 | — | nikiel<br>nickel<br>ннкель | stal<br>steel<br>сталь |



\*Produkt dostępny na indywidualne zamówienie / Available for special orders / Товар доступен под заказ

Zawias hydrauliczny ECHC3D prosty, z regulacją mimośrodową  
 Hydraulic cup hinge ECHC3D with eccentric adjustment, straight  
 Гидравлическая петля с эксцентриком ECHC3D, накладная

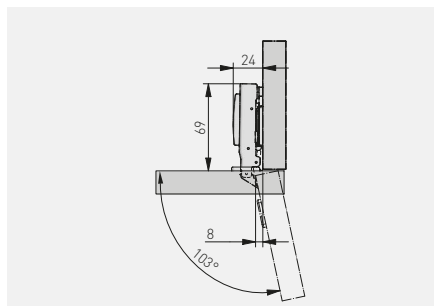

|                 |       |     |   |                            |                        |
|-----------------|-------|-----|---|----------------------------|------------------------|
|                 |       |     |   |                            |                        |
| ZM-ECHC09-3DBE0 | H = 0 | x 4 | — | nikiel<br>nickel<br>ннкель | stal<br>steel<br>сталь |



\*Produkt dostępny na indywidualne zamówienie / Available for special orders / Товар доступен под заказ



Zawias hydrauliczny ECHC3D półwpuszczany z regulacją mimośrodową  
 Hydraulic cup hinge ECHC with eccentric adjustment, half-overlay door  
 Гидравлическая петля с эксцентриком ECHC3D, полунакладная

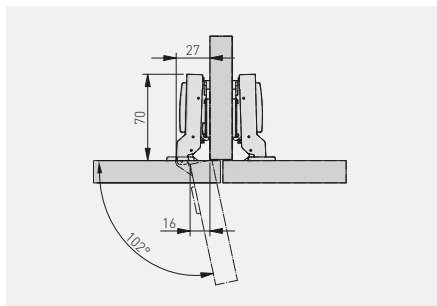

|                 |       |     |   |                            |                        |
|-----------------|-------|-----|---|----------------------------|------------------------|
|                 |       |     |   |                            |                        |
| ZM-ECHC08-3DBEO | H = 0 | x 4 | — | nikiel<br>nickel<br>нικель | stal<br>steel<br>сталь |



\*Produkt dostępny na indywidualne zamówienie / Available for special orders / Товар доступен под заказ

Zawias hydrauliczny ECHC3D wpuszczany, z regulacją mimośrodową  
 Hydraulic cup hinge ECHC with eccentric adjustment, inset door  
 Гидравлическая петля с эксцентриком ECHC3D, внутренняя

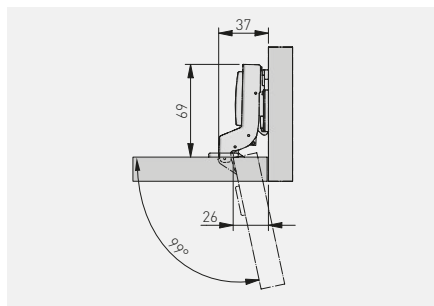

|                 |       |     |   |                            |                        |
|-----------------|-------|-----|---|----------------------------|------------------------|
|                 |       |     |   |                            |                        |
| ZM-ECHC07-3DBEO | H = 0 | x 4 | — | nikiel<br>nickel<br>нικель | stal<br>steel<br>сталь |



\*Produkt dostępny na indywidualne zamówienie / Available for special orders / Товар доступен под заказ

Zawias hydrauliczny CNHC z regulacją mimośrodową, nakładany  
 Hydraulic cup hinge CNHC with eccentric adjustment, overlay door  
 Гидравлическая петля CNHC с эксцентриком, накладная

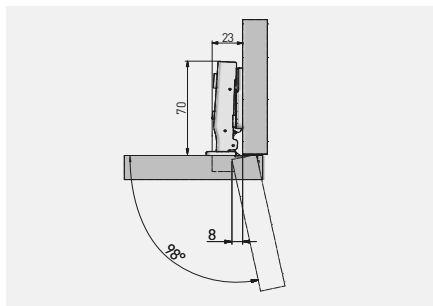

|              |       |   |   |                            |                        |
|--------------|-------|---|---|----------------------------|------------------------|
|              |       |   |   |                            |                        |
| ZM-CNHC09BR2 | H = 0 | - | - | nikiel<br>nickel<br>НИКЕЛЬ | stal<br>steel<br>СТАЛЬ |



Zawias hydrauliczny CNHC z regulacją mimośrodową, bliźniaczy  
 Hydraulic cup hinge CNHC with eccentric adjustment, twin overlay door  
 Гидравлическая петля CNHC с эксцентриком, полунакладная

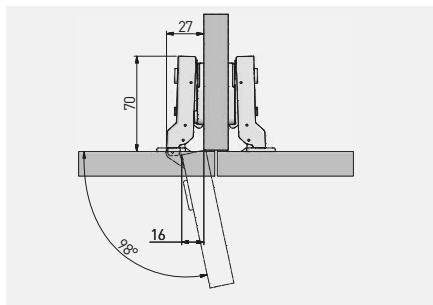

|              |       |   |   |                            |                        |
|--------------|-------|---|---|----------------------------|------------------------|
|              |       |   |   |                            |                        |
| ZM-CNHC08BR2 | H = 0 | - | - | nikiel<br>nickel<br>НИКЕЛЬ | stal<br>steel<br>СТАЛЬ |



Zawias hydrauliczny CNHC z regulacją mimośrodową, wpuszczany  
 Hydraulic cup hinge CNHC with eccentric adjustment, inset door  
 Гидравлическая петля CNHC с эксцентриком, внутренняя

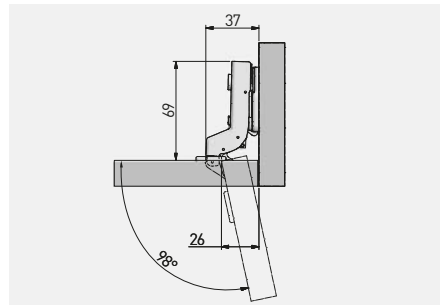

|              |       |   |   |                            |                        |
|--------------|-------|---|---|----------------------------|------------------------|
|              |       |   |   |                            |                        |
| ZM-CNHC07BR2 | H = 0 | - | - | nikiel<br>nickel<br>нικель | stal<br>steel<br>сталь |



Zawias hydrauliczny INHC, nakładany  
 Hydraulic cup hinge INHC, overlay door  
 Гидравлическая петля INHC, накладная

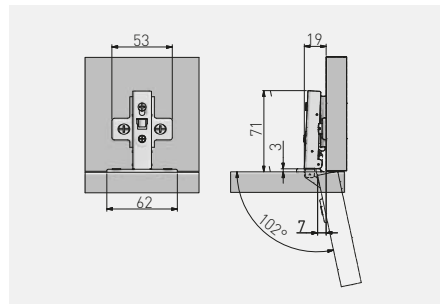

|               |       |   |     |                            |                        |
|---------------|-------|---|-----|----------------------------|------------------------|
|               |       |   |     |                            |                        |
| ZM-INHC090BEO | H = 0 | - | -   | nikiel<br>nickel<br>нικель | stal<br>steel<br>сталь |
| ZM-INHC090ZEO |       | - | x 2 |                            |                        |



\*Produkt dostępny na indywidualne zamówienie / Available for special orders / Товар доступен под заказ

Zawias hydrauliczny INHC, bliźniaczy  
Hydraulic cup hinge INHC, twin overlay door  
Гидравлическая петля INHC, полунакладная

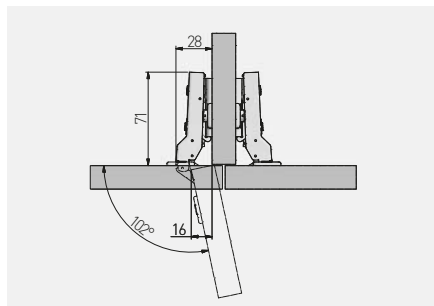

|               |       |   |     |                  |               |
|---------------|-------|---|-----|------------------|---------------|
|               |       |   |     |                  |               |
| ZM-INHC080BEO | H = 0 | — | —   | nikiel<br>nickel | stal<br>steel |
| ZM-INHC080ZEO |       | — | x 2 | никель           | сталь         |



\*Produkt dostępny na indywidualne zamówienie / Available for special orders / Товар доступен под заказ

Zawias hydrauliczny INHC, wpuszczany  
Hydraulic cup hinge INHC, inset door  
Гидравлическая петля INHC, внутренняя

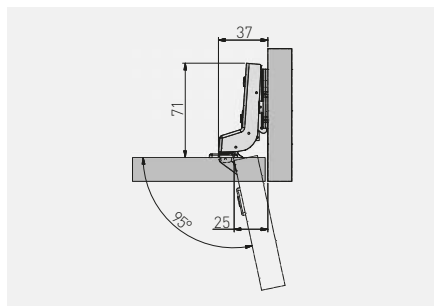

|               |       |   |     |                  |               |
|---------------|-------|---|-----|------------------|---------------|
|               |       |   |     |                  |               |
| ZM-INHC070BEO | H = 0 | — | —   | nikiel<br>nickel | stal<br>steel |
| ZM-INHC070ZEO |       | — | x 2 | никель           | сталь         |



\*Produkt dostępny na indywidualne zamówienie / Available for special orders / Товар доступен под заказ

Zawias kątowy 30°, hydrauliczny HCKT  
 Hydraulic corner cup hinge 30° HCKT  
 Угловая петля 30°, гидравлическая HCKT

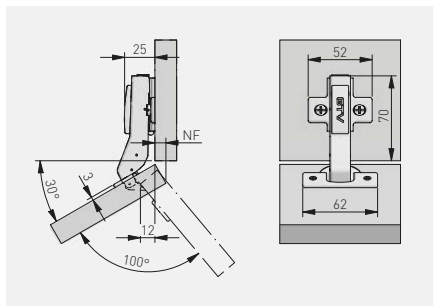

|                |       |     |     |                  |               |
|----------------|-------|-----|-----|------------------|---------------|
|                |       |     |     |                  |               |
| ZM-HCKT30-BE-S | H = 0 | x 4 | —   | nikiel<br>nickel | stal<br>steel |
| ZM-HCKT30-ZE-S |       | x 2 | x 2 | nikiel<br>nickel | stal<br>steel |



\*Produkt dostępny na indywidualne zamówienie / Available for special orders / Товар доступен под заказ

Zawias kątowy 45° hydrauliczny HCKT  
 Hydraulic corner cup hinge 45° HCKT  
 Угловая петля 45°, гидравлическая HCKT

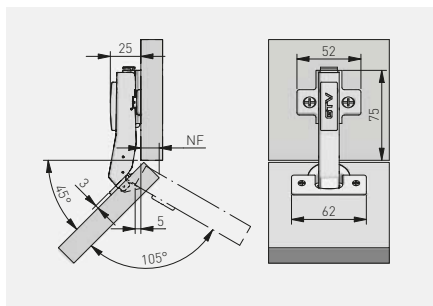

|                |       |     |     |                  |               |
|----------------|-------|-----|-----|------------------|---------------|
|                |       |     |     |                  |               |
| ZM-HCKT45-BE-S | H = 0 | x 4 | —   | nikiel<br>nickel | stal<br>steel |
| ZM-HCKT45-ZE-S |       | x 2 | x 2 | nikiel<br>nickel | stal<br>steel |



\*Produkt dostępny na indywidualne zamówienie / Available for special orders / Товар доступен под заказ

Zawias kątowy 45° HCKT z regulacją mimośrodową  
 Corner hinge 45° HCKT with eccentric adjustment  
 Угловая петля 45° HCKT с эксцентриком

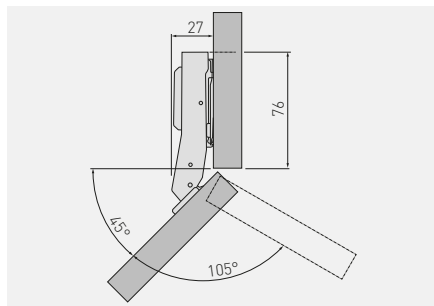

|                   |       |     |   |                            |                        |
|-------------------|-------|-----|---|----------------------------|------------------------|
|                   |       |     |   |                            |                        |
| ZM-HCKT45-3DBE0-S | H = 0 | x 4 | — | nikiel<br>nickel<br>нικель | stal<br>steel<br>сталь |



\*Produkt dostępny na indywidualne zamówienie / Available for special orders / Товар доступен под заказ

Zawias równoległy hydrauliczny HCKT  
 Parallel hydraulic hinge HCKT  
 Гидравлическая петля под фальшпанель HCKT

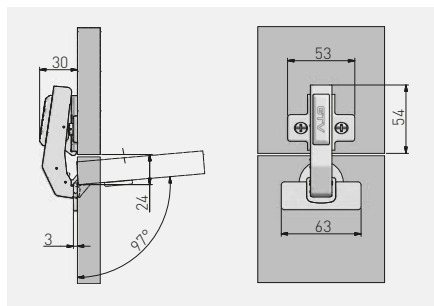

|                |       |     |     |                            |                        |
|----------------|-------|-----|-----|----------------------------|------------------------|
|                |       |     |     |                            |                        |
| ZM-HCKT90-BE-S | H = 0 | x 4 | —   | nikiel<br>nickel<br>нικель | stal<br>steel<br>сталь |
| ZM-HCKT90-ZE-S |       | x 2 | x 2 |                            |                        |



\*Produkt dostępny na indywidualne zamówienie / Available for special orders / Товар доступен под заказ

Zawias równoległy HCKT z regulacją mimośrodową  
 Parallel hinge HCKT with eccentric adjustment  
 Петля под фальшпанель HCKT с эксцентриком

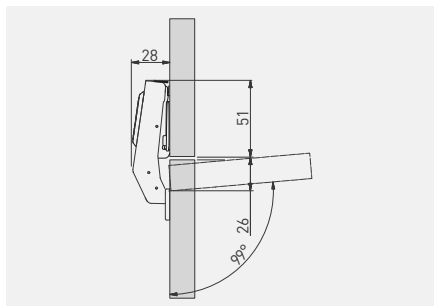

|                   |       |     |   |                            |                        |
|-------------------|-------|-----|---|----------------------------|------------------------|
|                   |       |     |   |                            |                        |
| ZM-HCKT90-3DBEO-S | H = 0 | x 4 | — | nikiel<br>nickel<br>никель | stal<br>steel<br>сталь |



\*Produkt dostępny na indywidualne zamówienie / Available for special orders / Товар доступен под заказ

Zawias równoległy – krótkie ramię ze sprężyną dociągającą KT  
 Parallel hinge – short arm KT  
 Петля под фальшпанель с пружиной, с коротким плечем KT

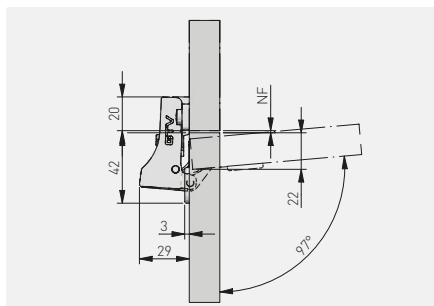

|               |       |     |   |                            |                        |
|---------------|-------|-----|---|----------------------------|------------------------|
|               |       |     |   |                            |                        |
| ZM-HCKTK90-ZE | H = 0 | x 2 | — | nikiel<br>nickel<br>никель | stal<br>steel<br>сталь |



Zawias z ujemnym uskokiem 155° hydrauliczny HCKT  
 Hydraulic set-off hinge 155° HCKT  
 Гидравлическая петля 155° HCKT

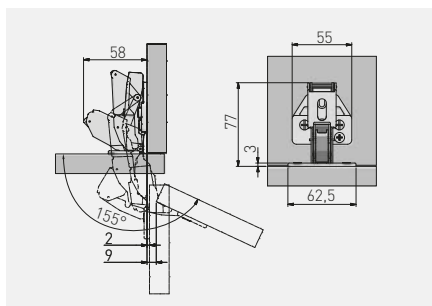

|              |       |   |     |                  |                            |
|--------------|-------|---|-----|------------------|----------------------------|
|              |       |   |     |                  |                            |
| ZM-HCKT155BE | H = 0 | — | —   | nikiel<br>nickel | stal, ZnAl<br>steel, ZnAl  |
| ZM-HCKT155ZE |       | — | x 2 | никель<br>nickel | сталь, ZnAl<br>steel, ZnAl |



\*Produkt dostępny na indywidualne zamówienie / Available for special orders / Товар доступен под заказ

Zawias 165° hydrauliczny HCKT  
 Hydraulic hinge 165° HCKT  
 Гидравлическая петля 165° HCKT

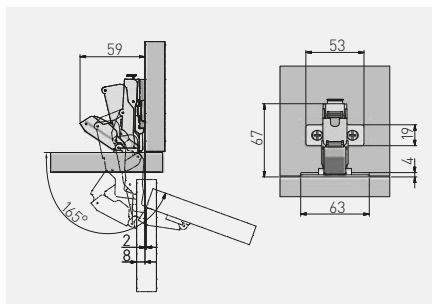

|                |       |   |     |                  |                |
|----------------|-------|---|-----|------------------|----------------|
|                |       |   |     |                  |                |
| ZM-HCKT165BE-S | H = 0 | — | —   | nikiel<br>nickel | stal<br>steel  |
| ZM-HCKT165ZE-S |       | — | x 2 | никель<br>nickel | сталь<br>steel |



\*Produkt dostępny na indywidualne zamówienie / Available for special orders / Товар доступен под заказ



Zawias 165° hydrauliczny HCKT z regulacją mimośrodową  
 Hydraulic hinge 165° HCKT with eccentric adjustment  
 Гидравлическая петля 165° HCKT с эксцентриком

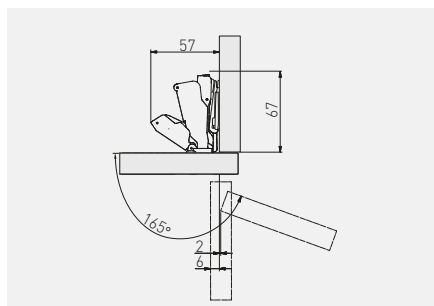

|                    |       |   |   |                            |                        |
|--------------------|-------|---|---|----------------------------|------------------------|
|                    |       |   |   |                            |                        |
| ZM-HCKT165-3DBEO-S | H = 0 | — | — | nikiel<br>nickel<br>никель | stal<br>steel<br>сталь |



\*Produkt dostępny na indywidualne zamówienie / Available for special orders / Товар доступен под заказ

Zawias SOLID, nakładany  
 Hinge SOLID, overlay door  
 Петля SOLID, накладная

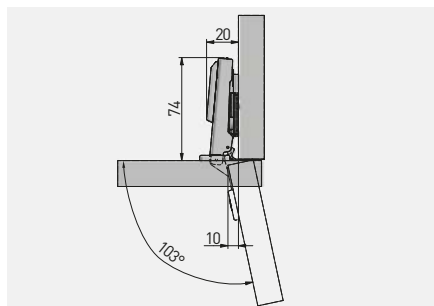

|                 |       |   |   |                            |                        |
|-----------------|-------|---|---|----------------------------|------------------------|
|                 |       |   |   |                            |                        |
| ZP-BIDI09-3DBEO | H = 0 | — | — | nikiel<br>nickel<br>никель | stal<br>steel<br>сталь |



\*Produkt dostępny na indywidualne zamówienie / Available for special orders / Товар доступен под заказ

Zawias SOLID, bliźniaczy  
Hinge SOLID, twin overlay door  
Петля SOLID, полунакладная

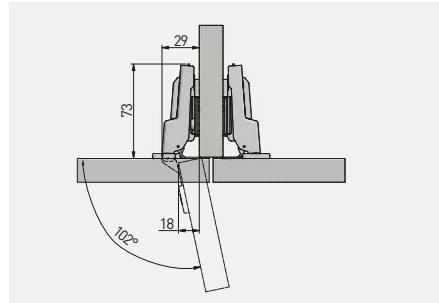

|                 |       |   |   |                            |                        |
|-----------------|-------|---|---|----------------------------|------------------------|
|                 |       |   |   |                            |                        |
| ZP-BIDI08-3DBEO | H = 0 | — | — | nikiel<br>nickel<br>никель | stal<br>steel<br>сталь |



\*Produkt dostępny na indywidualne zamówienie / Available for special orders / Товар доступен под заказ

Zawias SOLID, wpuszczany  
Hinge SOLID, inset door  
Петля SOLID, внутренняя

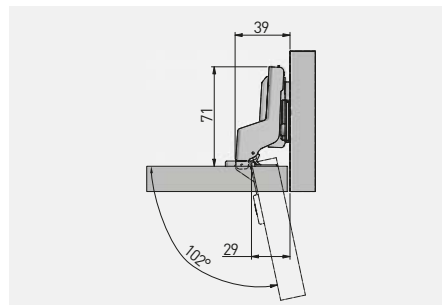

|                 |       |   |   |                            |                        |
|-----------------|-------|---|---|----------------------------|------------------------|
|                 |       |   |   |                            |                        |
| ZP-BIDI07-3DBEO | H = 0 | — | — | nikiel<br>nickel<br>никель | stal<br>steel<br>сталь |



\*Produkt dostępny na indywidualne zamówienie / Available for special orders / Товар доступен под заказ

Zawias CONL, nakładany  
Hinge CONL, overlay door  
Петля CONL, накладная

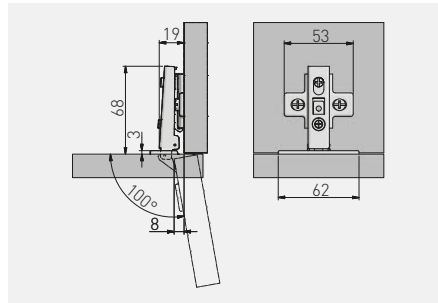

|              |       |   |     |                            |                        |
|--------------|-------|---|-----|----------------------------|------------------------|
|              |       |   |     |                            |                        |
| ZP-CONL09-BE | H = 0 | — | —   | nikiel<br>nickel<br>никель | stal<br>steel<br>сталь |
| ZP-CONL09-ZE |       | — | x 2 |                            |                        |



\*Produkt dostępny na indywidualne zamówienie / Available for special orders / Товар доступен под заказ

Zawias CONL, bliźniaczy  
Hinge CONL, twin overlay door  
Петля CONL, полунакладная

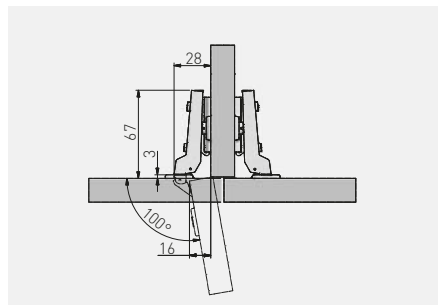

|              |       |   |     |                            |                        |
|--------------|-------|---|-----|----------------------------|------------------------|
|              |       |   |     |                            |                        |
| ZP-CONL08-BE | H = 0 | — | —   | nikiel<br>nickel<br>никель | stal<br>steel<br>сталь |
| ZP-CONL08-ZE |       | — | x 2 |                            |                        |



\*Produkt dostępny na indywidualne zamówienie / Available for special orders / Товар доступен под заказ

Zawias CONL, wpuszczany  
Hinge CONL, inset door  
Петля CONL, внутренняя

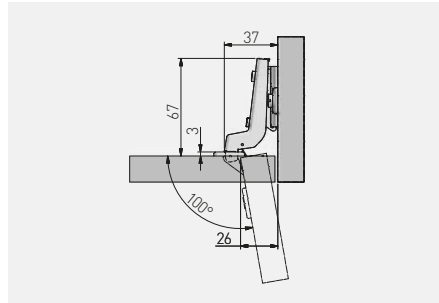

|              |       |   |     |                            |                        |  |
|--------------|-------|---|-----|----------------------------|------------------------|--|
|              |       |   |     |                            |                        |  |
| ZP-CONL07-BE | H = 0 | — | —   | nikiel<br>nickel<br>никель | stal<br>steel<br>сталь |  |
| ZP-CONL07-ZE |       | — | x 2 |                            |                        |  |



\*Produkt dostępny na indywidualne zamówienie / Available for special orders / Товар доступен под заказ

Zawias BICN, nakładany  
Hinge BICN, overlay door  
Петля BICN, накладная

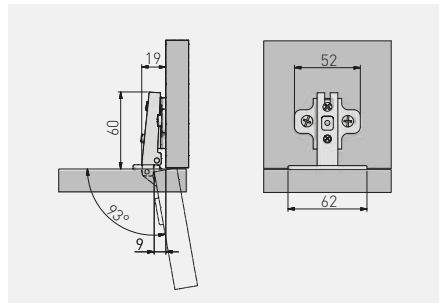

|              |       |   |     |                            |                        |  |
|--------------|-------|---|-----|----------------------------|------------------------|--|
|              |       |   |     |                            |                        |  |
| ZP-BICN090BE | H = 0 | — | —   | nikiel<br>nickel<br>никель | stal<br>steel<br>сталь |  |
| ZP-BICN090ZE |       | — | x 2 |                            |                        |  |
| ZP-BICN092BE | H = 2 | — | —   | nikiel<br>nickel<br>никель | stal<br>steel<br>сталь |  |
| ZP-BICN092ZE |       | — | x 2 |                            |                        |  |



\*Produkt dostępny na indywidualne zamówienie / Available for special orders / Товар доступен под заказ

Zawias BICN, bliźniaczy  
Hinge BICN, twin overlay door  
Петля BICN, полунакладная

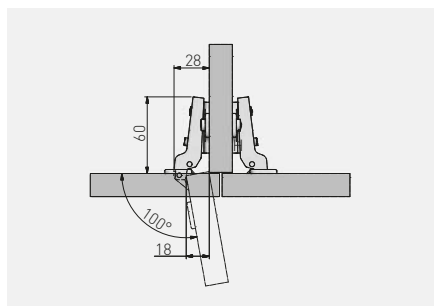

|              |       |   |     |                            |                        |  |  |
|--------------|-------|---|-----|----------------------------|------------------------|--|--|
|              |       |   |     |                            |                        |  |  |
| ZP-BICN080BE | H = 0 | — | —   | nikiel<br>nickel<br>никель | stal<br>steel<br>сталь |  |  |
| ZP-BICN080ZE |       | — | x 2 |                            |                        |  |  |
| ZP-BICN082BE | H = 2 | — | —   |                            |                        |  |  |
| ZP-BICN082ZE |       | — | x 2 |                            |                        |  |  |



\*Produkt dostępny na indywidualne zamówienie / Available for special orders / Товар доступен под заказ

Zawias BICN, wpuszczany  
Hinge BICN, inset door  
Петля BICN, внутренняя

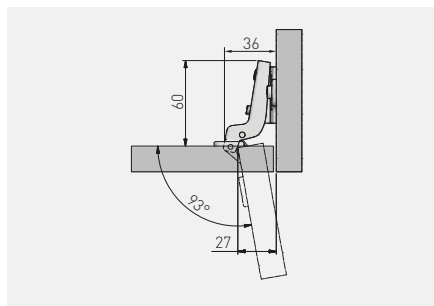

|              |       |   |     |                            |                        |  |  |
|--------------|-------|---|-----|----------------------------|------------------------|--|--|
|              |       |   |     |                            |                        |  |  |
| ZP-BICN070BE | H = 0 | — | —   | nikiel<br>nickel<br>никель | stal<br>steel<br>сталь |  |  |
| ZP-BICN070ZE |       | — | x 2 |                            |                        |  |  |
| ZP-BICN072BE | H = 2 | — | —   |                            |                        |  |  |
| ZP-BICN072ZE |       | — | x 2 |                            |                        |  |  |



\*Produkt dostępny na indywidualne zamówienie / Available for special orders / Товар доступен под заказ

Zawias kątowy 30° KT  
 Corner hinge 30° KT  
 Угловая петля 30° KT

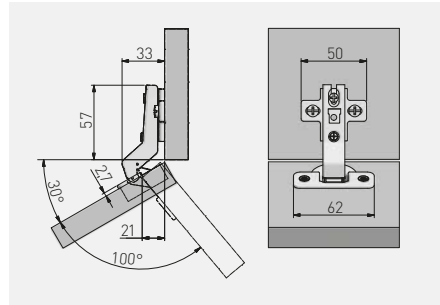

|              |       |   |   |                            |                        |
|--------------|-------|---|---|----------------------------|------------------------|
|              |       |   |   |                            |                        |
| ZP-KT30H2-BE | H = 2 | — | — | nikiel<br>nickel<br>никель | stal<br>steel<br>сталь |



Zawias kątowy 45° KT  
 Corner hinge 45° KT  
 Угловая петля 45° KT

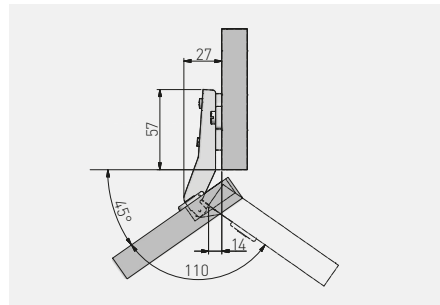

|              |       |   |     |                            |                        |
|--------------|-------|---|-----|----------------------------|------------------------|
|              |       |   |     |                            |                        |
| ZP-KT45H2-BE | H = 2 | — | —   | nikiel<br>nickel<br>никель | stal<br>steel<br>сталь |
| ZP-KT45H2-ZE |       | — | x 2 |                            |                        |



Zawias równoległy KT  
Parallel hinge KT  
Петля под фальшпанель KT

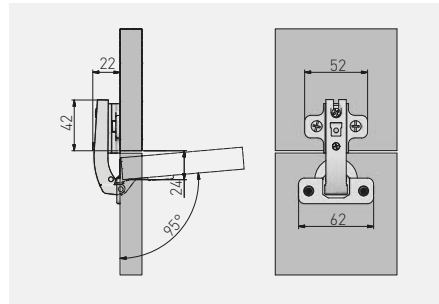

|              |       |   |     |                            |                        |
|--------------|-------|---|-----|----------------------------|------------------------|
|              |       |   |     |                            |                        |
| ZP-KT90H2-BE | H = 2 | — | —   | nikiel<br>nickel<br>нικель | stal<br>steel<br>сталь |
| ZP-KT90H2-ZE |       | — | x 2 |                            |                        |



Zawias równoległy – krótkie ramię KTK  
Parallel hinge – short arm KTK  
Петля под фальшпанель с коротким плечем KTK

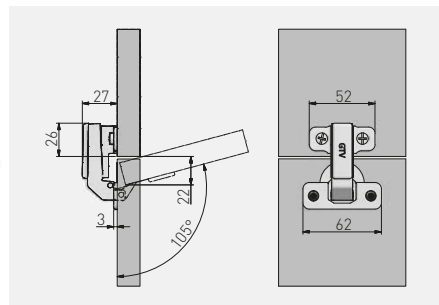

|              |       |   |     |                            |                        |
|--------------|-------|---|-----|----------------------------|------------------------|
|              |       |   |     |                            |                        |
| ZP-KTK90H6BE | H = 6 | — | —   | nikiel<br>nickel<br>нικель | stal<br>steel<br>сталь |
| ZP-KTK90H6ZE |       | — | x 2 |                            |                        |



Zawias 165° KT  
Hinge 165° KT  
Петля 165° KT

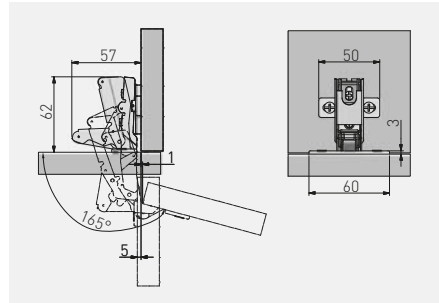

|              |       |   |     |                  |                |
|--------------|-------|---|-----|------------------|----------------|
|              |       |   |     |                  |                |
| ZP-KT165H2BE | H = 2 | — | —   | nikiel           | stal           |
| ZP-KT165H2ZE |       | — | x 2 | nikiel<br>nikель | steel<br>сталь |



Zawias uzupełniający 135° KT  
Complementary hinge 135° KT  
Петля для складных дверей 135° KT

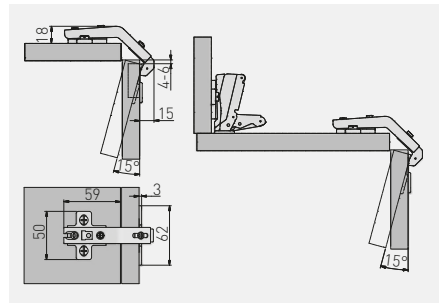

|              |       |   |     |                  |                            |
|--------------|-------|---|-----|------------------|----------------------------|
|              |       |   |     |                  |                            |
| ZP-KT135H2BE | H = 2 | — | —   | nikiel           | stal, ZnAl                 |
| ZP-KT135H2ZE |       | — | x 2 | nikiel<br>никель | steel, ZnAl<br>сталь, ZnAl |





Zawias bez sprężyny COCA, nakładany  
Hinge without spring COCA, overlay door  
Петля без пружины COCA, накладная

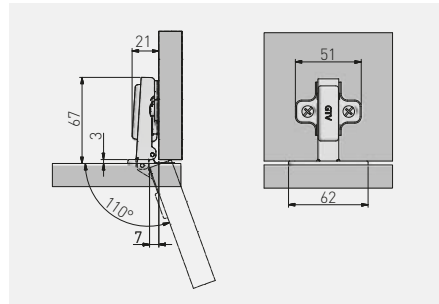

|               |       |   |     |                  |               |
|---------------|-------|---|-----|------------------|---------------|
|               |       |   |     |                  |               |
| ZP-COCA450-BE | H = 0 | — | —   | nikiel<br>nickel | stal<br>steel |
| ZP-COCA450-ZE |       | — | x 2 | nikiel<br>nickel | stal<br>steel |



Zawias bez sprężyny COCA, bliźniaczy  
Hinge without spring COCA, twin overlay door  
Петля без пружины COCA, полунакладная

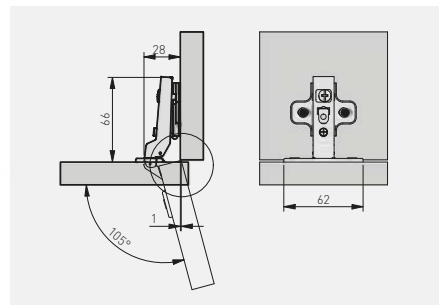

|                |       |   |   |                  |               |
|----------------|-------|---|---|------------------|---------------|
|                |       |   |   |                  |               |
| ZP-COCA8450-BE | H = 0 | — | — | nikiel<br>nickel | stal<br>steel |



Zawias bez sprężyny COCA, wpuszczany  
 Hinge without spring COCA, inset door  
 Петля без пружины COCA, внутренняя

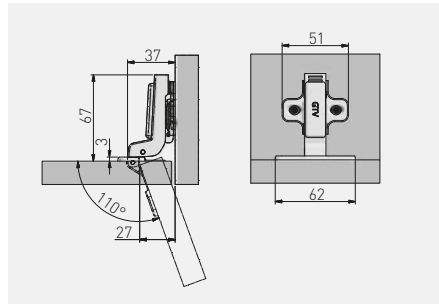

|                |       |   |   |                            |                        |
|----------------|-------|---|---|----------------------------|------------------------|
|                |       |   |   |                            |                        |
| ZP-COCA7450-BE | H = 0 | — | — | nikiel<br>nickel<br>никель | stal<br>steel<br>сталь |



Zawias bez sprężyny COCA, nakładany  
 Hinge without spring COCA, overlay door  
 Петля без пружины COCA, накладная

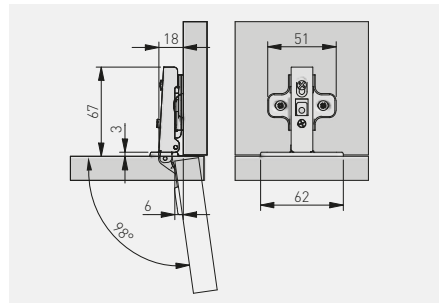

|                 |       |   |   |                            |                        |
|-----------------|-------|---|---|----------------------------|------------------------|
|                 |       |   |   |                            |                        |
| ZP-COCA450-BE-F | H = 0 | — | — | nikiel<br>nickel<br>никель | stal<br>steel<br>сталь |



Zawias bez sprężyny COCA, bliźniaczy  
Hinge without spring COCA, twin overlay door  
Петля без пружины СОСА, полунакладная

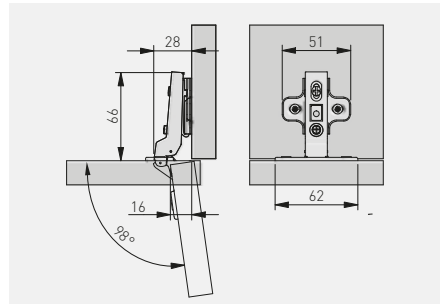

|                  |       |   |   |                            |                        |
|------------------|-------|---|---|----------------------------|------------------------|
|                  |       |   |   |                            |                        |
| ZP-COCA8450-BE-F | H = 0 | — | — | nikiel<br>nickel<br>никель | stal<br>steel<br>сталь |



Zawias bez sprężyny COCA, wpuszczany  
Hinge without spring COCA, inset door  
Петля без пружины СОСА, внутренняя

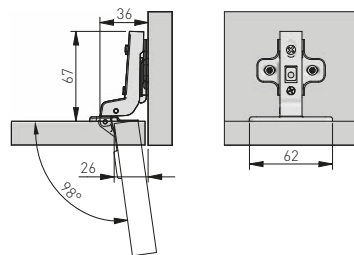

|                  |       |   |   |                            |                        |
|------------------|-------|---|---|----------------------------|------------------------|
|                  |       |   |   |                            |                        |
| ZP-COCA7450-BE-F | H = 0 | — | — | nikiel<br>nickel<br>никель | stal<br>steel<br>сталь |



Zawias samootwierający PO, nakładany  
 Self-opening hinge PO, overlay door  
 Петля с пружиной обратного действия PO, накладная

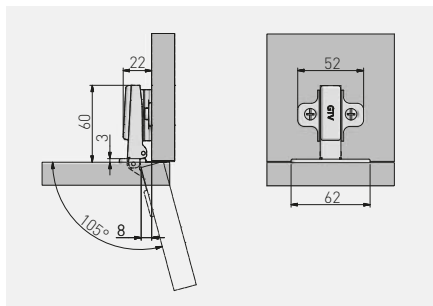

|              |       |   |     |                  |                |
|--------------|-------|---|-----|------------------|----------------|
|              |       |   |     |                  |                |
| ZP-POH045BEO | H = 0 | — | —   | nikiel           | stal           |
| ZP-POH045ZEO |       | — | x 2 | nickel<br>ннкель | steel<br>сталь |



Zawias samootwierający PO, wpuszczany  
 Self-opening hinge PO, inset door  
 Петля с пружиной обратного действия PO, внутренняя

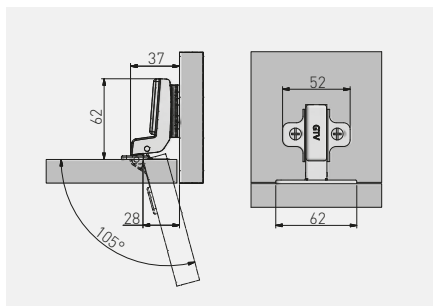

|              |       |   |   |                  |                |
|--------------|-------|---|---|------------------|----------------|
|              |       |   |   |                  |                |
| ZP-P07H045BE | H = 0 | — | — | nikiel           | stal           |
|              |       |   |   | nickel<br>ннкель | steel<br>сталь |



Zawias hydrauliczny mini CIHC, nakładany  
 Hydraulic hinge mini CIHC, overlay door  
 Гидравлическая петля мини CIHC, накладная

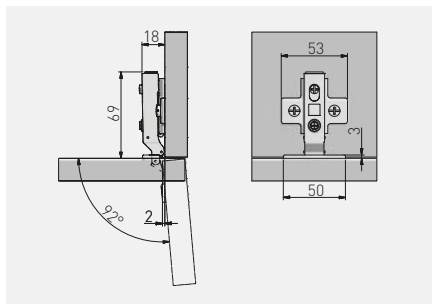

|              |       |     |     |                            |  |
|--------------|-------|-----|-----|----------------------------|--|
|              |       |     |     |                            |  |
| ZP-CIHC090ZE | H = 0 | x 2 | x 2 | nikiel<br>nickel<br>нικель | stal, ZnAl<br>steel, ZnAl<br>сталь, ZnAl |



Zawias hydrauliczny mini CIHC, bliźniaczy  
 Hydraulic hinge mini CIHC, twin overlay door  
 Гидравлическая петля мини CIHC, полунакладная

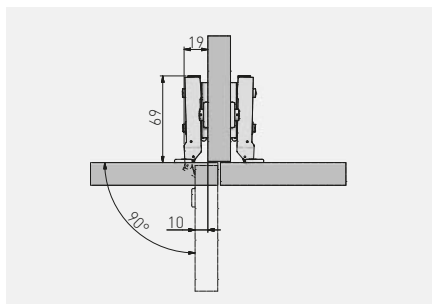

|              |       |     |     |                            |  |
|--------------|-------|-----|-----|----------------------------|--|
|              |       |     |     |                            |  |
| ZP-CIHC080ZE | H = 0 | x 2 | x 2 | nikiel<br>nickel<br>нικель | stal, ZnAl<br>steel, ZnAl<br>сталь, ZnAl |



Zawias hydrauliczny mini CIHC, wpuszczany  
 Hydraulic hinge mini CIHC, inset door  
 Гидравлическая петля мини CIHC, внутренняя

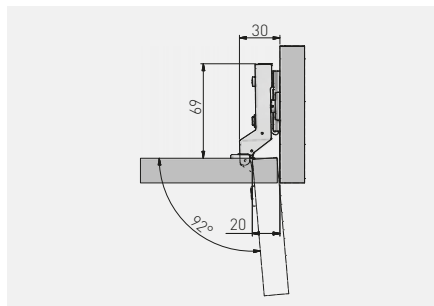

|              |       |     |     |                            |  |
|--------------|-------|-----|-----|----------------------------|--|
|              |       |     |     |                            |  |
| ZP-CIHC070ZE | H = 0 | x 2 | x 2 | nikiel<br>nickel<br>нικель | stal, ZnAl<br>steel, ZnAl<br>сталь, ZnAl |



Zawias mini CIBI, nakładany  
 Hinge mini CIBI, overlay door  
 Петля мини CIBI, накладная

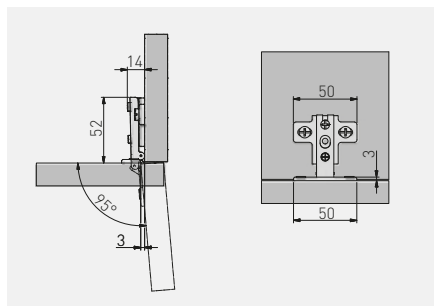

|              |       |   |     |                            |                        |
|--------------|-------|---|-----|----------------------------|------------------------|
|              |       |   |     |                            |                        |
| ZP-CIBI9H0ZE | H = 0 | - | x 2 | nikiel<br>nickel<br>нικель | stal<br>steel<br>сталь |



Zawias mini CIBI, bliźniaczy  
Hinge mini CIBI, twin overlay door  
Петля мини CIBI, полунакладная

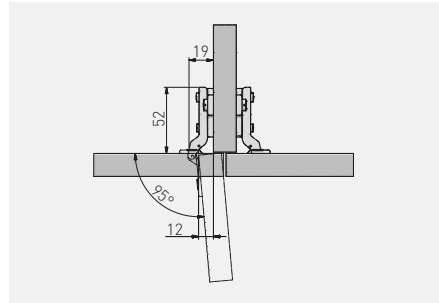

|              |       |   |     |                            |                        |
|--------------|-------|---|-----|----------------------------|------------------------|
|              |       |   |     |                            |                        |
| ZP-CIBI8H0ZE | H = 0 | - | x 2 | nikiel<br>nickel<br>никель | stal<br>steel<br>сталь |



Zawias mini CIBI, wpuszczany  
Hinge mini CIBI, inset door  
Петля мини CIBI, внутренняя

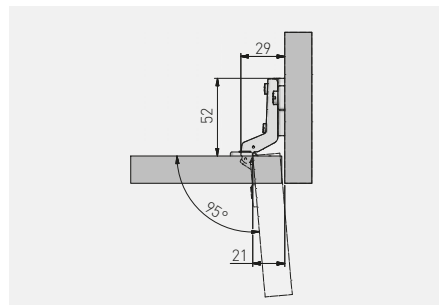

|              |       |   |     |                            |                        |
|--------------|-------|---|-----|----------------------------|------------------------|
|              |       |   |     |                            |                        |
| ZP-CIBI7H0ZE | H = 0 | - | x 2 | nikiel<br>nickel<br>никель | stal<br>steel<br>сталь |



Zawias do szkła CIG, nakładany  
Hinge for glass CIG, overlay door  
Петля для стеклянных фасадов CIG, накладная

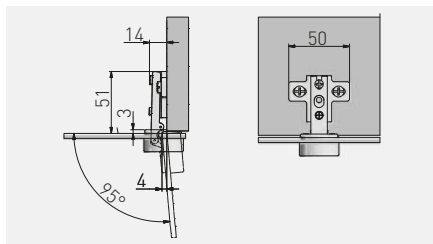

|              |       |   |     |                            |   |  |                         |                                    |
|--------------|-------|---|-----|----------------------------|---|--|-------------------------|------------------------------------|
|              |       |   |     |                            |   |  |                         |                                    |
| ZP-CIG-090ZE | H = 0 | — | x 2 | nikiel<br>nickel<br>нικель | stal, tworzywo<br>steel, plastic<br>сталь, пластмасса |  | chrom<br>chrome<br>хром |                                    |
| ZP-CIG-09UZE |       | — | x 2 |                            |   |  |                         |                                    |
| ZP-CIG-09UBE |       | — | —   |                            |   |  | czarny / black / чёрный |                                    |
| ZP-CIG-09UZC |       | — | x 2 |                            |   |  |                         |                                    |
| ZP-CIG-190ZE |       | — | x 2 |                            |   |  |                         | aluminium<br>aluminium<br>алюминий |
| ZP-CIG-19UZE |       | — | x 2 |                            |   |  |                         |                                    |



Zawias do szkła CIG, wpuszczany  
Hinge for glass CIG, inset door  
Петля для стеклянных фасадов CIG, внутренняя

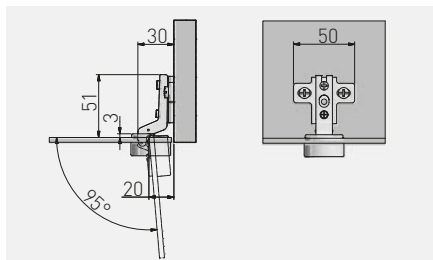

|              |       |   |     |                            |   |  |                                    |
|--------------|-------|---|-----|----------------------------|---|--|------------------------------------|
|              |       |   |     |                            |   |  |                                    |
| ZP-CIG-070ZE | H = 0 | — | x 2 | nikiel<br>nickel<br>нικель | stal, tworzywo<br>steel, plastic<br>сталь, пластмасса |  | chrom<br>chrome<br>хром            |
| ZP-CIG-07UZE |       | — | x 2 |                            |   |  |                                    |
| ZP-CIG-170ZE |       | — | x 2 |                            |   |  | aluminium<br>aluminium<br>алюминий |
| ZP-CIG-17UZE |       | — | x 2 |                            |   |  |                                    |





Zawias do ramek aluminiowych, nakładany  
 Hinge for aluminium frames, overlay door  
 Петля GTV для алюминиевых рамок, с клипом, накладная

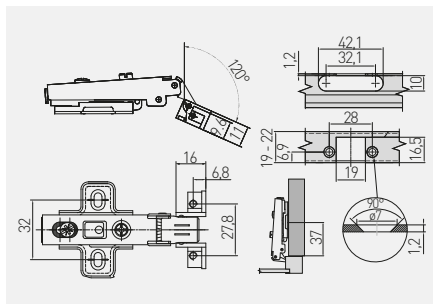

Produkt kompatybilny z profilem aluminiowym do frontów: PA-3731-35-50  
 Product compatible with aluminum profile for fronts: PA-3731-35-50  
 Подходит для алюминиевых профилей под индексом: PA-3731-35-50

|              |       |   |   |                            |                        |
|--------------|-------|---|---|----------------------------|------------------------|
|              |       |   |   |                            |                        |
| ZP-RALUH2-00 | H = 2 | — | — | nikiel<br>nickel<br>никель | stal<br>steel<br>сталь |
|              |       |   |   |                            |                        |
|              |       |   |   |                            |                        |

Zawias hydrauliczny do ramek aluminiowych, nakładany  
 Hinge for aluminium frame, overlay door  
 Петля GTV для алюминиевых рамок, с клипом, накладная

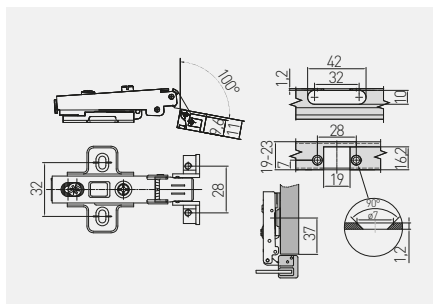

Produkt kompatybilny z profilem aluminiowym do frontów: PA-3731-35-50  
 Product compatible with aluminum profile for fronts: PA-3731-35-50  
 Подходит для алюминиевых профилей под индексом: PA-3731-35-50

|              |       |   |   |                            |                        |
|--------------|-------|---|---|----------------------------|------------------------|
|              |       |   |   |                            |                        |
| ZM-HCRALU9BE | H = 0 | — | — | nikiel<br>nickel<br>никель | stal<br>steel<br>сталь |
|              |       |   |   |                            |                        |
|              |       |   |   |                            |                        |

Zawias 270°, nakładany  
Hinge 270°, overlay door  
Петля 270°, накладная

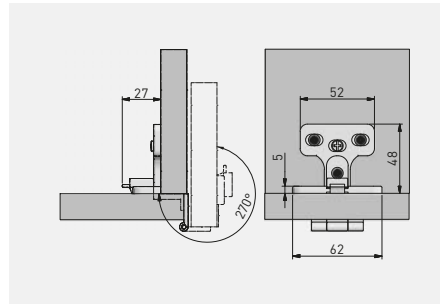

|              |   |   |                            |           |
|--------------|---|---|----------------------------|-----------|
|              |   |   |                            |           |
| ZP-KT0270-BE | — | — | nikiel<br>nickel<br>никель | ZnAl      |
|              |   |   |                            |           |
|              |   |   | CLIP-ON                    | x 100     |
|              |   |   |                            | <b>3D</b> |

Zawias tłoczkowy duży  
Cylinder hinge large  
Поршневая петля (большая)

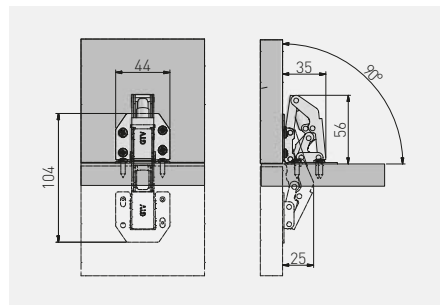

|              |   |   |                            |                        |
|--------------|---|---|----------------------------|------------------------|
|              |   |   |                            |                        |
| ZT-HF-01-D00 | — | — | nikiel<br>nickel<br>никель | stal<br>steel<br>сталь |
|              |   |   |                            |                        |

Zawias tłoczkowy mały  
 Cylinder hinge small  
 Поршневая петля (малая)

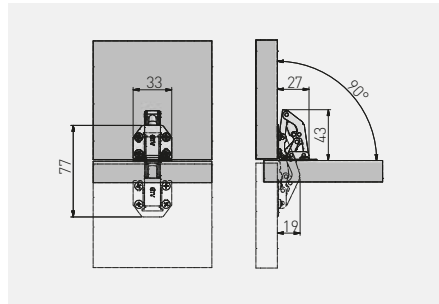

|              |   |   |                            |                        |
|--------------|---|---|----------------------------|------------------------|
|              |   |   |                            |                        |
| ZT-HF-01-M00 | — | — | nikiel<br>nickel<br>никель | stal<br>steel<br>сталь |



Zawias JUNIOR 75°  
 JUNIOR hinge 75°  
 Петля JUNIOR 75°

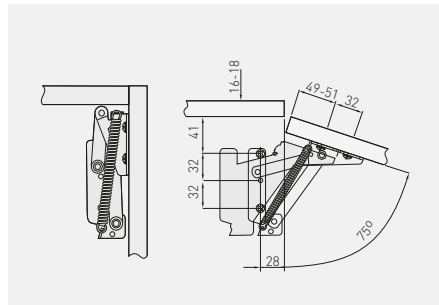

|              |   |   |                            |                        |
|--------------|---|---|----------------------------|------------------------|
|              |   |   |                            |                        |
| ZP-JUNIOR-00 | — | — | nikiel<br>nickel<br>никель | stal<br>steel<br>сталь |



Zawias skrzydełkowy  
Butterfly hinge  
Петля-бабочка

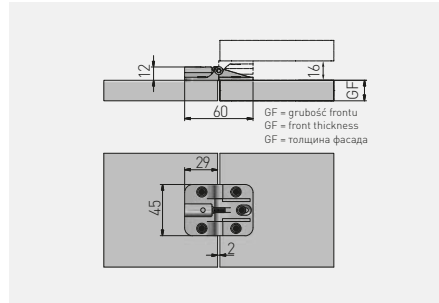

|              |   |   |                          |                        |      |
|--------------|---|---|--------------------------|------------------------|------|
|              |   |   |                          |                        |      |
| ZP-SKR-00-80 | — | — | lakier<br>lacquer<br>лак | szary<br>gray<br>серый | ZnAl |



Zawias cylindryczny  
Cylinder hinge  
Петля цилиндрическая

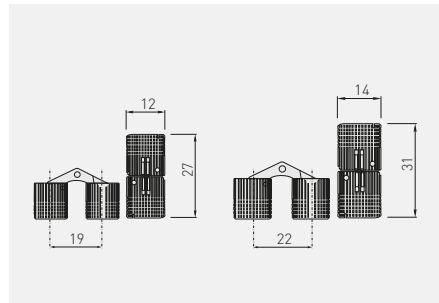

|              |   |    |   |                            |                            |
|--------------|---|----|---|----------------------------|----------------------------|
|              |   |    |   |                            |                            |
| ZC-GTV-12-00 | 1 kpl. = 2 szt.<br>1 set = 2 pcs<br>1 комп. = 2 шт. | 12 | 7 | mosiądz<br>brass<br>латунь | mosiądz<br>brass<br>латунь |
| ZC-GTV-14-00 |   | 14 |   |                            |                            |



Zawias barkowy  
Flap hinge  
Барная петля

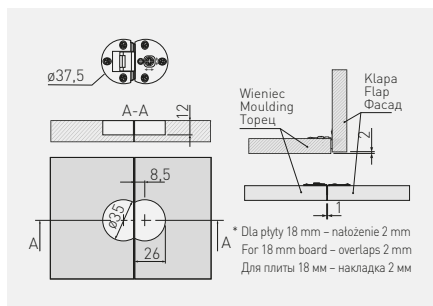

|                 |                                  |  |      |
|-----------------|----------------------------------|--|------|
| PD-MD-ZB-01-KPL | 1 kpl. = 2 szt.<br>1 set = 2 pcs | chrom / chrome / хром                              | ZnAl |
| PD-MD-ZB-04-KPL | 1 комп. = 2 шт.                  | antyczny mosiądz / antique brass / античная латунь |      |



Szablon wiertarski do zawiasów  
Drilling template for hinges  
Шаблон для установки мебельных петель

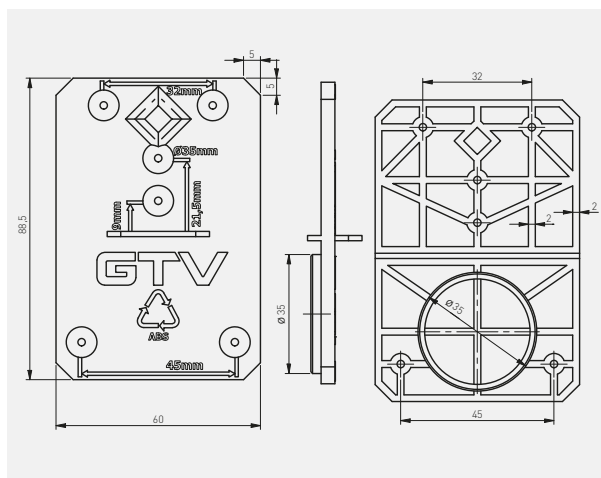

|                |                                 |
|----------------|---------------------------------|
| ZM-SZABLON-ZAW | tworzywo / plastic / пластмасса |
|----------------|---------------------------------|

Amortyzator z adapterem krzyżakowym  
 Buffer with cross adapter  
 Амортизатор с крестовым адаптером

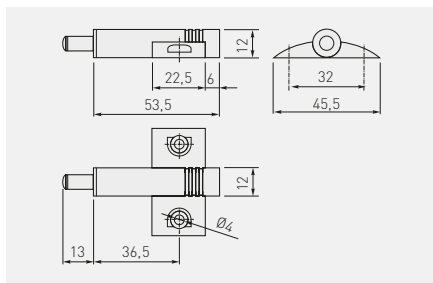

|              |                        |                                   |
|--------------|------------------------|-----------------------------------|
| AM-KRZYZ-KPL | szary<br>gray<br>серый | tworzywo<br>plastic<br>пластмасса |
|--------------|------------------------|-----------------------------------|



Amortyzator AM-ODB  
 Buffer AM-ODB  
 Амортизатор AM-ODB

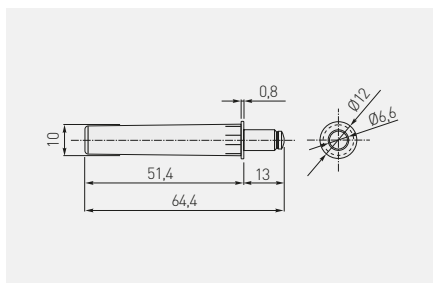

|              |          |                       |                                 |
|--------------|----------|-----------------------|---------------------------------|
| AM-ODB000-60 | standard | szary / gray / серый  | tworzywo / plastic / пластмасса |
| AM-ODB000-10 |          | biały / white / белый |                                 |



Adapter AM-ODB prosty  
 Adapter AM-ODB straight  
 Адаптер AM-ODB прямой

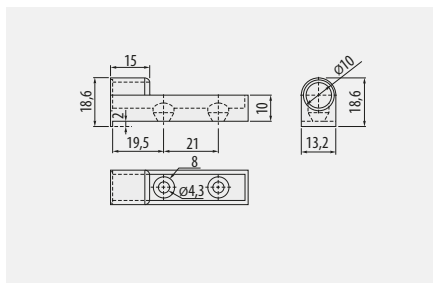

|              |                       |                                 |
|--------------|-----------------------|---------------------------------|
| AM-ADAP0B-60 | szary / gray / серый  | tworzywo / plastic / пластмасса |
| AM-ADAP0B-10 | biały / white / белый |                                 |



Adapter AM-ODB krzyżakowy  
 Cross adapter AM-ODB  
 Адаптер AM-ODB крестовой

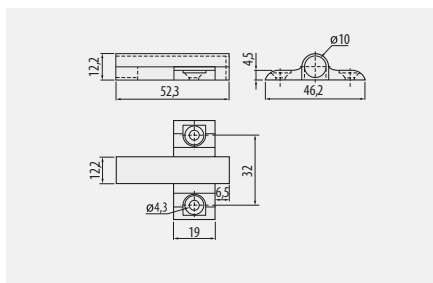

|              |                       |                                 |
|--------------|-----------------------|---------------------------------|
| AM-ADAP0A-60 | szary / gray / серый  | tworzywo / plastic / пластмасса |
| AM-ADAP0A-10 | biały / white / белый |                                 |



Odbojnik SALTO wpuszczany krótki  
Bumper SALTO, recessed, short  
Толкатель SALTO врезной короткий

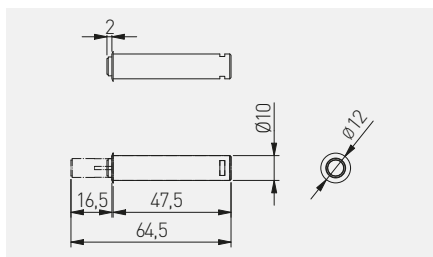

|                 |   |                                    |          |                                |
|-----------------|---|------------------------------------|----------|--------------------------------|
| AM-OWM-KR-MG-10 | z końcówką magnetyczną / magnetic tip / магнитный наконечник    | biały<br>white<br>белый            | min. 3,5 | tworzywo plastic<br>пластмасса |
| AM-OWM-KR-GM-10 | z końcówką kauczukową / with rubber tip / каучуковый наконечник |                                    |          |                                |
| AM-OWM-KR-MG-30 | z końcówką magnetyczną / magnetic tip / магнитный наконечник    | szary<br>gray<br>серый             | min. 3,5 | tworzywo plastic<br>пластмасса |
| AM-OWM-KR-GM-30 | z końcówką kauczukową / with rubber tip / каучуковый наконечник |                                    |          |                                |
| AM-OWM-KR-MG-60 | z końcówką magnetyczną / magnetic tip / магнитный наконечник    | antracyt<br>anthracite<br>антрацит | min. 3,5 | tworzywo plastic<br>пластмасса |
| AM-OWM-KR-GM-60 | z końcówką kauczukową / with rubber tip / каучуковый наконечник |                                    |          |                                |



Odbojnik SALTO wpuszczany długi  
Bumper SALTO, recessed, long  
Толкатель SALTO врезной длинный

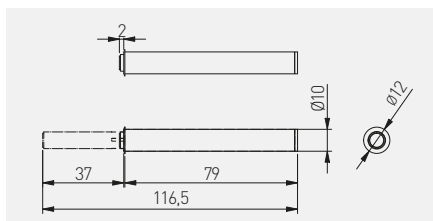

|                 |   |                                    |          |                                |
|-----------------|---|------------------------------------|----------|--------------------------------|
| AM-OWM-DL-MG-10 | z końcówką magnetyczną / magnetic tip / магнитный наконечник    | biały<br>white<br>белый            | min. 3,5 | tworzywo plastic<br>пластмасса |
| AM-OWM-DL-GM-10 | z końcówką kauczukową / with rubber tip / каучуковый наконечник |                                    |          |                                |
| AM-OWM-DL-MG-30 | z końcówką magnetyczną / magnetic tip / магнитный наконечник    | szary<br>gray<br>серый             | min. 3,5 | tworzywo plastic<br>пластмасса |
| AM-OWM-DL-GM-30 | z końcówką kauczukową / with rubber tip / каучуковый наконечник |                                    |          |                                |
| AM-OWM-DL-MG-60 | z końcówką magnetyczną / magnetic tip / магнитный наконечник    | antracyt<br>anthracite<br>антрацит | min. 3,5 | tworzywo plastic<br>пластмасса |
| AM-OWM-DL-GM-60 | z końcówką kauczukową / with rubber tip / каучуковый наконечник |                                    |          |                                |





Odbojnik AM-PL z adapterem  
 Bumper with adapter AM-PL  
 Толкатель с адаптером AM-PL

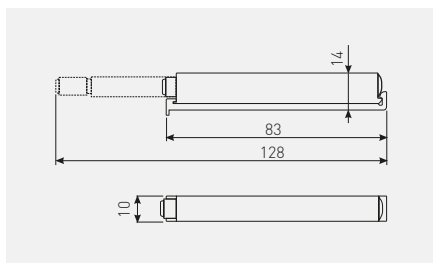

| AM-PL-DL-MAG | z końcówką magnetyczną<br>magnetic tip<br>магнитный наконечник    | szary<br>gray<br>серый | min. 2,5 | tworzywo<br>plastic<br>пластмасса |
|--------------|---|------------------------|----------|-----------------------------------|
| AM-PLA-DLU-0 | z końcówką kauczukową<br>with rubber tip<br>каучуковый наконечник |                        | min. 4,5 |                                   |



Odbojnik AM-PL z adapterem  
 Bumper with adapter AM-PL  
 Толкатель с адаптером AM-PL

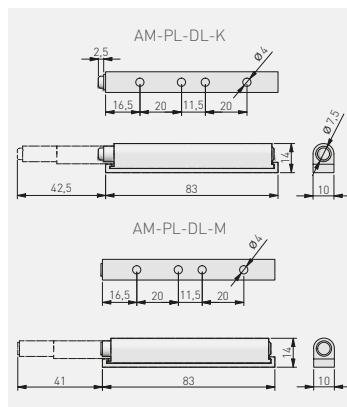

| AM-PL-DL-M | z końcówką magnetyczną<br>magnetic tip<br>магнитный наконечник    | szary<br>gray<br>серый | min. 2,5 | tworzywo<br>plastic<br>пластмасса |
|------------|---|------------------------|----------|-----------------------------------|
| AM-PL-DL-K | z końcówką kauczukową<br>with rubber tip<br>каучуковый наконечник |                        | min. 3,5 |                                   |



Odbojnik SALTO krótki z adapterem  
Bumper SALTO, short, with adapter  
Толкатель SALTO короткий с адаптером

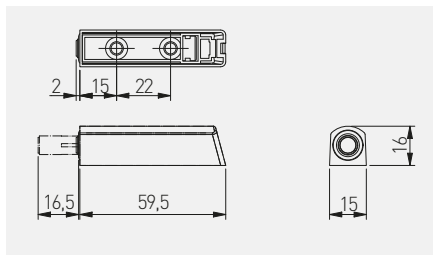

|                 |   |                                    |             |                                   |
|-----------------|---|------------------------------------|-------------|-----------------------------------|
| AM-OAM-KR-MG-10 | z końcówką magnetyczną / magnetic tip / магнитный наконечник    | biały<br>white<br>белый            | min.<br>2,5 | tworzywo<br>plastic<br>пластмасса |
| AM-OAM-KR-GM-10 | z końcówką kauczukową / with rubber tip / каучуковый наконечник |                                    |             |                                   |
| AM-OAM-KR-MG-30 | z końcówką magnetyczną / magnetic tip / магнитный наконечник    | szary<br>gray<br>серый             |             |                                   |
| AM-OAM-KR-GM-30 | z końcówką kauczukową / with rubber tip / каучуковый наконечник |                                    |             |                                   |
| AM-OAM-KR-MG-60 | z końcówką magnetyczną / magnetic tip / магнитный наконечник    | antracyt<br>anthracite<br>антрацит |             |                                   |
| AM-OAM-KR-GM-60 | z końcówką kauczukową / with rubber tip / каучуковый наконечник |                                    |             |                                   |



Odbojnik SALTO długi z adapterem  
Bumper SALTO, long, with adapter  
Толкатель SALTO длинный с адаптером

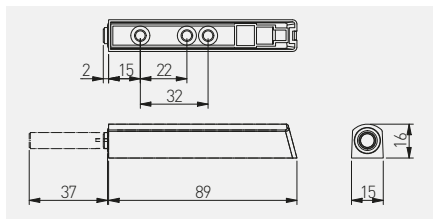

|                 |   |                                    |             |                                   |
|-----------------|---|------------------------------------|-------------|-----------------------------------|
| AM-OAM-DL-MG-10 | z końcówką magnetyczną / magnetic tip / магнитный наконечник    | biały<br>white<br>белый            | min.<br>3,5 | tworzywo<br>plastic<br>пластмасса |
| AM-OAM-DL-GM-10 | z końcówką kauczukową / with rubber tip / каучуковый наконечник |                                    |             |                                   |
| AM-OAM-DL-MG-30 | z końcówką magnetyczną / magnetic tip / магнитный наконечник    | szary<br>gray<br>серый             |             |                                   |
| AM-OAM-DL-GM-30 | z końcówką kauczukową / with rubber tip / каучуковый наконечник |                                    |             |                                   |
| AM-OAM-DL-MG-60 | z końcówką magnetyczną / magnetic tip / магнитный наконечник    | antracyt<br>anthracite<br>антрацит |             |                                   |
| AM-OAM-DL-GM-60 | z końcówką kauczukową / with rubber tip / каучуковый наконечник |                                    |             |                                   |



Odbojnik AM-ZAT zatraskowy  
Push latch AM-ZAT  
Толкатель AM-ZAT на защелке

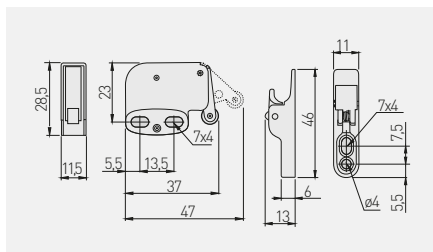

|   |   |   |
|---|---|---|
|  |  |  |
| AM-ZAT-A1-10  | biały<br>white<br>белый   | stal, tworzywo<br>steel, plastic<br>сталь, пластмасса                             |





Do zastosowania z zawiasem samootwierającym ZP-POH045ZE0

Dedicated for GTV self opening hinge ZP-POH045ZE0

Используется с самооткрывающейся петлей ZP-POH045ZE0

Amortyzator silikonowy  
Silicone damper dots  
Амортизатор силиконовый



|   |   |   |
|---|---|---|
|  |  |  |
| AMR-BP-1003   | Ø10 x 3   | 100 szt. / arkusz<br>100 pcs / sheet<br>100 шт. / лист                              |
| AMR-BP-0715   | Ø7 x 1,5  |   |



Podnośnik PD-LIFTNEW  
PD-LIFTNEW lift  
Подъемник PD-LIFTNEW



|                           | Orientacyjna wysokość frontu<br>Approximate front height<br>Ориентировочная высота фасада | Współczynnik F<br>Power Factor F<br>Показатель F | Sprężyna<br>Spring power<br>Пружина |                       |                        |
|---------------------------|---|--|-------------------------------------|-----------------------|------------------------|
| PD-LIFTNEW-LIGHT-10       | 250 – 400 mm  | 480 – 1250                                       | light                               | biały / white / белый | stal<br>steel<br>сталь |
| PD-LIFTNEW-LIGHT-80       |   |  |                                     | szary / gray / серый  |                        |
| PD-LIFTNEW-MEDIUM-10      | 250 – 500 mm  | 960 – 2350                                       | medium                              | biały / white / белый |                        |
| PD-LIFTNEW-MEDIUM-80      |   |  |                                     | szary / gray / серый  |                        |
| PD-LIFTNEW-STRONG-10      | 250 – 500 mm  | 1600 – 3600                                      | strong                              | biały / white / белый |                        |
| PD-LIFTNEW-STRONG-80      |   |  |                                     | szary / gray / серый  |                        |
| PD-LIFTNEW-STRONG-PLUS-10 | 600 mm  | 2500 – 4500                                      | extra strong                        | biały / white / белый |                        |
| PD-LIFTNEW-STRONG-PLUS-80 |   |  |                                     | szary / gray / серый  |                        |

Współczynnik mocy F = wysokość frontu H (mm) × waga frontu łącznie z podwójną wagą uchwytu (kg)

Power Factor F = front height H (mm) × front weight with doubled handle weight (kg)

Показатель мощности F = высота фасада H (мм) × вес фасада с удвоенным весом ручки (кг)

Podnośnik PD-LIFT-P20  
PD-LIFT-P20 lift  
Подъемник PD-LIFT-P20

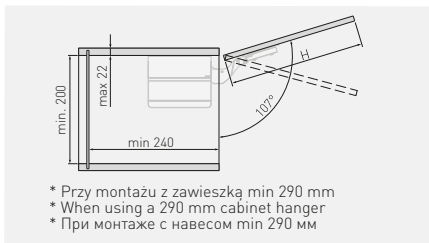

|                            | Orientacyjna wysokość frontu<br>Approximate front height<br>Ориентировочная высота фасада | Współczynnik F<br>Power Factor F<br>Показатель F | Sprężyna<br>Spring power<br>Пружина |                       |                        |
|----------------------------|---|--|-------------------------------------|-----------------------|------------------------|
| PD-LIFT-P20-LIGHT-10       | 250 – 400 mm  | 580 – 1350                                       | light                               | biały / white / белый | stal<br>steel<br>сталь |
| PD-LIFT-P20-LIGHT-80       |   |  |                                     | szary / gray / серый  |                        |
| PD-LIFT-P20-MEDIUM-10      | 250 – 500 mm  | 1060 – 2450                                      | medium                              | biały / white / белый |                        |
| PD-LIFT-P20-MEDIUM-80      |   |  |                                     | szary / gray / серый  |                        |
| PD-LIFT-P20-STRONG-10      | 250 – 500 mm  | 1800 – 4000                                      | strong                              | biały / white / белый |                        |
| PD-LIFT-P20-STRONG-80      |   |  |                                     | szary / gray / серый  |                        |
| PD-LIFT-P20-STRONG-PLUS-10 | 600 mm  | 2600 – 5000                                      | extra strong                        | biały / white / белый |                        |
| PD-LIFT-P20-STRONG-PLUS-80 |   |  |                                     | szary / gray / серый  |                        |

Współczynnik mocy F = wysokość frontu H (mm) × waga frontu łącznie z podwójną wagą uchwytu (kg)

Power Factor F = front height H (mm) × front weight with doubled handle weight (kg)

Показатель мощности F = высота фасада H (мм) × вес фасада с удвоенным весом ручки (кг)

Podnośnik PD-MINILIFTNEW  
 PD-MINILIFTNEW lift  
 Подъемник PD-MINILIFTNEW

NEW

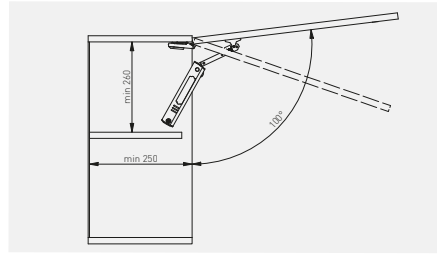

|                          | Wymiary frontu<br>Front dimensions<br>Размеры фасада |                              | Waga frontu<br>Front weight<br>Вес фасада | Zalecana ilość<br>podnośników<br>(szt.)<br>Recommended<br>number of lifts<br>Рекомендуемое<br>количество<br>подъемников<br>(шт.) |                         |               |
|--------------------------|--|------------------------------|---|--|-------------------------|---------------|
|                          | Wysokość<br>Height<br>Высота                         | Szerokość<br>Width<br>Ширина |   |  |                         |               |
| PD-MINILIFTNEW-LIGHT     | 300-400 mm   | 500-800 mm                   | 2-3 kg                                    | 1  | chrom / chrome / хром   | stal<br>steel |
| PD-MINILIFTNEW-LIGHT-20  | 300-400 mm   | 500-1000 mm                  | 3,1-4 kg                                  | 2  | czarny / black / черный |               |
| PD-MINILIFTNEW-MEDIUM    | 300-450 mm   | 500-1000 mm                  | 3,5-4,5 kg                                | 1  | chrom / chrome / хром   | stal<br>steel |
| PD-MINILIFTNEW-MEDIUM-20 | 300-450 mm   | 500-1200 mm                  | 5,5-7,5 kg                                | 2  | czarny / black / черный |               |
| PD-MINILIFTNEW-STRONG    | 380-550 mm   | 500-1200 mm                  | 5-6 kg                                    | 1  | chrom / chrome / хром   | stal<br>steel |
| PD-MINILIFTNEW-STRONG-20 | 380-550 mm   | 500-1200 mm                  | 6,5-10 kg                                 | 2  | czarny / black / черный |               |



Podnośnik gazowy NEO  
Gas stay lift NEO  
Подъемник газовый NEO

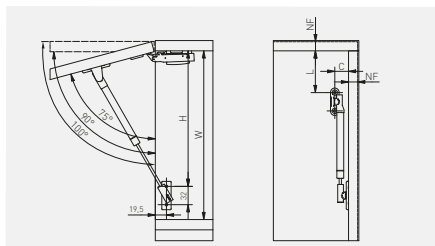

| ø 12   |           |           |           |           |
|--|-----------|-----------|-----------|-----------|
| Kąt otwarcia drzwi<br>Door opening angle<br>Угол открывания дверей | H<br>(mm) | L<br>(mm) | C<br>(mm) | W<br>(mm) |
| 75°  | 237       | 73        | 24        | 275       |
| 90°  | 217       | 54        |           |           |
| ø 15   |           |           |           |           |
| Kąt otwarcia drzwi<br>Door opening angle<br>Угол открывания дверей | H<br>(mm) | L<br>(mm) | C<br>(mm) | W<br>(mm) |
| 75°  | 247       | 73        | 24        | 295       |
| 90°  | 228       | 52        |           |           |

| Model            | Lift force (N) | Color   | Material               |
|------------------|----------------|---|------------------------|
| PD-GNE012-50-60  | 50 N           | szary / antracyt<br>gray / anthracite<br>серый / антрацит | stal<br>steel<br>сталь |
| PD-GNE012-60-60  | 60 N           |   |                        |
| PD-GNE012-80-60  | 80 N           |   |                        |
| PD-GNE012-50-10M | 50 N           | biały<br>white<br>белый                                   |                        |
| PD-GNE012-60-10M | 60 N           |   |                        |
| PD-GNE012-80-10M | 80 N           |   |                        |

| Kąt otwarcia drzwi<br>Door opening angle<br>Угол открывания дверей | Siła podnośnika<br>Lift force<br>Мощность<br>подъемника | Wysokość drzwi (mm) / Door height (mm) / Высота дверцы (мм) |     |     |     |
|--|---|---|-----|-----|-----|
|  |   | 300   | 400 | 500 | 600 |
| Waga drzwi (kg) / Door weight (kg) / Вес дверцы (кг)               |   |   |     |     |     |
| 75°  | 50 N  | 1,6   | 1,2 | 1,0 | 0,8 |
|  | 60 N  | 2,0   | 1,5 | 1,2 | 1,0 |
|  | 80 N  | 2,7   | 2,0 | 1,6 | 1,4 |
|  | 100 N   | 3,4   | 2,6 | 2,0 | 1,7 |
|  | 120 N   | 4,1   | 3,1 | 2,5 | 2,0 |
| 90°  | 50 N  | 1,5   | 1,1 | 0,9 | 0,7 |
|  | 60 N  | 1,8   | 1,3 | 1,1 | 0,9 |
|  | 80 N  | 2,4   | 1,8 | 1,4 | 1,2 |
|  | 100 N   | 3,0   | 2,2 | 1,8 | 1,5 |
|  | 120 N   | 3,6   | 2,7 | 2,1 | 1,8 |
| 100°   | 50 N  | 1,1   | 1,0 | 0,8 | 0,7 |
|  | 60 N  | 1,6   | 1,2 | 0,9 | 0,8 |
|  | 80 N  | 2,1   | 1,6 | 1,2 | 1,0 |
|  | 100 N   | 2,6   | 1,9 | 1,6 | 1,3 |
|  | 120 N   | 3,1   | 2,3 | 1,9 | 1,6 |
|  | 150 N   | 3,5   | 2,6 | 2,2 | 1,9 |

Podnośnik gazowy z amortyzatorem i regulacją  
 Gas stay with buffer, adjustable  
 Подъемник газовый с амортизатором и регулировкой

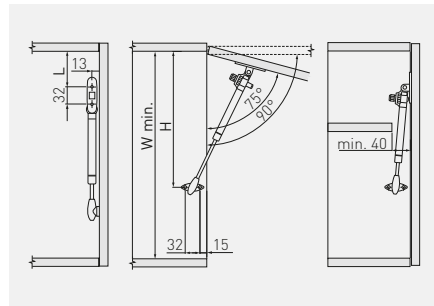

|               |       |                                    |                        |
|---------------|-------|------------------------------------|------------------------|
| PD-GAM050-N02 | 50 N  | szary<br>gray<br>серый             | stal<br>steel<br>сталь |
| PD-GAM060-N02 | 60 N  |                                    |                        |
| PD-GAM080-N02 | 80 N  |                                    |                        |
| PD-GAM100-N02 | 100 N |                                    |                        |
| PD-GAM120-N02 | 120 N |                                    |                        |
| PD-GAM150-N02 | 150 N | biały<br>white<br>белый            |                        |
| PD-GAM050-N10 | 50 N  |                                    |                        |
| PD-GAM060-N10 | 60 N  |                                    |                        |
| PD-GAM080-N10 | 80 N  |                                    |                        |
| PD-GAM100-N10 | 100 N |                                    |                        |
| PD-GAM120-N10 | 120 N | antracyt<br>anthracite<br>антрацит |                        |
| PD-GAM150-N10 | 150 N |                                    |                        |
| PD-GAM050-N60 | 50 N  |                                    |                        |
| PD-GAM060-N60 | 60 N  |                                    |                        |
| PD-GAM080-N60 | 80 N  |                                    |                        |
| PD-GAM100-N60 | 100 N |                                    |                        |
| PD-GAM120-N60 | 120 N |                                    |                        |
| PD-GAM150-N60 | 150 N |                                    |                        |

| Kąt otwarcia drzwi<br>Door opening angle<br>Угол открывания дверей | H<br>(mm) | L<br>(mm) | W<br>(mm) |
|--|-----------|-----------|-----------|
| 75°  | 295       | 64        | 315       |
| 90°  | 275       | 52        | 300       |



| Kąt otwarcia drzwi<br>Door opening angle<br>Угол открывания дверей | Siła podnośnika<br>Lift force<br>Мощность<br>подъемника | Wysokość drzwi (mm) / Door height (mm) / Высота дверцы (мм) |     |     |     |
|--|---|---|-----|-----|-----|
|  |   | 300   | 400 | 500 | 600 |
|  |   | Waga drzwi (kg) / Door weight (kg) / Вес дверцы (кг)        |     |     |     |
| <p>75°</p>   | 50 N  | 1,6   | 1,2 | 1,0 | 0,8 |
|  | 60 N  | 2,0   | 1,5 | 1,2 | 1,0 |
|  | 80 N  | 2,7   | 2,0 | 1,6 | 1,4 |
|  | 100 N   | 3,4   | 2,6 | 2,0 | 1,7 |
|  | 120 N   | 4,1   | 3,1 | 2,5 | 2,0 |
| <p>90°</p>   | 50 N  | 1,5   | 1,1 | 0,9 | 0,7 |
|  | 60 N  | 1,8   | 1,3 | 1,1 | 0,9 |
|  | 80 N  | 2,4   | 1,8 | 1,4 | 1,2 |
|  | 100 N   | 3,0   | 2,2 | 1,8 | 1,5 |
|  | 120 N   | 3,6   | 2,7 | 2,1 | 1,8 |
|  | 150 N   | 4,1   | 3,2 | 2,3 | 2,1 |

Podnośnik gazowy standard  
 Gas stay lift standard  
 Подъемник газовый стандартный



|              |       |                        |                        |
|--------------|-------|------------------------|------------------------|
| PD-G0050-N02 | 50 N  | szary<br>gray<br>серый | stal<br>steel<br>сталь |
| PD-G0060-N02 | 60 N  |                        |                        |
| PD-G0080-N02 | 80 N  |                        |                        |
| PD-G0100-N02 | 100 N |                        |                        |
| PD-G0120-N02 | 120 N |                        |                        |
| PD-G0150-N02 | 150 N |                        |                        |

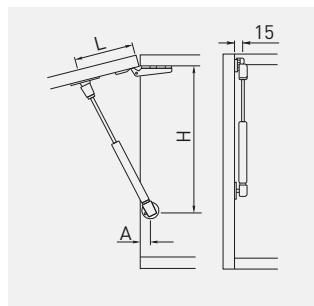

| Kąt otwarcia drzwi<br>Door opening angle<br>Угол открывания дверей | Drzwi wpuszczane<br>Inset door<br>Внутренние дверцы |        |   | Drzwi bliźniacze<br>Twin door<br>Двойные дверцы |        |        | Drzwi nakładane<br>Overlay door<br>Наружные дверцы |        |        |
|--|---|--------|---|---|--------|--------|--|--------|--------|
|  | H (mm)  | L (mm) | A (mm)  | H (mm)  | L (mm) | A (mm) | H (mm)   | L (mm) | A (mm) |
| 75°  | 280   | 100    | 20 + grubość frontu<br>20 + front thicknes<br>20 + толщина фронта | 272   | 100    | 25     | 264  | 100    | 25     |
| 90°  | 260   | 90     |   | 251   | 90     | 25     | 244  | 90     | 25     |
| 100°   | 250   | 80     |   | 242   | 80     | 25     | 234  | 80     | 25     |

| Kąt otwarcia drzwi<br>Door opening angle<br>Угол открывания дверей | Siła podnośnika<br>Lift force<br>Мощность<br>подъемника | Wysokość drzwi (mm) / Door height (mm) / Высота дверцы (мм) |     |     |     |
|--|---|---|-----|-----|-----|
|  |   | 300   | 400 | 500 | 600 |
|  |   | Waga drzwi (kg) / Door weight (kg) / Вес дверцы (кг)        |     |     |     |
| <br>75°  | 60 N  | 2,0   | 1,5 | 1,2 | 1,0 |
|  | 80 N  | 2,7   | 2,0 | 1,6 | 1,4 |
|  | 100 N   | 3,4   | 2,6 | 2,0 | 1,7 |
|  | 120 N   | 4,1   | 3,1 | 2,5 | 2,0 |
|  | 150 N   | 4,7   | 3,5 | 2,9 | 2,4 |
| <br>90°  | 60 N  | 1,8   | 1,3 | 1,1 | 0,9 |
|  | 80 N  | 2,4   | 1,8 | 1,4 | 1,2 |
|  | 100 N   | 3,0   | 2,2 | 1,8 | 1,5 |
|  | 120 N   | 3,6   | 2,7 | 2,1 | 1,8 |
|  | 150 N   | 4,1   | 3,2 | 2,3 | 2,1 |
| <br>100°   | 60 N  | 1,6   | 1,2 | 0,9 | 0,8 |
|  | 80 N  | 2,1   | 1,6 | 1,2 | 1,0 |
|  | 100 N   | 2,6   | 1,9 | 1,6 | 1,3 |
|  | 120 N   | 3,1   | 2,3 | 1,9 | 1,6 |
|  | 150 N   | 3,5   | 2,6 | 2,2 | 1,9 |



Podnośnik gazowy standard  
 Gas stay lift standard  
 Подъёмник газовый стандартный

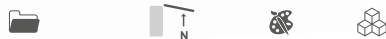

|              |       |                        |                        |
|--------------|-------|------------------------|------------------------|
| PD-G0050-N03 | 50 N  | szary<br>gray<br>серый | stal<br>steel<br>сталь |
| PD-G0060-N03 | 60 N  |                        |                        |
| PD-G0080-N03 | 80 N  |                        |                        |
| PD-G0100-N03 | 100 N |                        |                        |
| PD-G0120-N03 | 120 N |                        |                        |
| PD-G0150-N03 | 150 N |                        |                        |

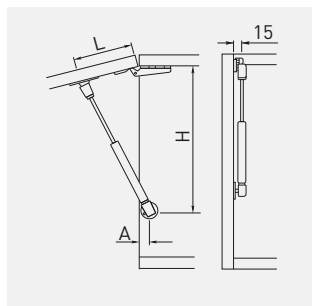

| Kąt otwarcia drzwi<br>Door opening angle<br>Угол открывания дверей | Drzwi nakładane<br>Overlay door<br>Наружные дверцы |        |        |
|--|--|--------|--------|
|  | H (mm)   | L (mm) | A (mm) |
| 75°  | 280  | 72     | 12     |
| 90°  | 237  | 60     |        |
| 100°   | 228  | 52     |        |

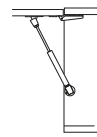
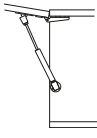
| Kąt otwarcia drzwi<br>Door opening angle<br>Угол открывания дверей                          | Siła podnośnika<br>Lift force<br>Мощность<br>подъёмника | Wysokość drzwi (mm) / Door height (mm) / Высота дверцы (мм) |     |     |     |
|---|---|---|-----|-----|-----|
|   |   | 300   | 400 | 500 | 600 |
|   |   | Waga drzwi (kg) / Door weight (kg) / Вес дверцы (кг)        |     |     |     |
| <br>75°  | 50 N  | 1,6   | 1,2 | 1,0 | 0,8 |
|   | 60 N  | 2,0   | 1,5 | 1,2 | 1,0 |
|   | 80 N  | 2,7   | 2,0 | 1,6 | 1,4 |
|   | 100 N   | 3,4   | 2,6 | 2,0 | 1,7 |
|   | 120 N   | 4,1   | 3,1 | 2,5 | 2,0 |
|   | 150 N   | 4,7   | 3,5 | 2,9 | 2,4 |
| <br>90°  | 50 N  | 1,5   | 1,1 | 0,9 | 0,7 |
|   | 60 N  | 1,8   | 1,3 | 1,1 | 0,9 |
|   | 80 N  | 2,4   | 1,8 | 1,4 | 1,2 |
|   | 100 N   | 3,0   | 2,2 | 1,8 | 1,5 |
|   | 120 N   | 3,6   | 2,7 | 2,1 | 1,8 |
|   | 150 N   | 4,1   | 3,2 | 2,3 | 2,1 |
| <br>100° | 50 N  | 1,1   | 1,0 | 0,8 | 0,7 |
|   | 60 N  | 1,6   | 1,2 | 0,9 | 0,8 |
|   | 80 N  | 2,1   | 1,6 | 1,2 | 1,0 |
|   | 100 N   | 2,6   | 1,9 | 1,6 | 1,3 |
|   | 120 N   | 3,1   | 2,3 | 1,9 | 1,6 |
|   | 150 N   | 3,5   | 2,6 | 2,2 | 1,9 |

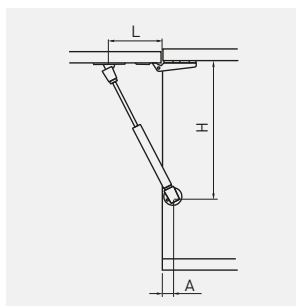

Podnośnik gazowy krótki  
Gas stay lift short  
Подъемник газовый короткий



|              |      |                        |                        |
|--------------|------|------------------------|------------------------|
| PD-G60160-02 | 60 N | szary<br>gray<br>серый | stal<br>steel<br>сталь |
| PD-G80160-02 | 80 N |                        |                        |

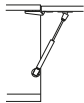

| Kąt otwarcia drzwi<br>Door opening angle<br>Угол открывания дверей | Drzwi wpuszczane<br>Inset door<br>Внутренние дверцы |           |  | Drzwi bliźniacze<br>Twin door<br>Двойные дверцы |           |           | Drzwi nakładane<br>Overlay door<br>Наружные дверцы |           |           |
|--|---|-----------|--|---|-----------|-----------|--|-----------|-----------|
|  | H<br>(mm)   | L<br>(mm) | A<br>(mm)  | H<br>(mm)                                       | L<br>(mm) | A<br>(mm) | H<br>(mm)  | L<br>(mm) | A<br>(mm) |
| 75°  | 188   | 70        | 20 + grubość frontu<br>20 + front thickness<br>20 + толщина фронта | 180   | 70        | 20        | 172  | 70        | 20        |
| 90°  | 176   | 60        |  | 167   | 60        | 20        | 160  | 60        | 20        |
| 100°   | 172   | 50        |  | 164   | 50        | 20        | 154  | 50        | 20        |

| Kąt otwarcia drzwi<br>Door opening angle<br>Угол открывания дверей                          | Siła podnośnika<br>Lift force<br>Мощность<br>подъемника | Wysokość drzwi (mm) / Door height (mm) / Высота дверцы (мм) |     |     |     |
|---|---|---|-----|-----|-----|
|   |   | 300   | 400 | 500 | 600 |
|   |   | Waga drzwi (kg) / Door weight (kg) / Вес дверцы (кг)        |     |     |     |
| 75°<br>  | 60 N  | 2,0   | 1,5 | 1,2 | 1,0 |
|   | 80 N  | 2,7   | 2,0 | 1,6 | 1,4 |
| 90°<br>  | 60 N  | 1,8   | 1,3 | 1,1 | 0,9 |
|   | 80 N  | 2,4   | 1,8 | 1,4 | 1,2 |
| 100°<br> | 60 N  | 1,6   | 1,2 | 0,9 | 0,8 |
|   | 80 N  | 2,1   | 1,6 | 1,2 | 1,0 |

Podnośnik DESIGN mechaniczny  
Mechanical stay lift DESIGN  
Подъемник механический DESIGN



|              |                        |               |
|--------------|------------------------|---------------|
|              |                        |               |
| PD-GPD01-001 | chrom / chrome / хром  | stal<br>steel |
| PD-GPD02-002 | satyna / satin / сатин | stal<br>steel |
| PD-GPD03-005 | aluminium / алюминий   | stal<br>steel |



Podnośnik do klap  
Flap lift  
Подъемник фасада



100°

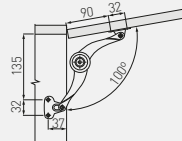

Płaczyszyna wewn. boku  
Inner side surface  
Поверхность боковой стенки

Podnośnik do klap  
Flap lift  
Подъемник фасада



75°

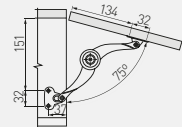

Płaczyszyna wewn. boku  
Inner side surface  
Поверхность боковой стенки

Podnośnik do klap  
Flap lift  
Подъемник фасада



90°

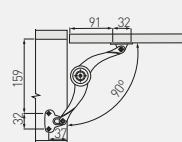

Płaczyszyna wewn. boku  
Inner side surface  
Поверхность боковой стенки

Wizualizacja dla zawiasów barkowych  
Drop Down Flap Stay  
Визуализация для барных петель



90°

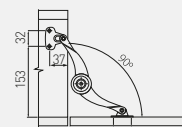

Płaczyszyna wewn. boku  
Inner side surface  
Поверхность боковой стенки

Wykres orientacyjnych wartości maksymalnego ciężaru w zależności od wysokości klapki.

Maximum weight depending on the flap height.

Максимальный вес фасада зависит от его высоты.

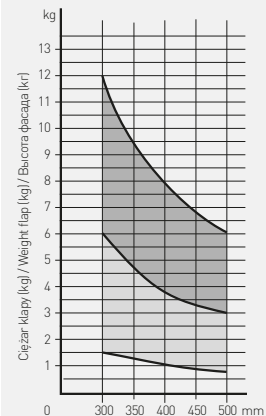
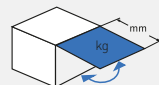

Wysokość klapki (mm)  
Flap height (mm)  
Wysokość фасада (mm)

- 1 podnośnik  
1 stay lift  
1 подъемник
- 2 podnośniki  
2 stay lifts  
2 подъемника

Podnośnik mechaniczny standard  
 Mechanical stay lift standard  
 Подъемник механический стандартный



PD-PD000-001



chrom / chrome / хром



stal / steel / сталь



Podnośnik do klap  
 Flap lift  
 Поддержка фасада



100°

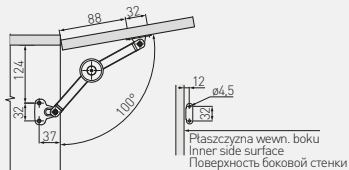

Wykres orientacyjnych wartości maksymalnego ciężaru w zależności od wysokości klap.

Maximum weight depending on the flap height.

Максимальный вес фасада зависит от его высоты.

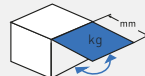

Podnośnik do klap  
 Flap lift  
 Поддержка фасада



75°

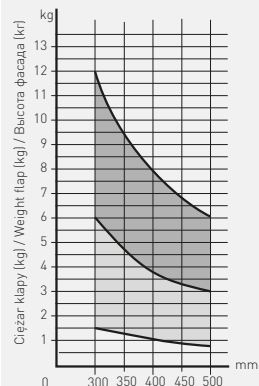
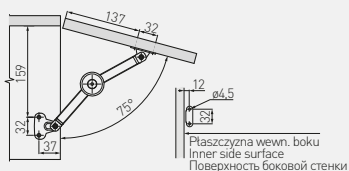

Podnośnik do klap  
 Flap lift  
 Поддержка фасада



90°

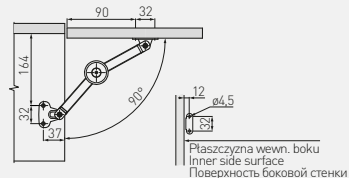

Rozwórka do klap  
 Wizualizacja dla zawiasu barkowego  
 Drop down flap stay  
 Поддержка фасада  
 Визуализация для барных петель



90°

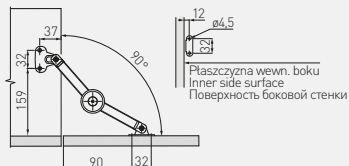

Wysokość klap (mm)  
 Flap height (mm)  
 Высота фасада (мм)

- 1 podnośnik  
1 stay lift  
1 подъемник
- 2 podnośniki  
2 stay lifts  
2 подъемника

Podnośnik mechaniczny standard  
 Mechanical stay lift standard  
 Подъемник механический стандартный



PD-PD000-001B

chrom / chrome / хром

stal / steel / сталь



Podnośnik do klap  
 Flap lift  
 Поддержка фасада



100°

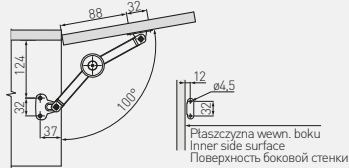

12  $\varnothing$ 4.5  
 Płaszczyzna wewn. boku  
 Inner side surface  
 Поверхность боковой стенки

Podnośnik do klap  
 Flap lift  
 Поддержка фасада



75°

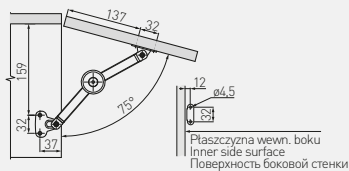

12  $\varnothing$ 4.5  
 Płaszczyzna wewn. boku  
 Inner side surface  
 Поверхность боковой стенки

Podnośnik do klap  
 Flap lift  
 Поддержка фасада



90°

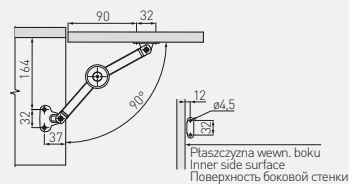

12  $\varnothing$ 4.5  
 Płaszczyzna wewn. boku  
 Inner side surface  
 Поверхность боковой стенки

Rozwórka do klap  
 Wizualizacja dla zawiasu barkowego  
 Drop down flap stay  
 Поддержка фасада  
 Визуализация для барных петель



90°

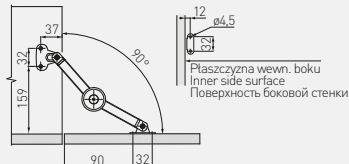

12  $\varnothing$ 4.5  
 Płaszczyzna wewn. boku  
 Inner side surface  
 Поверхность боковой стенки

Wykres orientacyjnych wartości  
 maksymalnego ciężaru w zależności  
 od wysokości klap.

Maximum weight depending  
 on the flap height.

Максимальный вес фасада зависит  
 от его высоты.

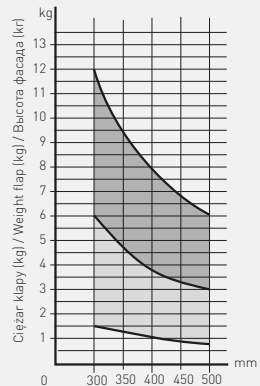
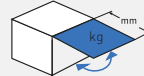

Wysokość klap (mm)  
 Flap height (mm)  
 Wysokość фасада (mm)

- 1 podnośnik  
1 stay lift  
1 подъемник
- 2 podnośniki  
2 stay lifts  
2 подъемника

Amortyzator VIM do klap barkowych, krótki  
 VIM stay lift for drop down cabinet doors, short  
 Амортизатор барный, короткий VIM



Produkt kompatybilny z zawiasem barkowym: PD-MD-ZB  
 Compatible with flap hinge: PD-MD-ZB  
 Продукт совместим с барной петлей: PD-MD-ZB

|   |   |   |
|---|---|---|
|  |  |  |
| PD-MDLIFT-P1-D  | szary<br>gray<br>серый  | stal<br>steel<br>сталь  |



Orientacyjna tabela wartości doboru podnośników, w zależności od szerokości i wysokości klap.  
 Maximum weight depending on the flap width and height.

Таблица подбора амортизатора в зависимости от ширины и высоты фасада.

| Wysokość Height<br>Высота | Szerokość (mm) / Width (mm) /<br>Ширина (мм) |        |        |        |
|---------------------------|--|--------|--------|--------|
|                           | 600 mm                                       | 700 mm | 800 mm | 900 mm |
| 250 mm                    | 1  | 1      | 2      | 2      |
| 260 mm                    |  |        |        |        |
| 270 mm                    |  |        |        |        |
| 280 mm                    |  |        |        |        |
| 290 mm                    |  |        |        |        |
| 300 mm                    | 2  | 2      | 2      | 2      |
| 310 mm                    |  |        |        |        |
| 320 mm                    |  |        |        |        |
| 330 mm                    |  |        |        |        |
| 340 mm                    |  |        |        |        |

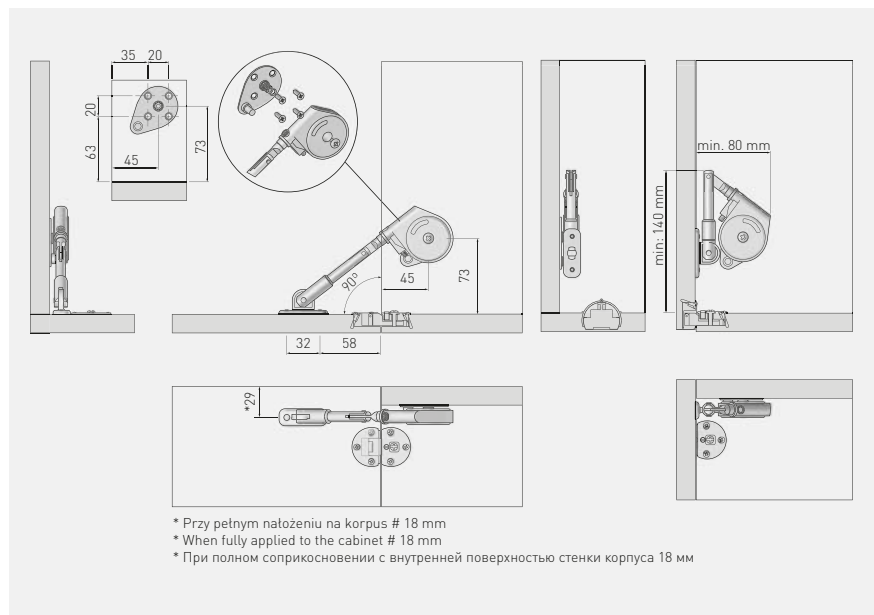

Amortyzator VIM do klap barkowych, długi  
 VIM stay lift for drop down cabinet doors, long  
 Амортизатор барный VIM, длинный



Produkt kompatybilny  
 z zawiasem barkowym: PD-MD-ZB  
 Compatible with flap hinge: PD-MD-ZB  
 Продукт совместим с барной петлей: PD-MD-ZB

|   |   |   |
|---|---|---|
|  |  |  |
| PD-MDLIFT-P2-D  | szary<br>gray<br>серый  | stal<br>steel<br>сталь  |



Orientacyjna tabela wartości doboru podnośników,  
 w zależności od szerokości i wysokości kłapy.  
 Maximum weight depending on the flap width and  
 height.

Таблица подбора амортизатора в зависимости от  
 ширины и высоты фасада.

| Wysokość<br>Height<br>Высота | Szerokość (mm) / Width (mm) /<br>Ширина (мм)                       |        |        |        |
|------------------------------|--|--------|--------|--------|
|                              | 600 mm   | 700 mm | 800 mm | 900 mm |
|                              | Ilość amortyzatorów<br>Number of lifts<br>Количество амортизаторов |        |        |        |
| 350 mm                       |  |        |        |        |
| 360 mm                       |  |        |        |        |
| 370 mm                       | 1  | 2      | 2      | 2      |
| 380 mm                       |  |        |        |        |
| 390 mm                       |  |        |        |        |
| 400 mm                       |  |        |        |        |

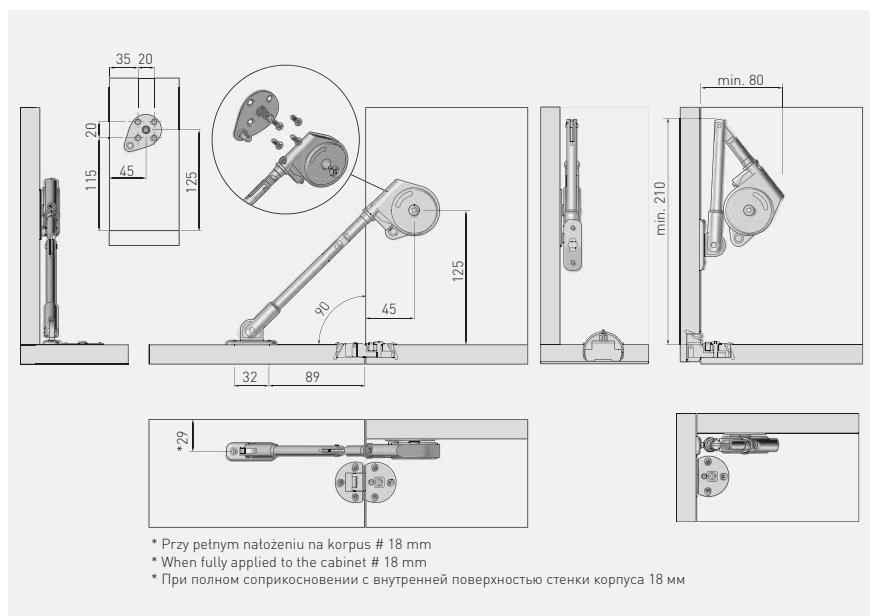

Amortyzator olejowy do klap barkowych  
Oil stay lift for drop down cabinet doors  
Амортизатор маслянный барный

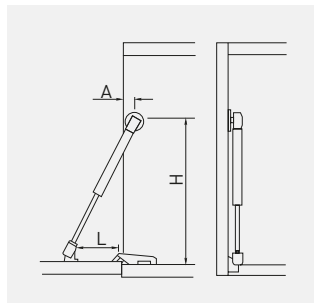

|              |       |                        |                        |
|--------------|-------|------------------------|------------------------|
|              |       |                        |                        |
| PD-ECGDL-060 | 60 N  | szary<br>gray<br>серый | stal<br>steel<br>сталь |
| PD-ECGDL-080 | 80 N  |                        |                        |
| PD-ECGDL-150 | 150 N |                        |                        |



| Kąt otwarcia drzwi<br>Door opening angle<br>Угол открывания дверей | Drzwi wpuszczane<br>Inset door<br>Внутренние дверцы |        |        | Drzwi bliźniacze<br>Twin door<br>Двойные дверцы |        |        | Drzwi nakładane<br>Overlay door<br>Наружные дверцы |        |        |
|--|---|--------|--------|---|--------|--------|--|--------|--------|
|  | H (mm)  | L (mm) | A (mm) | H (mm)  | L (mm) | A (mm) | H (mm)   | L (mm) | A (mm) |
| 90°  | 260   | 90     | 45     | 253   | 90     | 25     | 246  | 90     | 25     |

| Kąt otwarcia drzwi<br>Door opening angle<br>Угол открывания дверей | Siła podnośnika<br>Lift force<br>Мощность подъемника | Wysokość drzwi (mm) / Door height (mm) / Высота дверцы (мм) |     |     |     |
|--|--|---|-----|-----|-----|
|  |  | 300   | 400 | 500 | 600 |
|  |  | Waga drzwi (kg) / Door weight (kg) / Вес дверцы (кг)        |     |     |     |
| <br>90°  | 60 N   | 1,8   | 1,3 | 1,1 | 0,9 |
|  | 80 N   | 2,4   | 1,8 | 1,4 | 1,2 |
|  | 150 N  | 4,1   | 3,2 | 2,3 | 2,1 |

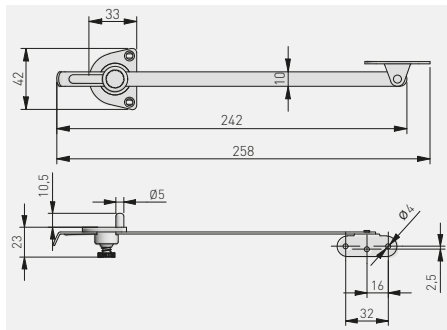

Rozwórka  
 Stay  
 Барный кронштейн

|                 | INFO   |                        |   |
|-----------------|--|------------------------|---|
| MR-SPG-UNI-GAL* | Rozwórka samohamująca uniwersalna galwanizowana<br>Universal self-locking galvanized stay<br>Барный кронштейн самоблокирующий универсальный оцинкованный | szary<br>gray<br>серый | stal, tworzywo<br>steel, plastic<br>сталь, пластмасса |
| MR-SPG-UNI-OC   | Rozwórka samohamująca uniwersalna cynkowa<br>Universal self-locking galvanized stay<br>Барный кронштейн самоблокирующий универсальный оцинкованный       |                        |   |



\*Produkt dostępny na indywidualne zamówienie / Available for special orders / Товар доступен под заказ

| Wysokość kłapy<br>Flap height<br>(mm)<br>Высота фасада<br>(мм) | Szerokość kłapy (mm)<br>Flap width (mm)<br>Ширина фасада (мм) |     |     |     |     |     |     |      |
|--|---|-----|-----|-----|-----|-----|-----|------|
|  | 300   | 400 | 500 | 600 | 700 | 800 | 900 | 1000 |
| 320  | 1,1   | 1,5 | 1,9 | 2,1 | 2,6 | 2,9 | 3,3 | 3,6  |
| 350  | 1,2   | 1,6 | 2,0 | 2,5 | 2,9 | 3,3 | 3,7 | 4,0  |
| 400  | 1,4   | 1,8 | 2,3 | 2,8 | 3,3 | 3,7 | 4,2 | 4,6  |
| 450  | 1,6   | 2,1 | 2,6 | 3,1 | 3,7 | 4,2 | 4,7 | 5,3  |
| 500  | 1,8   | 2,3 | 2,9 | 3,5 | 4,1 | 4,7 | 5,3 | 5,8  |
| 550  | 1,9   | 2,6 | 3,2 | 3,9 | 4,5 | 5,1 | 5,8 | 6,4  |
| 600  | 2,1   | 2,8 | 3,5 | 4,2 | 4,9 | 5,6 | 6,3 | 7,0  |

Ciężar kłapy w kg (płyta wiórowa: grubość = 18 mm, gęstość = 650 kg/m<sup>3</sup>)  
 Flap weight in kg (chipboard: thickness = 18 mm, density = 650 kg/m<sup>3</sup>)  
 Вес фасада в кг (ДСП: толщина = 18 мм, плотность = 650 кг / м<sup>3</sup>)

\*przy szerszych kłapkach - sugerowane 2 rozwórki  
 \*with wider flaps - suggested 2 stays

\*для более широких фасадов рекомендуется 2 барные кронштейна

Prowadnice dolnego montażu Modern Slide Pro  
 Undermount drawer slide Modern Slide Pro  
 Направляющая нижнего монтажа Modern Slide Pro







krawędź szafki / cabinet edge / край шкафа

1. prowadnica lewa/prawa  
drawer slide L/R  
направляющая Л/П
2. sprzęgło lewe/prawe + wkrety  
locking device L/R + screws  
крепления фасада Л/П + саморезы

NL = długość nominalna prowadnicy  
nominal slide length  
номинальная длина направляющей

AV = strata wyciwni  
extension loss  
потеря на выдвигении

Uwagi montażowe: dla prawidłowego działania szuflady jej szerokość nie może przekraczać długości nominalnej prowadnicy.  
 Mounting information: for proper drawer operation, the width of the drawer can not exceed the nominal slide length.  
 Техническое примечание: ширина ящика не должна превышать длину направляющей.

|  | $L$<br>mm | $AV$<br>mm |  |  |  |  |
|---|-----------|------------|---|---|---|---|
| PB-3D0SHX18-300-PRO   | 300       | 30         | pełny<br>full<br>полное   | 35  | ocynk<br>galvanized<br>гальваника   | stal<br>steel<br>сталь  |
| PB-3D0SHX18-350-PRO   | 350       | 30         |   |   |   |   |
| PB-3D0SHX18-400-PRO   | 400       | 30         |   |   |   |   |
| PB-3D0SHX18-450-PRO   | 450       | 30         |   |   |   |   |
| PB-3D0SHX18-500-PRO   | 500       | 30         |   |   |   |   |
| PB-3D0SHX18-550-PRO   | 550       | 30         |   |   |   |   |



Prowadnica dolnego montażu ze spowalniczem 0SHX-18 3D  
 Undermount drawer slide with soft closing 0SHX-18 3D  
 Направляющая нижнего монтажа с доводчиком 0SHX-18 3D









krawędź szafki / cabinet edge / край шкафа

1. prowadnica lewa/prawa  
drawer slide L/R  
направляющая Л/П
2. sprzęgło lewe/prawe + wkrety  
locking device L/R + screws  
крепления фасада Л/П + саморезы

NL = długość nominalna prowadnicy  
nominal slide length  
номинальная длина направляющей

AV = strata wysuwu  
extension loss  
потеря на выдвигении

Uwagi montażowe: dla prawidłowego działania szuflady jej szerokość nie może przekraczać długości nominalnej prowadnicy.  
 Mounting information: for proper drawer operation, the width of the drawer can not exceed the nominal slide length.  
 Техническое примечание: ширина ящика не должна превышать длину направляющей.

|  | <br>L<br>mm | <br>AV<br>mm | <br>kg |  |  |                        |
|---|--|---|---|---|---|------------------------|
| PB-3D0SHX18-250-H   | 250  | 16  | petny<br>full<br>полное   | 30  | ocynk<br>galvanized<br>гальваника   | stal<br>steel<br>сталь |
| PB-3D0SHX18-300-H   | 300  |   |   |   |   |                        |
| PB-3D0SHX18-350-H   | 350  |   |   |   |   |                        |
| PB-3D0SHX18-400-H   | 400  |   |   |   |   |                        |
| PB-3D0SHX18-450-H   | 450  |   |   |   |   |                        |
| PB-3D0SHX18-500-H   | 500  |   |   |   |   |                        |
| PB-3D0SHX18-550-H   | 550  |   |   |   |   |                        |
| PB-3D0SHX18-600-H   | 600  |   |   |   |   |                        |



Prowadnica dolnego montażu ze spowalniaczem OSHX

Undermount drawer slide with soft closing OSHX

Направляющая нижнего монтажа полного выдвижения с доводчиком OSHX



Rozstaw otworów montażowych  
Mounting dimensions  
Монтажные отверстия

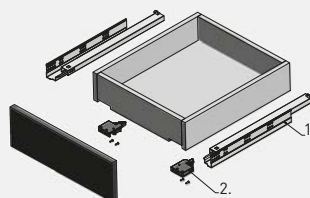
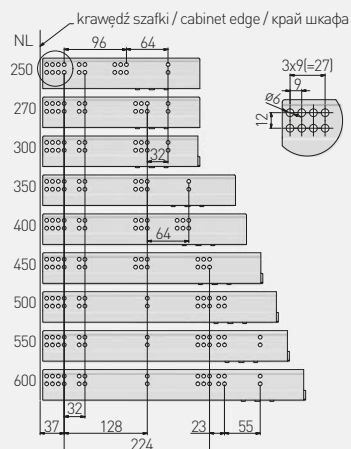

1. prowadnica lewa/prawa  
drawer slide L/R  
направляющая Л/П
2. sprzęgło lewe/prawe + wkręty  
locking device L/R + screws  
крепления фасада Л/П + саморезы

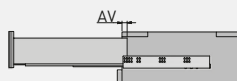

NL = długość nominalna prowadnicy  
nominal slide length  
номинальная длина направляющей

AV = strata wysuwu  
extension loss  
потеря на выдвигении

Uwagi montażowe: dla prawidłowego działania szuflady jej szerokość nie może przekraczać długości nominalnej prowadnicy.  
Mounting information: for proper drawer operation, the width of the drawer can not exceed the nominal slide length.  
Техническое примечание: ширина ящика не должна превышать длину направляющей.

|               | L<br>mm | AV<br>mm |                         | kg |                                   |                        |
|---------------|---------|----------|-------------------------|----|-----------------------------------|------------------------|
| PB-0SHX-250-A | 250     | 16       | pełny<br>full<br>полное | 35 | ocynk<br>galvanized<br>гальваника | stal<br>steel<br>сталь |
| PB-0SHX-270-A | 270     |          |                         |    |                                   |                        |
| PB-0SHX-300-A | 300     |          |                         |    |                                   |                        |
| PB-0SHX-350-A | 350     |          |                         |    |                                   |                        |
| PB-0SHX-400-A | 400     |          |                         |    |                                   |                        |
| PB-0SHX-450-A | 450     |          |                         |    |                                   |                        |
| PB-0SHX-500-A | 500     |          |                         |    |                                   |                        |
| PB-0SHX-550-A | 550     |          |                         |    |                                   |                        |
| PB-0SHX-600-A | 600     |          |                         |    |                                   |                        |







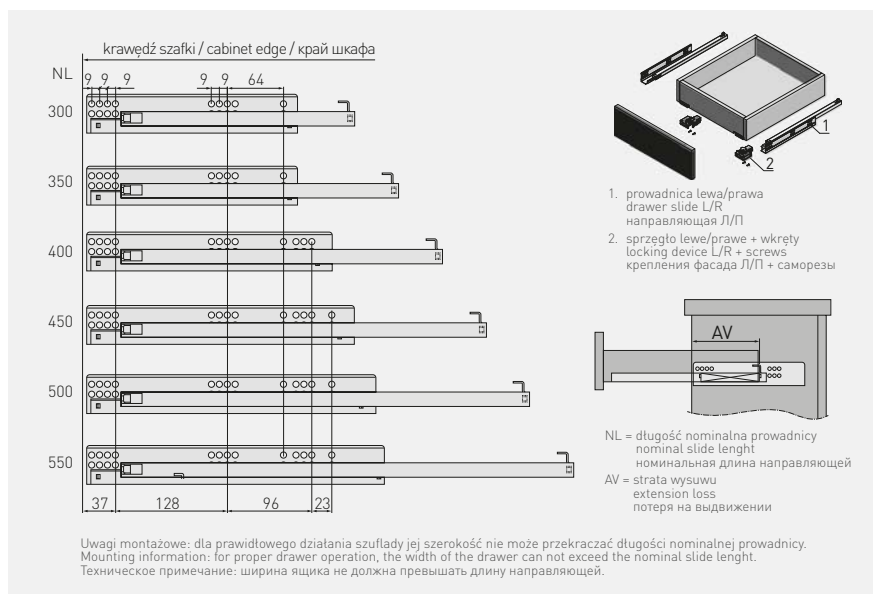

Prowadnica dolnego montażu ze spowalniczem GCHX18-H

Undermount drawer slide with soft closing GCHX18-H

Направляющая нижнего монтажа неполное выдвигание с доводчиком GCHX18-H



|                 |  |  L<br>mm |  AV<br>mm |  |  |  |                        |
|-----------------|---|---|--|---|---|---|------------------------|
| PB-GCHX18-300-H |   | 300   | 88,5 mm  | niepełny<br>partial<br>неполное   | 25 kg   | ocynk<br>galvanized<br>гальваника   | stal<br>steel<br>сталь |
| PB-GCHX18-350-H |   | 350   |  |   |   |   |                        |
| PB-GCHX18-400-H |   | 400   |  |   |   |   |                        |
| PB-GCHX18-450-H |   | 450   |  |   |   |   |                        |
| PB-GCHX18-500-H |   | 500   |  |   |   |   |                        |
| PB-GCHX18-550-H |   | 550   |  |   |   |   |                        |





Wspornik szuflad cokotowych MORE SPACE  
 Plinth drawer support MORE SPACE  
 Опора плинтусного ящика MORE SPACE



PB-WSPCOK

ocynk / galvanized / гальваника

stal / steel / сталь

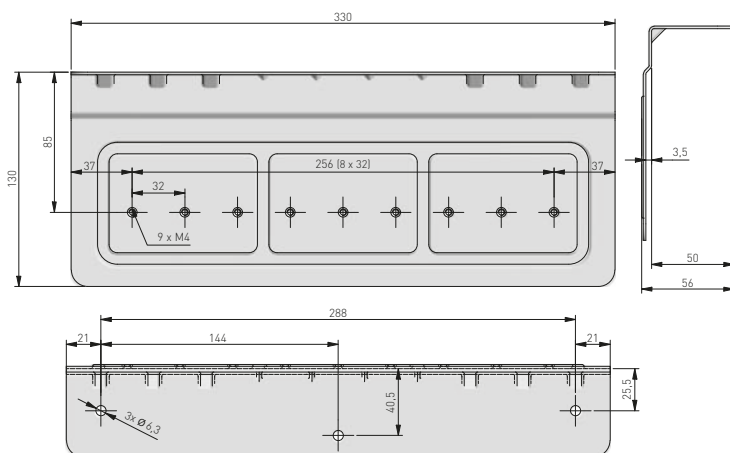

Prowadnica dolnego montażu push to open 0FPO18  
 Undermount drawer slide push to open 0FPO18  
 Направляющая нижнего монтажа push to open 0FPO18



Możliwość zastosowania stabilizatora PB-D-P20STAB  
 Can be used with stabilizer PB-D-P20STAB  
 Возможность использования стабилизатора стабилизатора PB-D-P20STAB

krawędź szafki / cabinet edge / край шкафа

NL = długość nominalna prowadnicy  
 nominal slide length  
 номинальная длина направляющей

AV = strata wysuwu  
 extension loss  
 потеря на выдвигении

Uwagi montażowe: dla prawidłowego działania szuflady jej szerokość nie może przekraczać długości nominalnej prowadnicy.  
 Mounting information: for proper drawer operation, the width of the drawer can not exceed the nominal slide length.  
 Техническое примечание: ширина ящика не должна превышать длину направляющей.

|               | L<br>mm | AV<br>mm |                         | kg |                                   |                        |
|---------------|---------|----------|-------------------------|----|-----------------------------------|------------------------|
| PB-0FPO18-250 | 250     | 26       | pełny<br>full<br>полное | 25 | ocynk<br>galvanized<br>гальваника | stal<br>steel<br>сталь |
| PB-0FPO18-300 | 300     |          |                         |    |                                   |                        |
| PB-0FPO18-350 | 350     |          |                         |    |                                   |                        |
| PB-0FPO18-400 | 400     |          |                         |    |                                   |                        |
| PB-0FPO18-450 | 450     |          |                         |    |                                   |                        |
| PB-0FPO18-500 | 500     |          |                         |    |                                   |                        |
| PB-0FPO18-550 | 550     |          |                         |    |                                   |                        |
| PB-0FPO18-600 | 600     |          |                         |    |                                   |                        |





Prowadnice dolnego montażu ze spowalniczem G10HX-H

Undermount drawer slide with soft closing G10HX-H

Направляющая нижнего монтажа неполное выдвижение с доводчиком G10HX-H





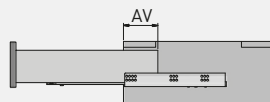
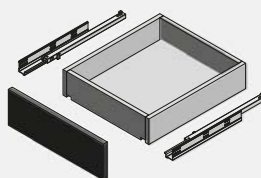
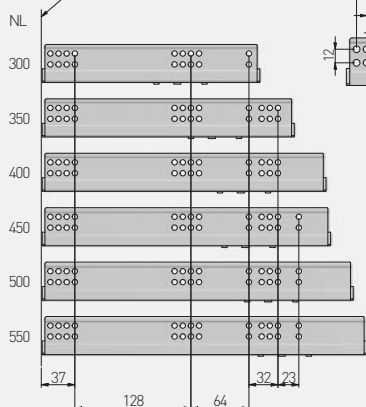



krawędź szafki / cabinet edge / край шкафа



NL = długość nominalna prowadnicy  
nominal slide length  
номинальная длина направляющей  
AV = strata wysuwu  
extension loss  
потеря на выдвижении





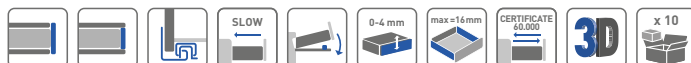



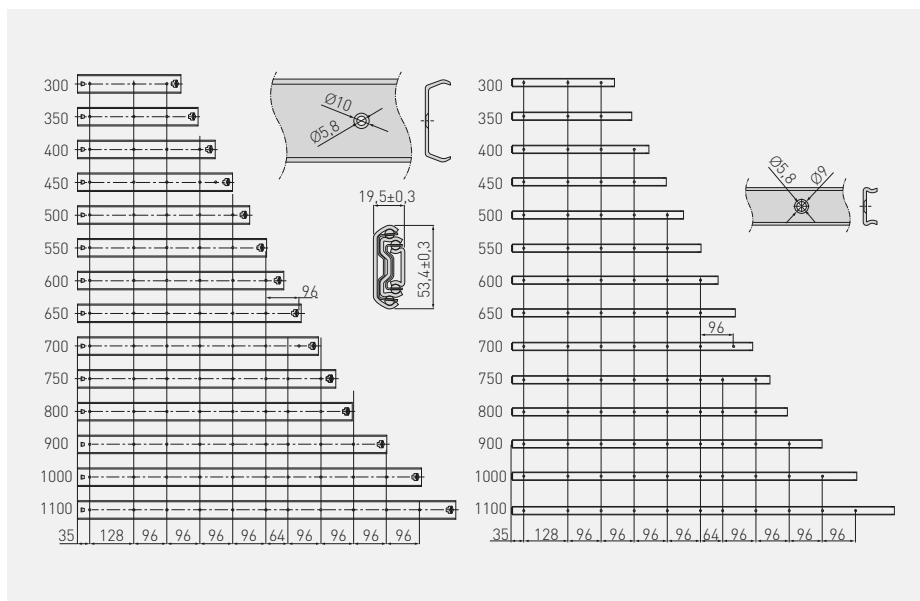







Uwagi montażowe: dla prawidłowego działania szuflady jej szerokość nie może przekraczać długości nominalnej prowadnicy.  
Mounting information: for proper drawer operation, the width of the drawer can not exceed the nominal slide length.  
Техническое примечание: ширина ящика не должна превышать длину направляющей.

|  |  L<br>mm |  AV<br>mm |                                     |  |  |                        |
|---|---|--|--|---|---|------------------------|
| PB-G10HX300-H   | 300   | 83   | <br>niepełny<br>partial<br>неполное | 25  | ocynk<br>galvanized<br>гальваника   | stal<br>steel<br>сталь |
| PB-G10HX350-H   | 350   |  |  |   |   |                        |
| PB-G10HX450-H   | 450   |  |  |   |   |                        |
| PB-G10HX500-H   | 500   |  |  |   |   |                        |
| PB-G10HX550-H   | 550   |  |  |   |   |                        |



Prowadnica kulkowa H53  
 Ball bearing slide H53  
 Шариковая направляющая H53









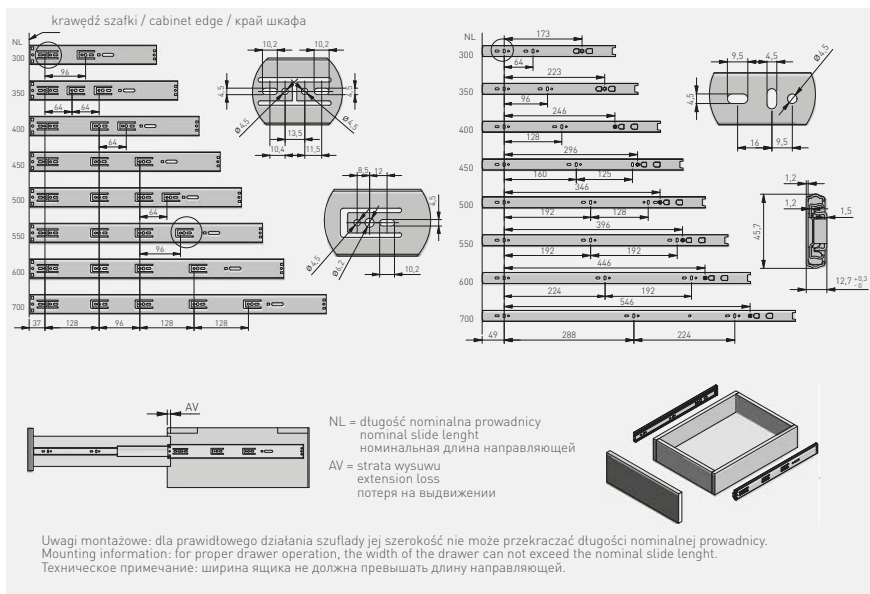

|              |  |  L<br>mm |  AV<br>mm |  kg |  |  |                         |  |  L<br>mm |  AV<br>mm |  kg |  |  |   |     |   |   |
|--------------|---|---|--|--|---|---|-------------------------|---|---|--|--|---|---|---|-----|---|---|
| PK-0-H53-300 |   | 300   | -  | 100  |  |  | petny<br>full<br>полное | 100   | ocynk<br>galvanized<br>гальваника   | stat<br>steel<br>сталь   | PK-0-H53-650   |   | 650   | - | 100 |  |  |
| PK-0-H53-350 |   | 350   | -  |  |   |   |                         |   |   |  | PK-0-H53-700   |   | 700   | - |     |   |   |
| PK-0-H53-400 |   | 400   | -  |  |   |   |                         |   |   |  | PK-0-H53-750   |   | 750   | - |     |   |   |
| PK-0-H53-450 |   | 450   | -  |  |   |   |                         |   |   |  | PK-0-H53-800   |   | 800   | - |     |   |   |
| PK-0-H53-500 |   | 500   | -  |  |   |   |                         |   |   |  | PK-0-H53-900   |   | 900   | - |     |   |   |
| PK-0-H53-550 |   | 550   | -  |  |   |   |                         |   |   |  | PK-0-H53-1000  |   | 1000  | - |     |   |   |
| PK-0-H53-600 |   | 600   | -  |  |   |   |                         |   |   |  | PK-0-H53-1100  |   | 1100  | - |     |   |   |





Prowadnica kulkowa VERSALITE PRO H45 push to open i soft close  
 Ball bearing slide VERSALITE PRO H45 push to open & soft close  
 Шариковая направляющая VERSALITE PRO H45 push to open с soft close



|                  |  |  |  |  |  |  |  |
|------------------|---|---|---|---|---|---|---|
| PK-L-P20-H45-300 |   | 300   | 52  | pełny<br>full<br>полное   | 30  | ocynk<br>galvanized<br>гальваника   | stal<br>steel<br>сталь  |
| PK-L-P20-H45-350 |   | 350   | 35  |   |   |   |   |
| PK-L-P20-H45-400 |   | 400   | 20  |   |   |   |   |
| PK-L-P20-H45-450 |   | 450   | 4   |   |   |   |   |
| PK-L-P20-H45-500 |   | 500   |   |   |   |   |   |
| PK-L-P20-H45-550 |   | 550   |   |   |   |   |   |
| PK-L-P20-H45-600 |   | 600   |   |   |   |   |   |
| PK-L-P20-H45-700 |   | 700   |   |   |   |   |   |









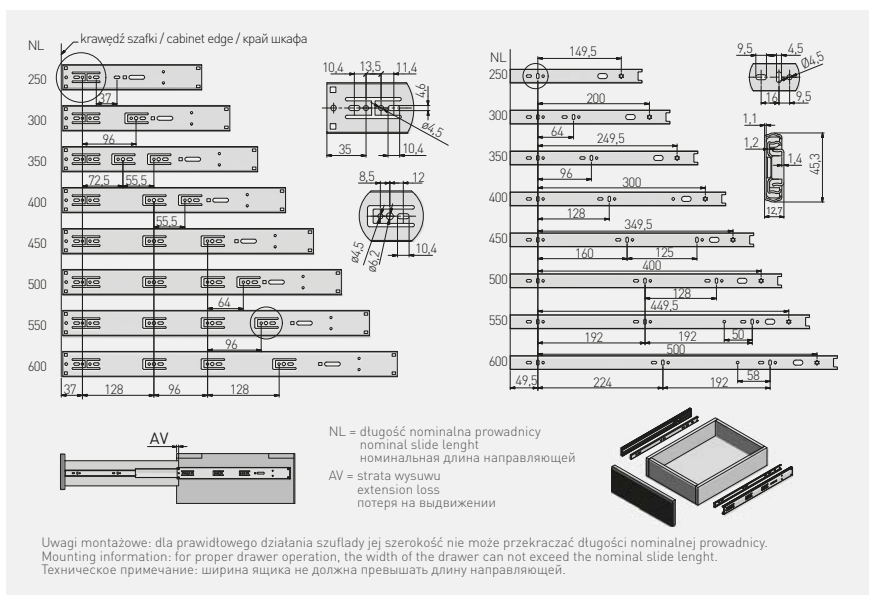

ICE CREAM

Prowadnica kulkowa VERSALITE PLUS ze spowalniczem H45  
 Ball bearing slide VERSALITE PLUS with soft closing H45  
 Шариковая направляющая VERSALITE PLUS с доводчиком H45



|              |  |  L<br>mm |  AV<br>mm |  |  kg |  |  |
|--------------|---|---|--|---|--|---|---|
| PK-L-H45-250 |   | 250*  | 102  | pełny<br>full<br>полное   | 30   | ocynk<br>galvanized<br>гальваника   | stal<br>steel<br>сталь  |
| PK-L-H45-300 |   | 300*  | 52   |   |  |   |   |
| PK-L-H45-350 |   | 350*  | 35   |   |  |   |   |
| PK-L-H45-400 |   | 400*  | 20   |   |  |   |   |
| PK-L-H45-450 |   | 450   | 4  |   |  |   |   |
| PK-L-H45-500 |   | 500   |  |   |  |   |   |
| PK-L-H45-550 |   | 550   |  |   |  |   |   |
| PK-L-H45-600 |   | 600   |  |   |  |   |   |

\* Brak pełnego wysuwu / Not full extension / Неполное выдвигение







Prowadnica kulkowa VERSALITE ze spowalniaczem H45\*  
 Ball bearing slide VERSALITE with soft closing H45\*  
 Шариковая направляющая VERSALITE с доводчиком H45\*

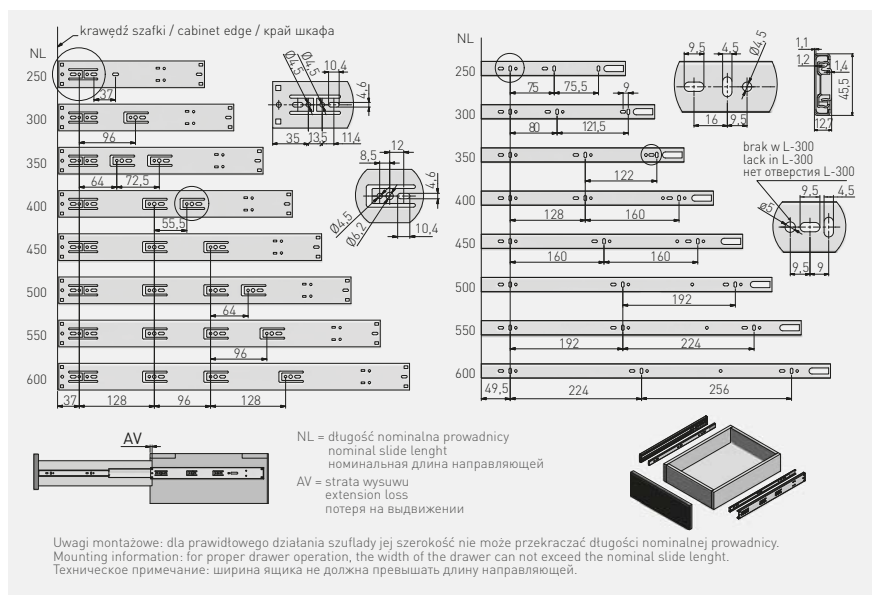

|                | L<br>mm | AV<br>mm |                         | kg |                                   |                        |
|----------------|---------|----------|-------------------------|----|-----------------------------------|------------------------|
| PK-L-H45-250-A | 250**   | 55       | pełny<br>full<br>полное | 30 | ocynk<br>galvanized<br>гальваника | stal<br>steel<br>сталь |
| PK-L-H45-300-A | 300     | 15       |                         |    |                                   |                        |
| PK-L-H45-350-A | 350     |          |                         |    |                                   |                        |
| PK-L-H45-400-A | 400     | 5        |                         |    |                                   |                        |
| PK-L-H45-450-A | 450     |          |                         |    |                                   |                        |
| PK-L-H45-500-A | 500     |          |                         |    |                                   |                        |
| PK-L-H45-550-A | 550     | 0        |                         |    |                                   |                        |
| PK-L-H45-600-A | 600     |          |                         |    |                                   |                        |

\*Produkt dostępny na indywidualne zamówienie / Available for special orders / Товар доступен под заказ







\*\* Brak pełnego wysuwu / Not full extension / Неполное выдвигание

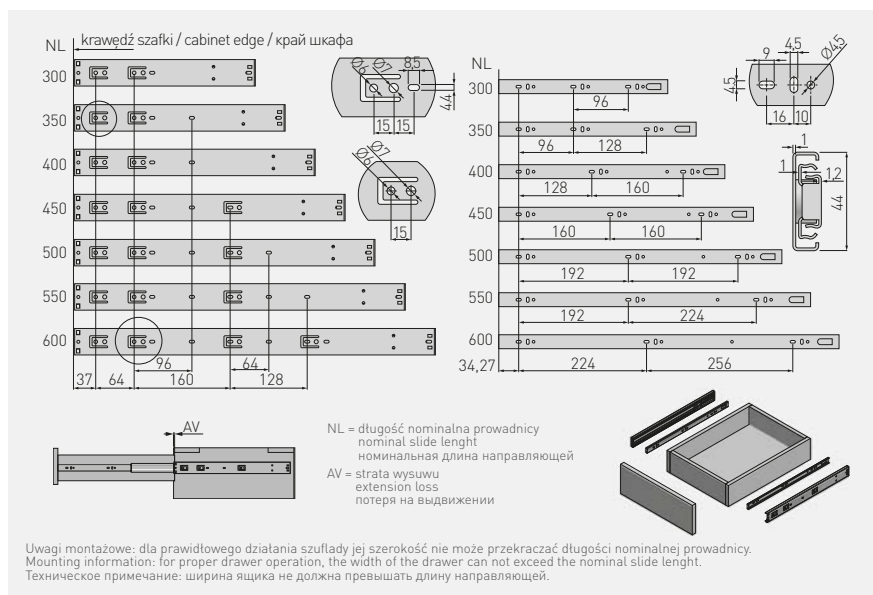



Prowadnica kulkowa VERSALITE LIGHT ze spawalniczem H45  
 Ball bearing slide VERSALITE LIGHT with soft closing H45  
 Шариковая направляющая VERSALITE LIGHT с доводчиком H45









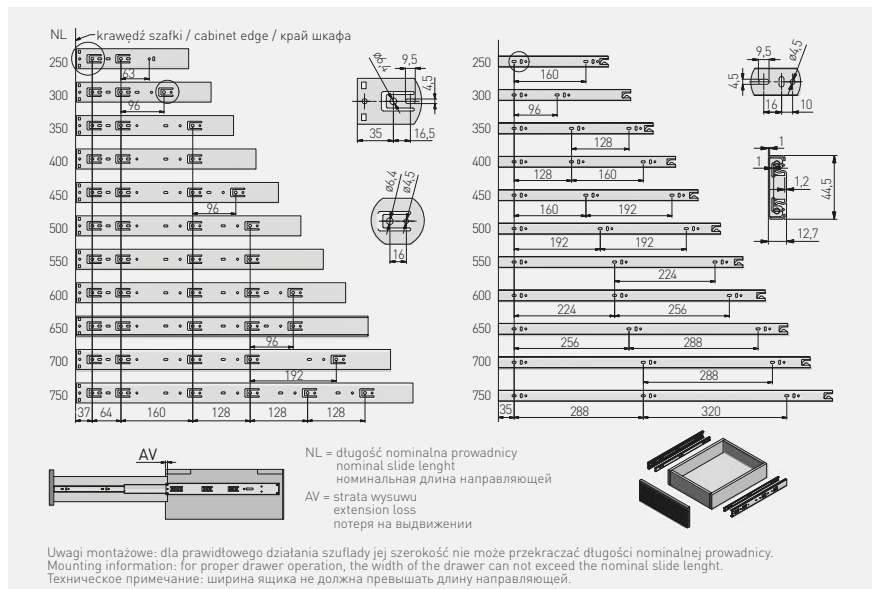

|                 |  |  L<br>mm |  AV<br>mm |  |  kg |  |  |
|-----------------|---|---|--|---|--|---|---|
| PK-L-H45-300-GX |   | 300*  | 50   | petny<br>full<br>полное   | 25   | ocynk<br>galvanized<br>гальваника   | stal<br>steel<br>сталь  |
| PK-L-H45-350-GX |   | 350   | 20   |   |  |   |   |
| PK-L-H45-400-GX |   | 400   |  |   |  |   |   |
| PK-L-H45-450-GX |   | 450   |  |   |  |   |   |
| PK-L-H45-500-GX |   | 500   |  |   |  |   |   |
| PK-L-H45-550-GX |   | 550   |  |   |  |   |   |
| PK-L-H45-600-GX |   | 600   |  |   |  |   |   |

\* Brak pełnego wysuwu / Not full extension / Неполное выдвигение



Prowadnica kulkowa z samodociąganiem H45  
 Ball bearing slide with self closing H45  
 Шариковая направляющая с фиксатором H45



|              |  |  L<br>mm |  AV<br>mm |  |  kg |  |  |  |
|--------------|---|---|--|---|--|---|---|---|
| PK-S-H45-250 |   | 250   | 22   | pełny<br>full<br>полное   | 35   | ocynk<br>galvanized<br>гальваника   | stal<br>steel<br>сталь  | 15  |
| PK-S-H45-300 |   | 300   |  |   |  |   |   |   |
| PK-S-H45-350 |   | 350   |  |   |  |   |   |   |
| PK-S-H45-400 |   | 400   |  |   |  |   |   |   |
| PK-S-H45-450 |   | 450   |  |   |  |   |   |   |
| PK-S-H45-500 |   | 500   |  |   |  |   |   |   |
| PK-S-H45-550 |   | 550   |  |   |  |   |   |   |
| PK-S-H45-600 |   | 600   |  | 10  |  |   |   |   |
| PK-S-H45-650 |   | 650   |  |   |  |   |   |   |
| PK-S-H45-700 |   | 700   |  |   |  |   |   |   |



Prowadnica kulkowa H45 PRESTIGE  
 Ball bearing slide H45 PRESTIGE  
 Шариковая направляющая H45 PRESTIGE

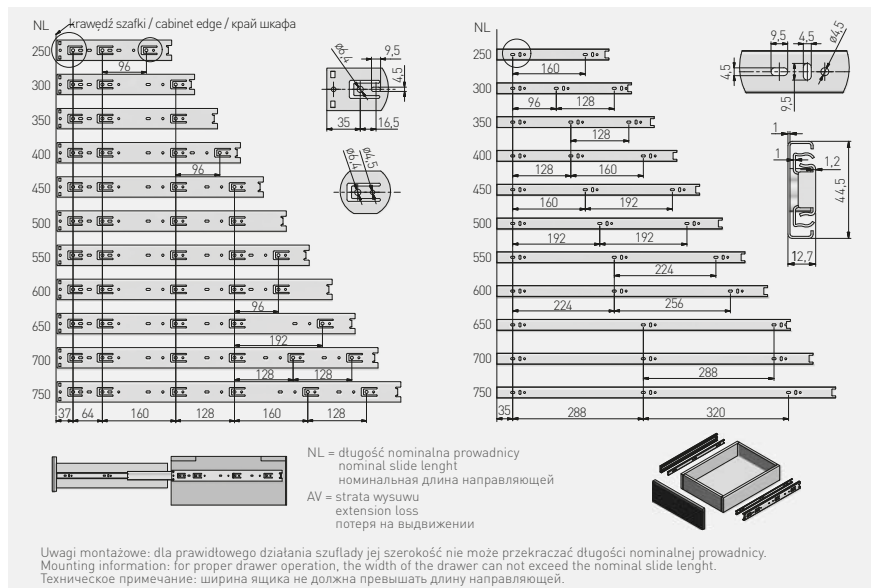

|              | $L$<br>mm | $AV$<br>mm |                         | $kg$<br>1 |                                   |                        |    |
|--------------|-----------|------------|-------------------------|-----------|-----------------------------------|------------------------|----|
| PK-0-H45-250 | 250       | -          | pełny<br>full<br>полное | 35        | ocynk<br>galvanized<br>гальваника | stal<br>steel<br>сталь | 15 |
| PK-0-H45-300 | 300       |            |                         |           |                                   |                        |    |
| PK-0-H45-350 | 350       |            |                         |           |                                   |                        |    |
| PK-0-H45-400 | 400       |            |                         |           |                                   |                        |    |
| PK-0-H45-450 | 450       |            |                         |           |                                   |                        |    |
| PK-0-H45-500 | 500       |            |                         |           |                                   |                        |    |
| PK-0-H45-550 | 550       |            |                         |           |                                   |                        |    |
| PK-0-H45-600 | 600       |            |                         |           |                                   |                        | 10 |
| PK-0-H45-650 | 650       |            |                         |           |                                   |                        |    |
| PK-0-H45-700 | 700       |            |                         |           |                                   |                        |    |



Prowadnica kulkowa H45 PRO  
 Ball bearing slide H45 PRO  
 Шариковая направляющая H45 PRO

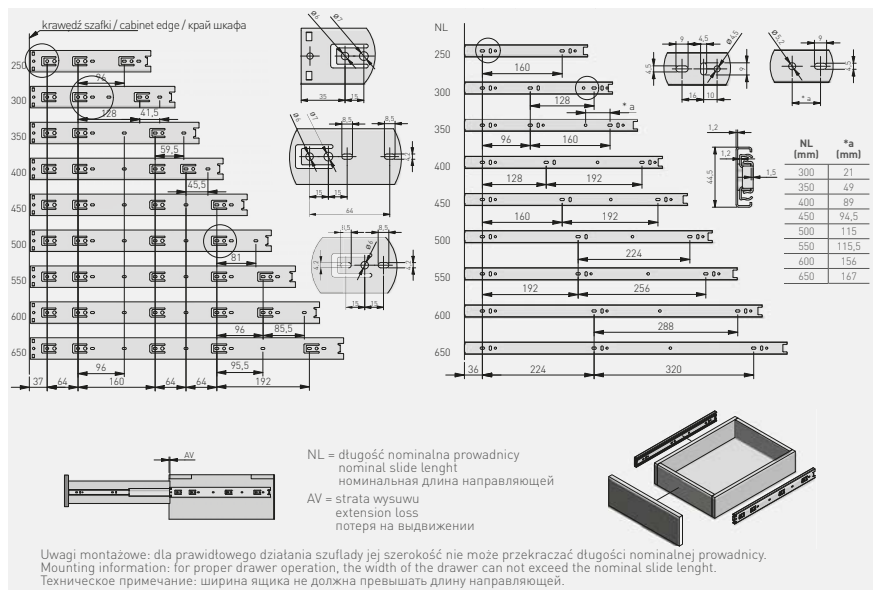

|                | L<br>mm | AV<br>mm |                         | kg |  |                        |    |
|----------------|---------|----------|-------------------------|----|--|------------------------|----|
| PK-PRO-H45-250 | 250     | 5        | pełny<br>full<br>полное | 50 |  | stal<br>steel<br>сталь | 15 |
| PK-PRO-H45-300 | 300     |          |                         |    |  |                        |    |
| PK-PRO-H45-350 | 350     |          |                         |    |  |                        |    |
| PK-PRO-H45-400 | 400     |          |                         |    |  |                        |    |
| PK-PRO-H45-450 | 450     |          |                         |    |  |                        |    |
| PK-PRO-H45-500 | 500     |          |                         |    |  |                        |    |
| PK-PRO-H45-550 | 550     |          |                         |    |  |                        |    |
| PK-PRO-H45-600 | 600     |          |                         |    |  |                        |    |
| PK-PRO-H45-650 | 650     |          |                         |    |  |                        |    |





Prowadnica kulkowa push to open H45 GX  
 Ball bearing slide push to open H45 GX  
 Шариковая направляющая push to open H45 GX







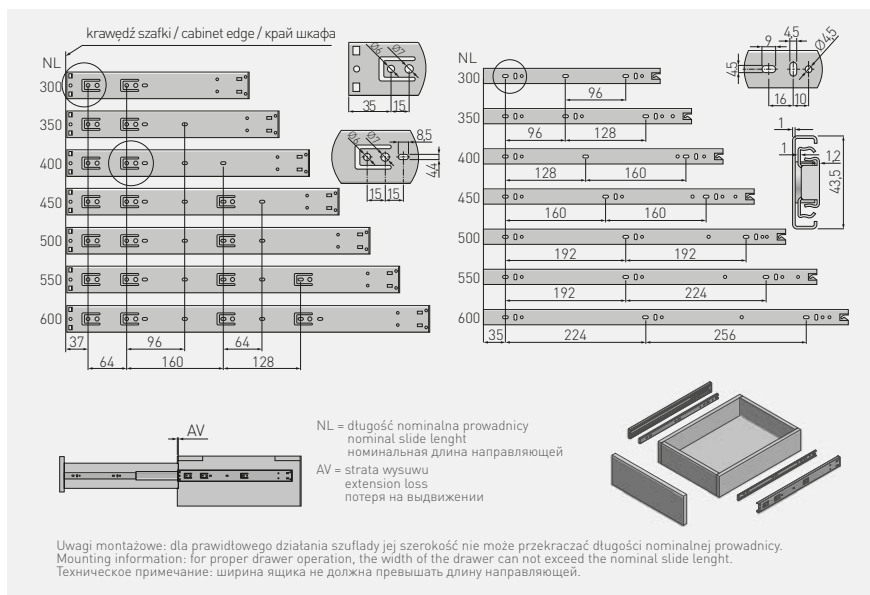

Możliwość zastosowania stabilizatora PB-D-P20STAB

Can be used with stabilizer PB-D-P20STAB

Возможность использования стабилизатора PB-D-P20STAB









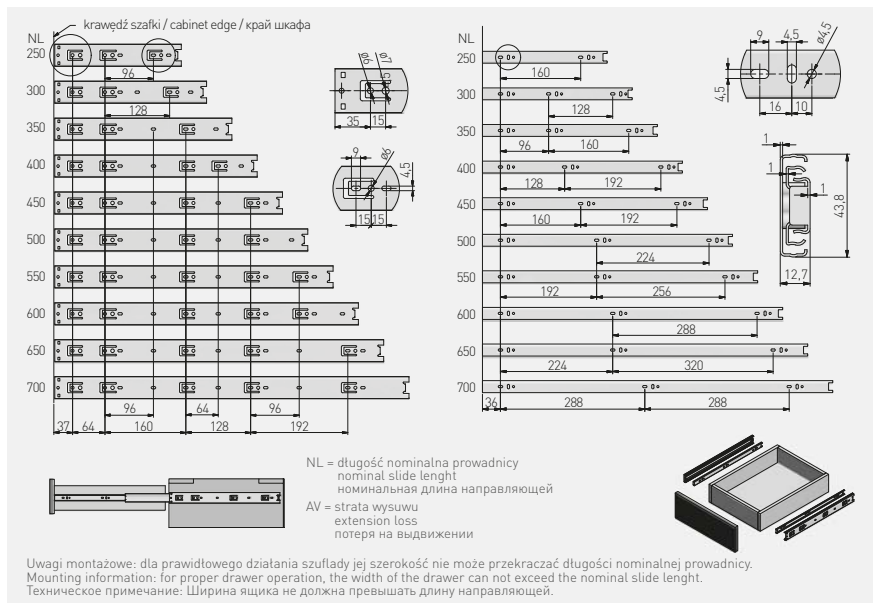

|                 |  |  L<br>mm |  AV<br>mm |  |  kg |  |  |
|-----------------|---|---|--|---|--|---|---|
| PK-P-H45-300-GX |   | 300*  | 30   | pełny<br>full<br>полное   | 25   | ocynk<br>galvanized<br>гальваника   | stal<br>steel<br>сталь  |
| PK-P-H45-350-GX |   | 350   |  |   |  |   |   |
| PK-P-H45-400-GX |   | 400   |  |   |  |   |   |
| PK-P-H45-450-GX |   | 450   |  |   |  |   |   |
| PK-P-H45-500-GX |   | 500   |  |   |  |   |   |
| PK-P-H45-550-GX |   | 550   |  |   |  |   |   |
| PK-P-H45-600-GX |   | 600   |  |   |  |   |   |

\* Brak pełnego wysuwu / Not full extension / Неполное выдвижение



Prowadnica kulkowa H45 GX1  
 Ball bearing slide H45 GX1  
 Шариковая направляющая H45 GX1



|               |  |  L<br>mm |  AV<br>mm |  |  kg |  |  |
|---------------|---|---|--|---|--|---|---|
| PK-0H45250GX1 |   | 250   | 5  | pełny<br>full<br>полное   | 30   | ocynk<br>galvanized<br>гальваника   | stal<br>steel<br>сталь  |
| PK-0H45300GX1 |   | 300   |  |   |  |   |   |
| PK-0H45350GX1 |   | 350   |  |   |  |   |   |
| PK-0H45400GX1 |   | 400   |  |   |  |   |   |
| PK-0H45450GX1 |   | 450   |  |   |  |   |   |
| PK-0H45500GX1 |   | 500   | -  |   |  |   |   |
| PK-0H45550GX1 |   | 550   |  |   |  |   |   |
| PK-0H45600GX1 |   | 600   |  |   |  |   |   |
| PK-0H45650GX1 |   | 650   |  |   |  |   |   |
| PK-0H45700GX1 |   | 700   |  |   |  |   |   |



Prowadnica kulkowa H45 HK  
Ball bearing slide H45 HK  
Шариковая направляющая H45 HK

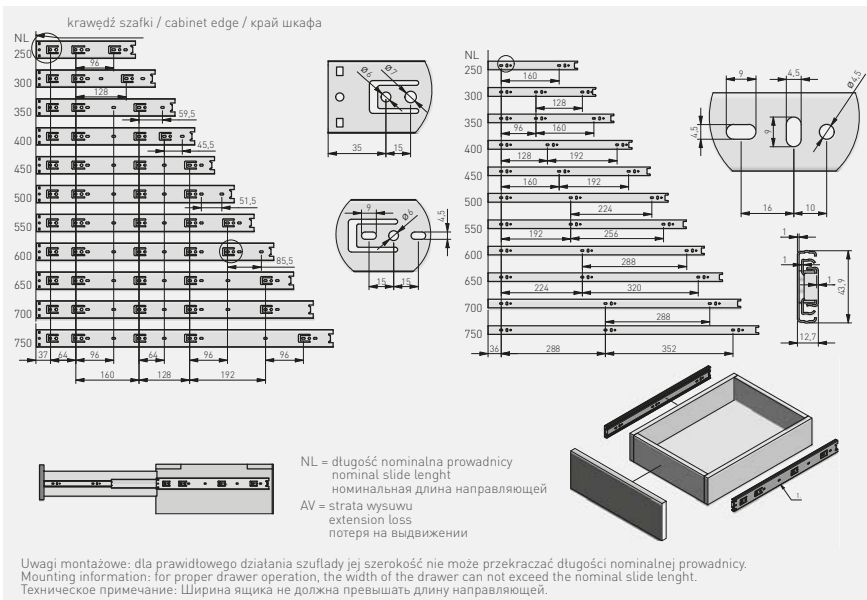

|              | L<br>mm | AV<br>mm | 30                      |    |                                   |
|--------------|---------|----------|-------------------------|----|-----------------------------------|
| PK-0H45250HK | 250     | 5        | petny<br>full<br>полное | 30 | ocynk<br>galvanized<br>гальваника |
| PK-0H45300HK | 300     | -        |                         |    |                                   |
| PK-0H45350HK | 350     |          |                         |    |                                   |
| PK-0H45400HK | 400     |          |                         |    |                                   |
| PK-0H45450HK | 450     |          |                         |    |                                   |
| PK-0H45500HK | 500     |          |                         |    |                                   |
| PK-0H45550HK | 550     |          |                         |    |                                   |
| PK-0H45600HK | 600     |          |                         |    |                                   |
| PK-0H45650HK | 650     |          |                         |    |                                   |
| PK-0H45700HK | 700     |          |                         |    |                                   |
| PK-0H45750HK | 750     |          |                         |    |                                   |









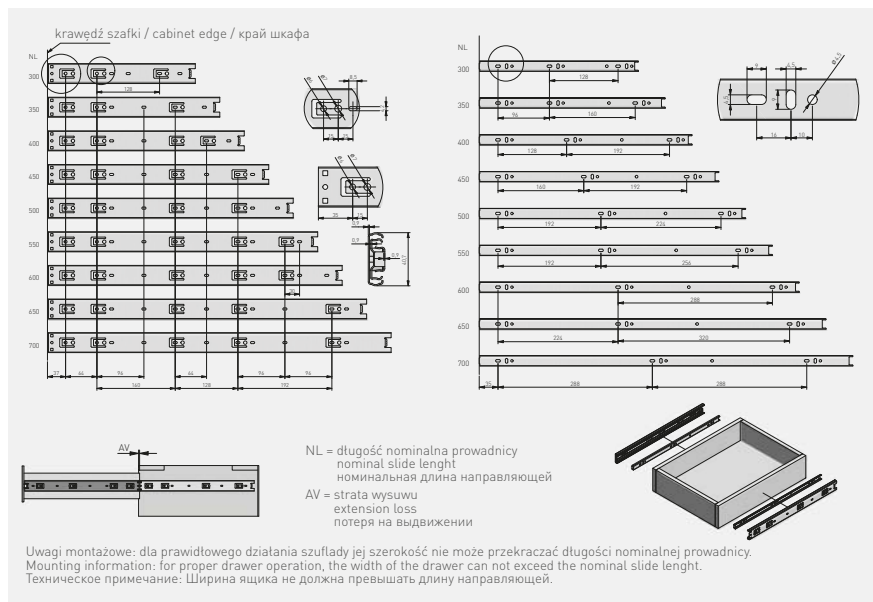



Prowadnica kulkowa H45 GX2-A  
 Ball bearing slide H45 GX2-A  
 Шариковая направляющая H45 GX2-A



|                 |  |  L<br>mm |  AV<br>mm |  |  Kg |  |  |
|-----------------|---|---|--|---|--|---|---|
| PK-0H45300GX2-A |   | 300   |  |   |  |   |   |
| PK-0H45350GX2-A |   | 350   |  |   |  |   |   |
| PK-0H45400GX2-A |   | 400   |  |   |  |   |   |
| PK-0H45450GX2-A |   | 450   |  |   |  |   |   |
| PK-0H45500GX2-A |   | 500   | -  | pełny<br>full<br>полное   | 25   | ocynk<br>galvanized<br>гальваника   | stal<br>steel<br>сталь  |
| PK-0H45550GX2-A |   | 550   |  |   |  |   |   |
| PK-0H45600GX2-A |   | 600   |  |   |  |   |   |
| PK-0H45650GX2-A |   | 650   |  |   |  |   |   |
| PK-0H45700GX2-A |   | 700   |  |   |  |   |   |





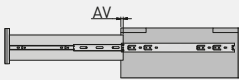
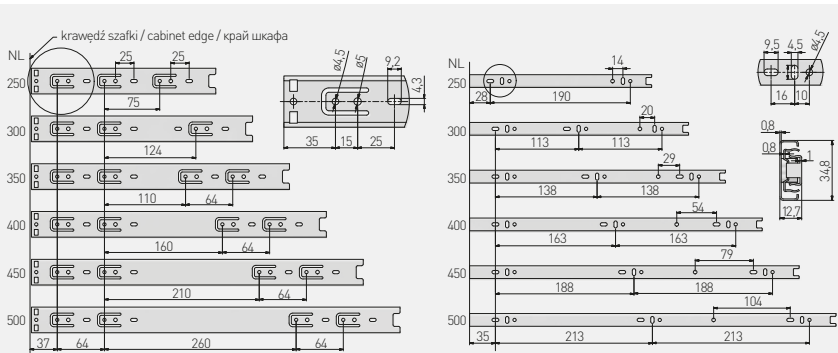





Prowadnica kulkowa H35  
Ball bearing slide H35  
Шариковая направляющая H35



NL = długość nominalna prowadnicy  
nominal slide length  
номинальная длина направляющей  
AV = strata wysunięciu  
extension loss  
потеря на выдвигении









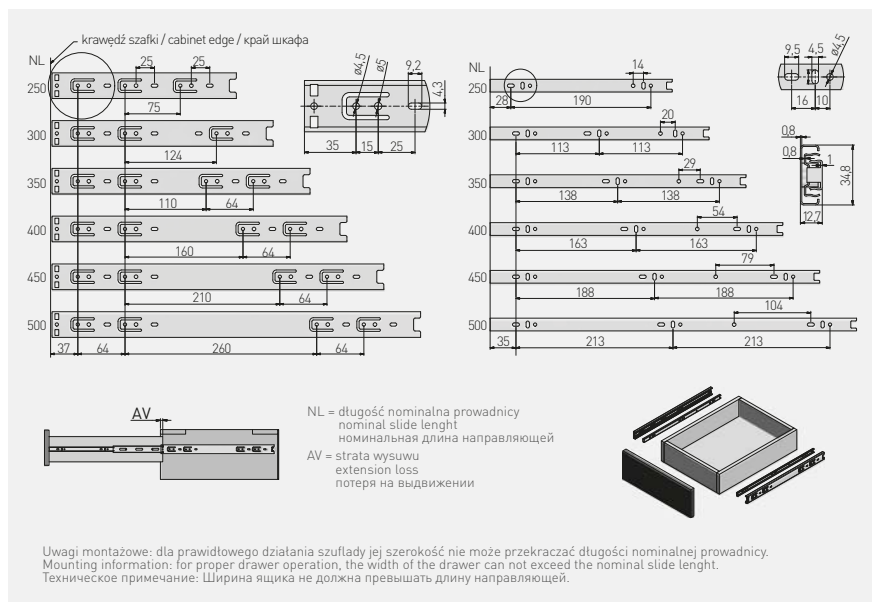

Uwagi montażowe: dla prawidłowego działania szuflady jej szerokość nie może przekraczać długości nominalnej prowadnicy.  
Mounting information: for proper drawer operation, the width of the drawer can not exceed the nominal slide length.  
Техническое примечание: Ширина ящика не должна превышать длину направляющей.

|  | <br>L<br>mm | <br>AV<br>mm |  | <br>kg |  |  |  |
|---|--|---|---|---|---|---|---|
| PK-0-H35-2500   | 250  | 4   | pełny<br>full<br>полное   | 20  | ocynk<br>galvanized<br>гальваника   | stal<br>steel<br>сталь  | 20  |
| PK-0-H35-3000   | 300  |   |   |   |   |   |   |
| PK-0-H35-3500   | 350  |   |   |   |   |   |   |
| PK-0-H35-4000   | 400  |   |   |   |   |   |   |
| PK-0-H35-4500   | 450  |   |   |   |   |   |   |
| PK-0-H35-5000   | 500  |   |   |   |   |   |   |



Prowadnica kulkowa H35  
Ball bearing slide H35  
Шариковая направляющая H35







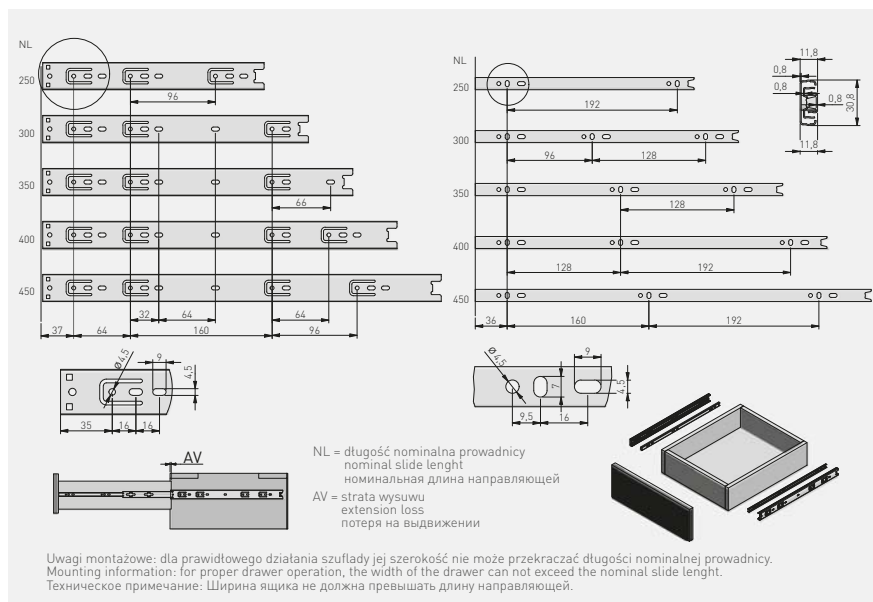

|                |  |  L<br>mm |  AV<br>mm |  |  kg |  |  |  |
|----------------|---|---|--|---|--|---|---|---|
| PK-0-H35-2500L |   | 250   | 4  | pełny<br>full<br>полное   | 20   | ocynk<br>galvanized<br>гальваника   | stal<br>steel<br>сталь  | 30  |
| PK-0-H35-3000L |   | 300   |  |   |  |   |   | 20  |
| PK-0-H35-3500L |   | 350   |  |   |  |   |   | 20  |
| PK-0-H35-4000L |   | 400   |  |   |  |   |   | 20  |
| PK-0-H35-4500L |   | 450   |  |   |  |   |   | 20  |
| PK-0-H35-5000L |   | 500   |  |   |  |   |   | 20  |



Prowadnica kulkowa H30  
Ball bearing slide H30  
Шариковая направляющая H30







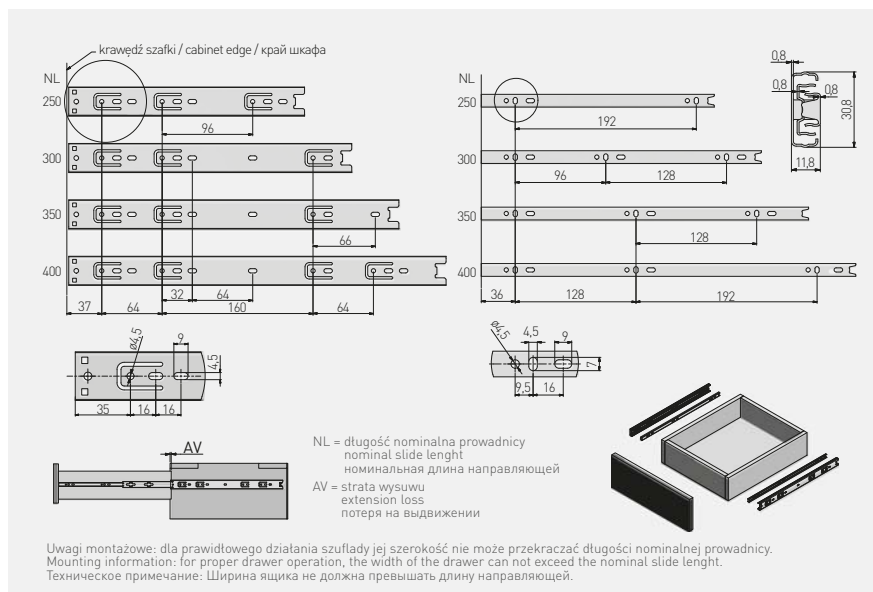

|              |  |  L<br>mm |  AV<br>mm |  |  kg |  |  |
|--------------|---|---|--|---|--|---|---|
| PK-0H30-2500 |   | 250   | -  | pełny<br>full<br>полное   | 15   | ocynk<br>galvanized<br>гальваника   | stal<br>steel<br>сталь  |
| PK-0H30-3000 |   | 300   |  |   |  |   |   |
| PK-0H30-3500 |   | 350   |  |   |  |   |   |
| PK-0H30-4000 |   | 400   |  |   |  |   |   |
| PK-0H30-4500 |   | 450   |  |   |  |   |   |



Prowadnica kulkowa H30  
Ball bearing slide H30  
Шариковая направляющая H30







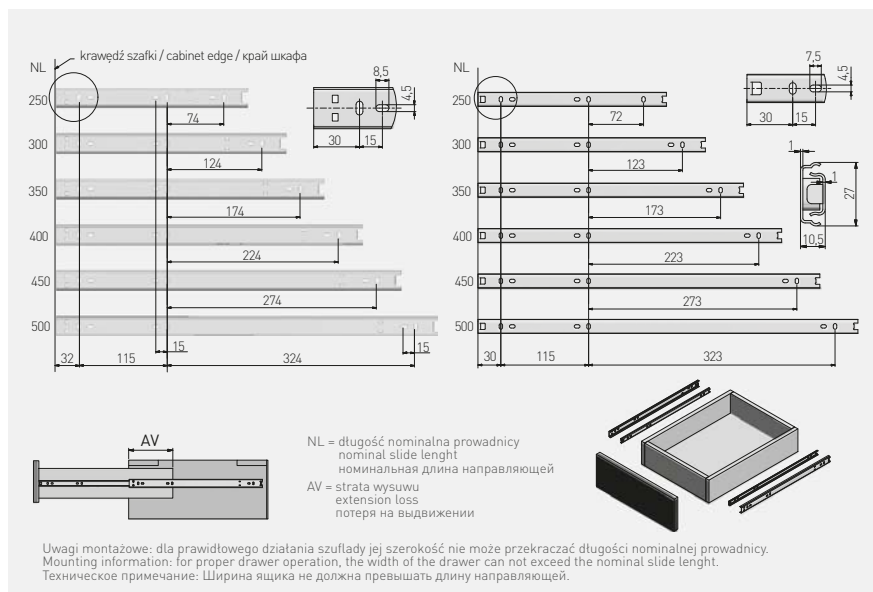

|                |  |  L<br>mm |  AV<br>mm |  |  kg |  |  |
|----------------|---|---|--|---|--|---|---|
| PK-0H30-2500-A |   | 250   | -  | petny<br>full<br>полное   | 15   | stal galvanizowana<br>galvanised steel<br>оцинкованная сталь                        | stal<br>steel<br>сталь  |
| PK-0H30-3000-A |   | 300   |  |   |  |   |   |
| PK-0H30-3500-A |   | 350   |  |   |  |   |   |
| PK-0H30-4000-A |   | 400   |  |   |  |   |   |



Prowadnica kulkowa H27  
Ball bearing slide H27  
Шариковая направляющая H27



|  |  |  L<br>mm |  AV<br>mm |  |  kg |  |  |
|--|---|---|--|---|--|---|---|
|  | PK-0H27-3000  | 300   | 109  | niepełny<br>partial<br>неполное   | 15   | ocynk<br>galvanized<br>гальваника   | stal<br>steel<br>сталь  |
|  | PK-0H27-3500  | 350   | 124  |   |  |   |   |
|  | PK-0H27-4000  | 400   | 134  |   |  |   |   |
|  | PK-0H27-4500  | 450   | 149  |   |  |   |   |
|  | PK-0H27-5000  | 500   | 184  |   |  |   |   |



Prowadnica kulkowa do półki pod klawiaturę H27  
 Ball bearing slide for keyboard H27  
 Шариковая направляющая для полки под клавиатуру H27

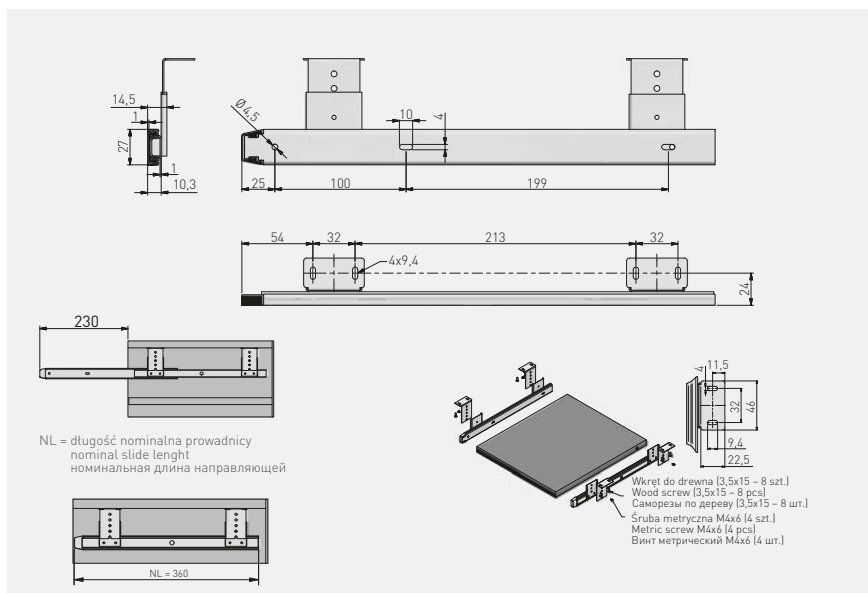

|              |           |                                 |         |                                   |                        |
|--------------|-----------|---------------------------------|---------|-----------------------------------|------------------------|
|              |           |                                 |         |                                   |                        |
| PK-0-000-027 | 360<br>mm | niepełny<br>partial<br>неполное | 5<br>kg | ocynk<br>galvanized<br>гальваника | stal<br>steel<br>сталь |





Prowadnica kulkowa H17  
 Ball bearing slide H17  
 Шариковая направляющая H17

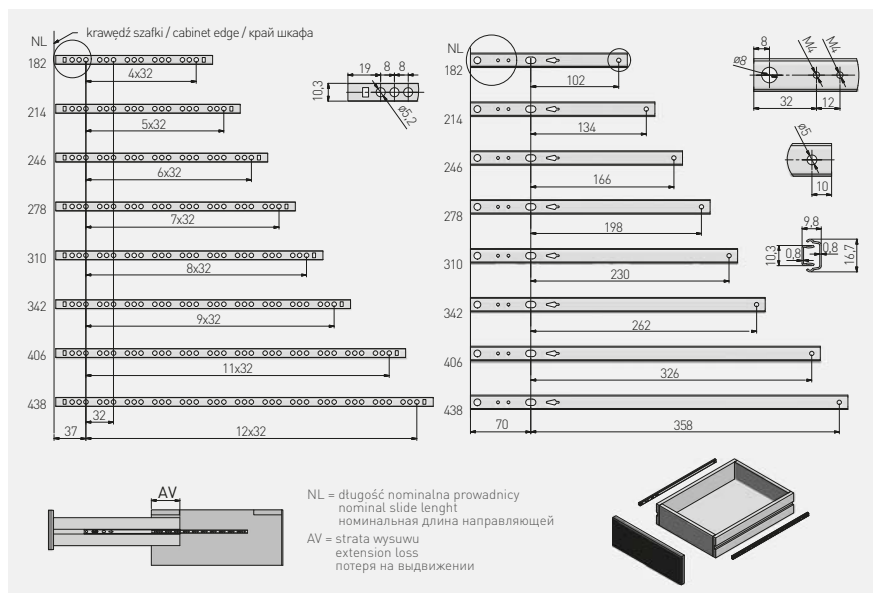

| PK-0H17182XP | L<br>mm | AV<br>mm |                                 | kg |                                   |                        |     |
|--------------|---------|----------|---------------------------------|----|-----------------------------------|------------------------|-----|
| PK-0H17214XP | 214     | 77       | niepełny<br>partial<br>неполное | 10 | ocynk<br>galvanized<br>гальваника | stal<br>steel<br>сталь | 100 |
| PK-0H17246XP | 246     |          |                                 |    |                                   |                        |     |
| PK-0H17278XP | 278     |          |                                 |    |                                   |                        |     |
| PK-0H17310XP | 310     |          |                                 |    |                                   |                        |     |
| PK-0H17342XP | 342     |          |                                 |    |                                   |                        |     |
| PK-0H17406XP | 406     |          |                                 |    |                                   |                        |     |
| PK-0H17438XP | 438     | 50       |                                 |    |                                   |                        |     |



Prowadnica rolkowa 0B  
Euro roller slide 0B  
Роликовая направляющая 0B

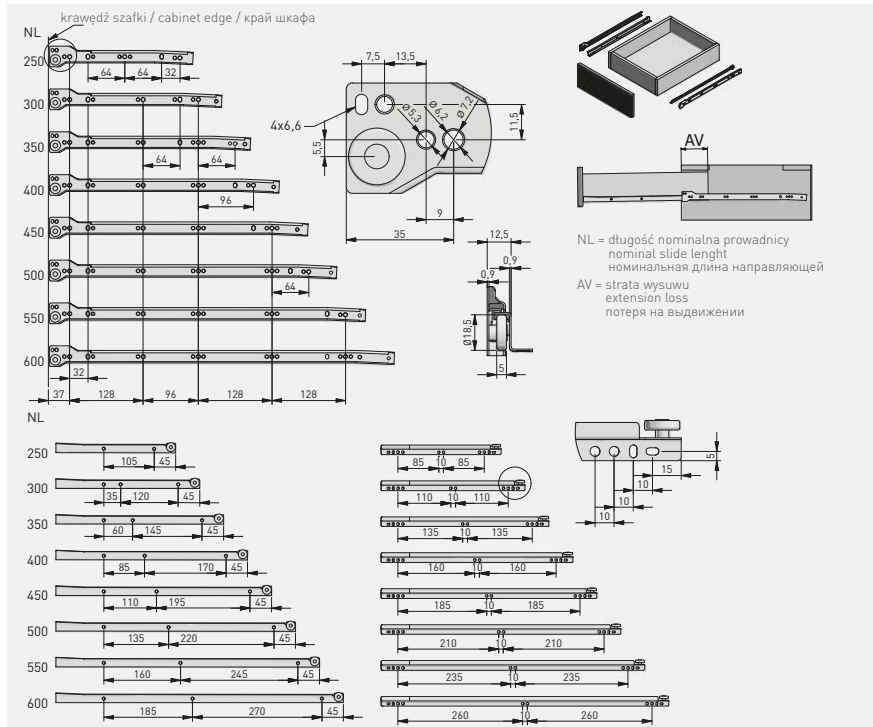









|              |     | L<br>mm | AV<br>mm |                                  |    |                         |                        |               | L<br>mm | AV<br>mm |                                  |    |                        |                        |
|--------------|-----|---------|----------|----------------------------------|----|-------------------------|------------------------|---------------|---------|----------|----------------------------------|----|------------------------|------------------------|
| PR-0B-250-10 |     | 250     |          | niepnytry<br>partial<br>неполное | 25 | biały<br>white<br>белый | stal<br>steel<br>сталь | PR-0B-250-18* |         | 250      | niepnytry<br>partial<br>неполное | 25 | szary<br>gray<br>серый | stal<br>steel<br>сталь |
| PR-0B-300-10 |     | 300     |          |                                  |    |                         |                        | PR-0B-300-18* |         | 300      |                                  |    |                        |                        |
| PR-0B-350-10 | 100 | 350     |          |                                  |    |                         |                        | PR-0B-350-18* | 100     | 350      |                                  |    |                        |                        |
| PR-0B-400-10 |     | 400     |          |                                  |    |                         |                        | PR-0B-400-18* |         | 400      |                                  |    |                        |                        |
| PR-0B-450-10 |     | 450     |          |                                  |    |                         |                        | PR-0B-450-18* |         | 450      |                                  |    |                        |                        |
| PR-0B-500-10 |     | 500     | 110      |                                  |    |                         |                        | PR-0B-500-18* |         | 500      |                                  |    |                        |                        |
| PR-0B-550-10 |     | 550     | 115      |                                  |    |                         |                        | PR-0B-550-18* |         | 550      |                                  |    |                        |                        |
| PR-0B-600-10 |     | 600     | 125      |                                  |    |                         |                        | PR-0B-600-18* |         | 600      |                                  |    |                        |                        |









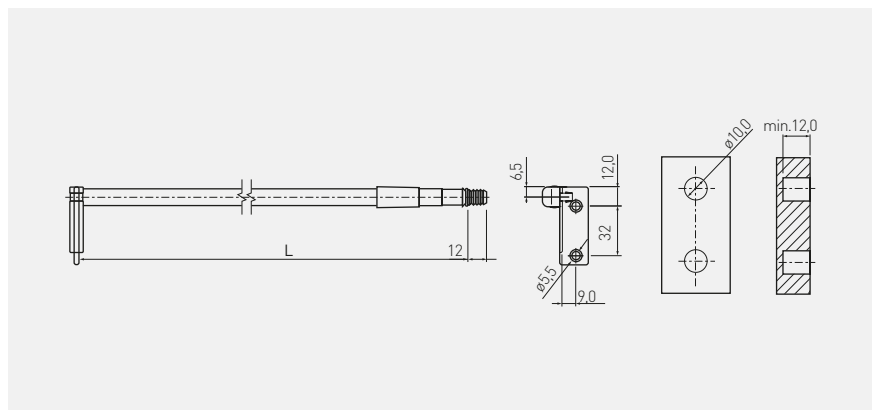

|              |  |  H<br>mm |  L<br>mm |  AV<br>mm |  |  kg |  |  |  |
|--------------|---|---|---|--|---|--|---|---|---|
| MP-054350-10 | 54  | 350   | 88  | niepełny<br>partial<br>неполное  | 25  | lakier<br>lacquer<br>лак   | biały<br>white<br>белый   | stal<br>steel<br>сталь  |   |
| MP-054400-10 |   | 400   | 98  |  |   |  |   |   |   |
| MP-054450-10 |   | 450   |   |  |   |  |   |   |   |
| MP-054500-10 |   | 500   |   |  |   |  |   |   |   |
| MP-054450-80 |   | 450   |   |  |   |  |   |   |   |
| MP-054500-80 |   | 500   | 86  |  |   |  |   |   | biały<br>white<br>белый   |
| MP-086270-10 | 270   | 88  |   |  |   |  |   |   |   |
| MP-086300-10 | 300   |   |   |  |   |  |   |   |   |
| MP-086350-10 | 350   |   |   |  |   |  |   |   |   |
| MP-086400-10 | 400   | 98  |   |  |   |  |   |   |   |
| MP-086450-10 | 450   |   |   |  |   |  |   |   |   |
| MP-086500-10 | 500   |   |   |  |   |  |   |   |   |
| MP-086550-10 | 550   |   | 118   |  |   |  |   |   |   |
| MP-086350-80 | 350   | 88  | niepełny<br>partial<br>неполное   | 25   | lakier<br>lacquer<br>лак  | szary<br>gray<br>серый   | stal<br>steel<br>сталь  |   |   |
| MP-086400-80 | 400   | 98  |   |  |   |  |   |   |   |
| MP-086450-80 | 450   |   |   |  |   |  |   |   |   |
| MP-086500-80 | 500   |   |   |  |   |  |   |   |   |
| MP-118350-10 | 350   |   |   |  |   |  |   | 88  | 118   |
| MP-118400-10 | 400   | 98  |   |  |   |  |   |   |   |
| MP-118450-10 | 450   |   |   |  |   |  |   |   |   |
| MP-118500-10 | 500   |   |   |  |   |  |   |   |   |
| MP-150270-10 | 270   | 88  | 150   | biały<br>white<br>белый  |   |  |   |   |   |
| MP-150300-10 | 300   |   |   |  |   |  |   |   |   |
| MP-150350-10 | 350   |   |   |  |   |  |   |   |   |
| MP-150400-10 | 400   | 98  |   |  |   |  |   |   |   |
| MP-150450-10 | 450   |   |   |  |   |  |   |   |   |
| MP-150500-10 | 500   |   |   |  |   |  |   |   |   |
| MP-150550-10 | 550   |   | 118   |  |   |  |   |   |   |
| MP-150350-80 | 350   | 88  | 150   | szary<br>gray<br>серый   |   |  |   |   |   |
| MP-150400-80 | 400   | 98  |   |  |   |  |   |   |   |
| MP-150450-80 | 450   |   |   |  |   |  |   |   |   |
| MP-150500-80 | 500   |   |   |  |   |  |   |   |   |

Reling z uchwytem ścianki tylnej lewy / prawy  
 Rail with back panel connector left / right  
 Релинг с креплением задней стенки левый / правый



|              |  |  L<br>mm |  |
|--------------|---|---|---|
| RS-SZ-400-10 |   | 393 / 404   | biały / white / белый   |
| RS-SZ-450-10 |   | 443 / 454   |   |
| RS-SZ-500-10 |   | 493 / 504   |   |

L – długość rzeczywista relingu mieszcząca się w przedziale [Lmin.; Lmax.] / actual length is within the range [Lmin.; Lmax.] / фактическая длина релинга в пределах [Lмин; Lмакс]



Spowalniacz do prowadnic rolkowych oraz szuflad typu Metalbox 350-550 mm  
 Soft closing device for euro roller slide and Metalbox 350-550 mm  
 Доводчик для роликовых направляющих и Металбоксов 350-550 мм



|   |   |   |   |
|---|---|---|---|
|  |  |  |  |
| AM-MBSOFT-P2  | 25  | szary<br>gray<br>серый  | tworzywo<br>plastic<br>пластмасса   |

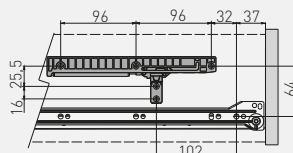

Prowadnica rolkowa / Euro roller slide /  
Роликовая направляющая

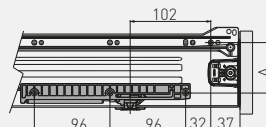



Metalbox / Metalbox / Металбокс

| wysokość boku (mm)<br>side height (mm) | A   |
|--|-----|
| высота боковой стенки (мм)             |     |
| 54                                     | 32  |
| 86                                     | 64  |
| 118                                    | 96  |
| 150                                    | 128 |

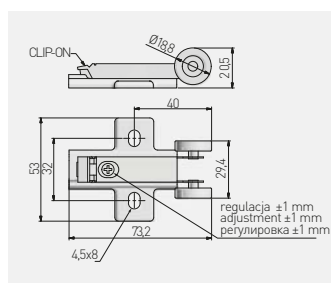
Rolla stabilizująca  
 Drawer stabilizer  
 Стабилизирующий ролик



Do szuflad skrzyniowych wyposażonych w prowadnice push to open  
 For drawers with push to open  
 Для ящиков с направляющими push to open

|   |   |   |
|---|---|---|
|  |  |  |
| PB-D-P20STAB  | nikiel / nickel / никель  | stal / steel / сталь  |



## AXIS PRO

Skład zestawu  
Set  
Комплектация

MOCOWANIE ŚCIANKI TYLNEJ  
niskie / średnie / wysokie / bardzo wysokie  
antracytowy / biały

BACK PANEL CONNECTOR  
low / medium / high / very high  
anthracite / white

КРЕПЛЕНИЕ ЗАДНЕЙ СТЕНКИ  
низкий / средний / высокий вариант / очень высокий  
антрацитовый / белый

ultracienki płaszcz boczny  
ultra thin drawer sides  
ультратонкие боковины

ZASŁEPKA OTWORÓW REGULACYJNYCH  
antracytowy / biały  
COVER CAP  
anthracite / white  
ЗАГЛУШКИ ДЛЯ ОТВЕРСТИЙ  
антрацитовый / белый

MOCOWANIE FRONTU + WKRETY  
FRONT CONNECTOR + SCREWS  
КРЕПЛЕНИЕ ФАСАДА + ШУРУПЫ

PROWADNICA  
L = 300-550 mm  
SLIDE  
L = 300-550 mm  
НАПРАВЛЯЮЩАЯ  
L = 300-550 mm

BOK SZUFLADY  
antracytowy / biały  
L = 300-550 mm  
DRAWER SIDE  
anthracite / white  
L = 300-550 mm  
БОКОВЫЕ СТЕНКИ  
антрацитовый / белый  
L = 300-550 mm





### AXIS PRO

Komplet szuflady niskiej A  
Low drawer set A  
Низкий ящик A

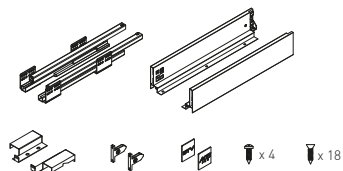

|                     | L<br>mm | kg |  |                          |
|---------------------|---------|----|--|--------------------------|
| PB-AXISPRO-KPL250A  | 250     | 40 | antracyt<br>anthracite<br>антрацитовый | lakier<br>lacquer<br>лак |
| PB-AXISPRO-KPL300A  | 300     |    |  |                          |
| PB-AXISPRO-KPL350A  | 350     |    |  |                          |
| PB-AXISPRO-KPL400A  | 400     |    |  |                          |
| PB-AXISPRO-KPL450A  | 450     |    |  |                          |
| PB-AXISPRO-KPL500A  | 500     |    |  |                          |
| PB-AXISPRO-KPL550A  | 550     |    | biały<br>white<br>белый                |                          |
| PB-AXISPRO-KPL600A  | 600     |    |  |                          |
| PB-AXISPRO-KPL250A1 | 250     |    |  |                          |
| PB-AXISPRO-KPL300A1 | 300     |    |  |                          |
| PB-AXISPRO-KPL350A1 | 350     |    |  |                          |
| PB-AXISPRO-KPL400A1 | 400     |    |  |                          |
| PB-AXISPRO-KPL450A1 | 450     |    |  |                          |
| PB-AXISPRO-KPL500A1 | 500     |    |  |                          |
| PB-AXISPRO-KPL550A1 | 550     |    |  |                          |
| PB-AXISPRO-KPL600A1 | 600     |    |  |                          |

### AXIS PRO

Komplet szuflady średniej B  
Medium drawer set B  
Средний ящик B

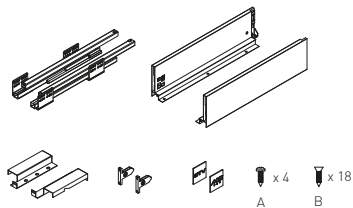

|                     | L<br>mm | kg |  |                          |
|---------------------|---------|----|--|--------------------------|
| PB-AXISPRO-KPL250B  | 250     | 40 | antracyt<br>anthracite<br>антрацитовый | lakier<br>lacquer<br>лак |
| PB-AXISPRO-KPL300B  | 300     |    |  |                          |
| PB-AXISPRO-KPL350B  | 350     |    |  |                          |
| PB-AXISPRO-KPL400B  | 400     |    |  |                          |
| PB-AXISPRO-KPL450B  | 450     |    |  |                          |
| PB-AXISPRO-KPL500B  | 500     |    |  |                          |
| PB-AXISPRO-KPL550B  | 550     |    | biały<br>white<br>белый                |                          |
| PB-AXISPRO-KPL600B  | 600     |    |  |                          |
| PB-AXISPRO-KPL250B1 | 250     |    |  |                          |
| PB-AXISPRO-KPL300B1 | 300     |    |  |                          |
| PB-AXISPRO-KPL350B1 | 350     |    |  |                          |
| PB-AXISPRO-KPL400B1 | 400     |    |  |                          |
| PB-AXISPRO-KPL450B1 | 450     |    |  |                          |
| PB-AXISPRO-KPL500B1 | 500     |    |  |                          |
| PB-AXISPRO-KPL550B1 | 550     |    |  |                          |
| PB-AXISPRO-KPL600B1 | 600     |    |  |                          |

### AXIS PRO

Komplet szuflady wysokiej C  
High drawer set C  
Высокий ящик C

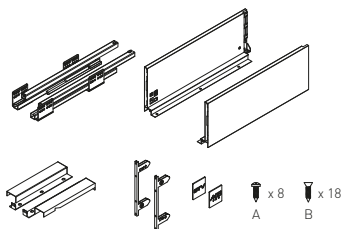

| Model               | Height (mm) | Color                                  | Finish                   | Material               |
|---------------------|-------------|--|--------------------------|------------------------|
| PB-AXISPRO-KPL250C  | 250         | antracyt<br>anthracite<br>антрацитовый | lakier<br>lacquer<br>лак | stal<br>steel<br>сталь |
| PB-AXISPRO-KPL300C  | 300         |  |                          |                        |
| PB-AXISPRO-KPL350C  | 350         |  |                          |                        |
| PB-AXISPRO-KPL400C  | 400         |  |                          |                        |
| PB-AXISPRO-KPL450C  | 450         |  |                          |                        |
| PB-AXISPRO-KPL500C  | 500         |  |                          |                        |
| PB-AXISPRO-KPL550C  | 550         | biały<br>white<br>белый                |                          |                        |
| PB-AXISPRO-KPL600C  | 600         |  |                          |                        |
| PB-AXISPRO-KPL250C1 | 250         |  |                          |                        |
| PB-AXISPRO-KPL300C1 | 300         |  |                          |                        |
| PB-AXISPRO-KPL350C1 | 350         |  |                          |                        |
| PB-AXISPRO-KPL400C1 | 400         |  |                          |                        |
| PB-AXISPRO-KPL450C1 | 450         |  |                          |                        |
| PB-AXISPRO-KPL500C1 | 500         |  |                          |                        |
| PB-AXISPRO-KPL550C1 | 550         |  |                          |                        |
| PB-AXISPRO-KPL600C1 | 600         |  |                          |                        |



### AXIS PRO

Komplet szuflady bardzo wysokiej D  
Very high drawer set D  
Очень высокий ящик D

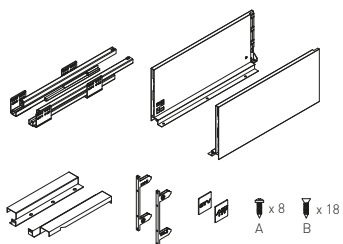

| Model               | Height (mm) | Color                                  | Finish                   | Material               |
|---------------------|-------------|--|--------------------------|------------------------|
| PB-AXISPRO-KPL250D  | 250         | antracyt<br>anthracite<br>антрацитовый | lakier<br>lacquer<br>лак | stal<br>steel<br>сталь |
| PB-AXISPRO-KPL300D  | 300         |  |                          |                        |
| PB-AXISPRO-KPL350D  | 350         |  |                          |                        |
| PB-AXISPRO-KPL400D  | 400         |  |                          |                        |
| PB-AXISPRO-KPL450D  | 450         |  |                          |                        |
| PB-AXISPRO-KPL500D  | 500         |  |                          |                        |
| PB-AXISPRO-KPL550D  | 550         | biały<br>white<br>белый                |                          |                        |
| PB-AXISPRO-KPL600D  | 600         |  |                          |                        |
| PB-AXISPRO-KPL250D1 | 250         |  |                          |                        |
| PB-AXISPRO-KPL300D1 | 300         |  |                          |                        |
| PB-AXISPRO-KPL350D1 | 350         |  |                          |                        |
| PB-AXISPRO-KPL400D1 | 400         |  |                          |                        |
| PB-AXISPRO-KPL450D1 | 450         |  |                          |                        |
| PB-AXISPRO-KPL500D1 | 500         |  |                          |                        |
| PB-AXISPRO-KPL550D1 | 550         |  |                          |                        |
| PB-AXISPRO-KPL600D1 | 600         |  |                          |                        |



## AXIS PRO

Komplet szuflady ekstra niskiej  
Very low drawer set  
Набор очень низких ящиков

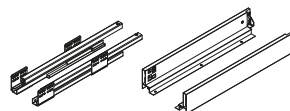

|                         |  | <br>L<br>mm | <br>kg |  |                          |                        |
|-------------------------|--|-------------|--------|--|--------------------------|------------------------|
| PB-AXISPRO-KPL69-450-60 |  | 450         | 40     |  |                          |                        |
| PB-AXISPRO-KPL69-500-60 |  | 500         |        |  |                          |                        |
| PB-AXISPRO-KPL69-450-10 |  | 450         |        |  |                          |                        |
| PB-AXISPRO-KPL69-500-10 |  | 500         |        |  |                          |                        |
|                         |  |             |        | antracyt<br>anthracite<br>антрацитовый | lakier<br>lacquer<br>лак | stal<br>steel<br>сталь |
|                         |  |             |        | biały<br>white<br>белый                |                          |                        |

## AXIS PRO PUSH TO OPEN

Komplet szuflady niskiej A  
Low drawer set A  
Низкий ящик A

**NEW**

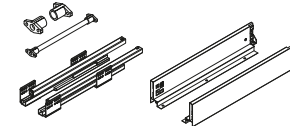

|                            |  | <br>L<br>mm | <br>kg |  |                          |                        |
|----------------------------|--|-------------|--------|--|--------------------------|------------------------|
| PB-AXISPRO-P20-KPL250A     |  | 250         | 40     |  |                          |                        |
| PB-AXISPRO-P20-KPL300A     |  | 300         |        |  |                          |                        |
| PB-AXISPRO-P20-KPL350A     |  | 350         |        |  |                          |                        |
| PB-AXISPRO-P20-KPL400A     |  | 400         |        |  |                          |                        |
| PB-AXISPRO-P20-KPL450A     |  | 450         |        |  |                          |                        |
| PB-AXISPRO-P20-KPL500A     |  | 500         |        |  |                          |                        |
| PB-AXISPRO-P20-KPL550A     |  | 550         |        |  |                          |                        |
| PB-AXISPRO-P20-KPL600A     |  | 600         |        |  |                          |                        |
| PB-AXISPRO-P20-KPL250A1    |  | 250         |        |  |                          |                        |
| PB-AXISPRO-P20-KPL300A1    |  | 300         |        |  |                          |                        |
| PB-AXISPRO-P20-KPL350A1    |  | 350         |        |  |                          |                        |
| PB-AXISPRO-P20-KPL400A1    |  | 400         |        |  |                          |                        |
| PB-AXISPRO-P20-KPL450A1    |  | 450         |        |  |                          |                        |
| PB-AXISPRO-P20-KPL500A1    |  | 500         |        |  |                          |                        |
| PB-AXISPRO-P20-KPL550A1    |  | 550         |        |  |                          |                        |
| PB-AXISPRO-P20-KPL600A1    |  | 600         |        |  |                          |                        |
| PB-AXISPRO-SYNCHRO-P20     |  | 1100        | -      | -                                      | -                        | -                      |
| PB-AXISPRO-SYNCHRO-P20-MOC |  | -           | -      | -                                      | -                        | -                      |
|                            |  |             |        | antracyt<br>anthracite<br>антрацитовый | lakier<br>lacquer<br>лак | stal<br>steel<br>сталь |
|                            |  |             |        | biały<br>white<br>белый                |                          |                        |



### AXIS PRO PUSH TO OPEN

Komplet szuflady bardzo wysokiej D  
Very high drawer set D  
Очень высокий ящик D

NEW

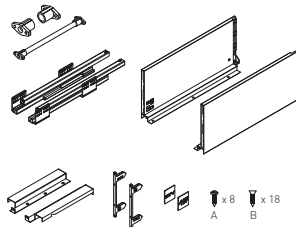

|                            | L<br>mm | kg |   |   |   |
|----------------------------|---------|----|---|---|---|
| PB-AXISPRO-P20-KPL250D     | 250     | 40 |   |   |   |
| PB-AXISPRO-P20-KPL300D     | 300     |    |   |   |   |
| PB-AXISPRO-P20-KPL350D     | 350     |    |   |   |   |
| PB-AXISPRO-P20-KPL400D     | 400     |    |   |   |   |
| PB-AXISPRO-P20-KPL450D     | 450     |    |   |   |   |
| PB-AXISPRO-P20-KPL500D     | 500     |    |   |   |   |
| PB-AXISPRO-P20-KPL550D     | 550     |    |   |   |   |
| PB-AXISPRO-P20-KPL600D     | 600     |    |   |   |   |
| PB-AXISPRO-P20-KPL250D1    | 250     |    |   |   |   |
| PB-AXISPRO-P20-KPL300D1    | 300     |    |   |   |   |
| PB-AXISPRO-P20-KPL350D1    | 350     |    |   |   |   |
| PB-AXISPRO-P20-KPL400D1    | 400     |    |   |   |   |
| PB-AXISPRO-P20-KPL450D1    | 450     |    |   |   |   |
| PB-AXISPRO-P20-KPL500D1    | 500     |    |   |   |   |
| PB-AXISPRO-P20-KPL550D1    | 550     |    |   |   |   |
| PB-AXISPRO-P20-KPL600D1    | 600     |    |   |   |   |
| PB-AXISPRO-SYNCHRO-P20     | 1100    | -  | - | - | - |
| PB-AXISPRO-SYNCHRO-P20-MOC | -       | -  | - | - | - |



### Złączka frontu wewnętrznego niska

Inner front connector low

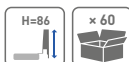
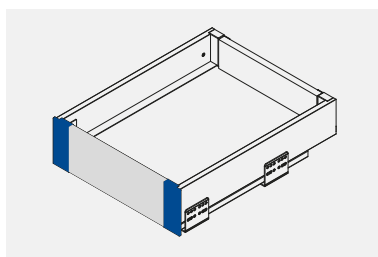

Соединитель передней панели, низкий



| PB-AXISPRO-WEWMOCA  | antracyt<br>anthracite<br>антрацитовый |  |  |  |
|---------------------|--|--|--|--|
| PB-AXISPRO-WEWMOCA1 | biały<br>white<br>белый                |  |  |  |

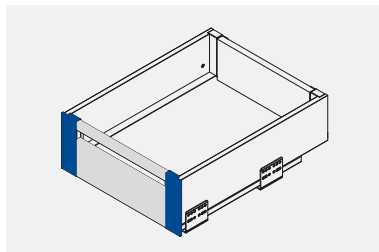

Złączka frontu wewnętrznego średnia  
 Inner front connector medium  
 Соединитель передней панели, средний



|   |   |   |
|---|---|---|
|  |  |  |
| PB-AXISPRO-WEWMOCB  | antracyt<br>anthracite<br>антрацитовый  | stal<br>steel<br>сталь  |
| PB-AXISPRO-WEWMOCB1   | biały<br>white<br>белый   |   |

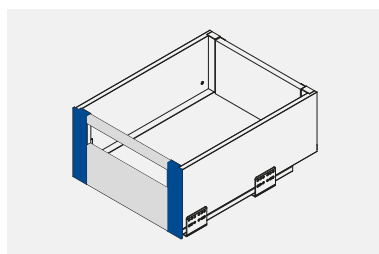

Złączka frontu wewnętrznego wysoka  
 Inner front connector high  
 Соединитель передней панели, высокий



|   |   |   |
|---|---|---|
|  |  |  |
| PB-AXISPRO-WEWMOCC  | antracyt<br>anthracite<br>антрацитовый  | stal<br>steel<br>сталь  |
| PB-AXISPRO-WEWMOCC1   | biały<br>white<br>белый   |   |

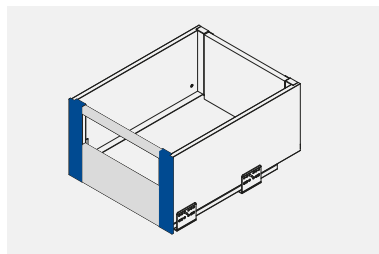



Złączka frontu wewnętrznego bardzo wysoka  
 Inner front connector very high  
 Соединитель передней панели, очень высокий

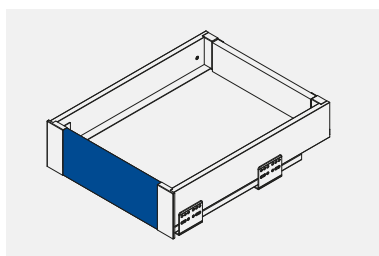
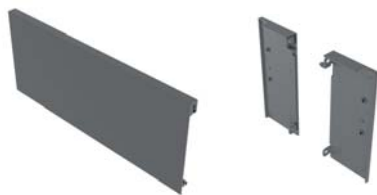

|                     |  |  |  |
|---------------------|---|---|---|
| PB-AXISPRO-WEWMOCD  |   | antracyt<br>anthracite<br>антрацитовый  | stal<br>steel<br>сталь  |
| PB-AXISPRO-WEWMOCD1 |   | biały<br>white<br>белый   |   |





Zestaw do szuflady wewnętrznej niskiej  
 Set for low inside drawer  
 Набор для внутреннего нижнего ящика

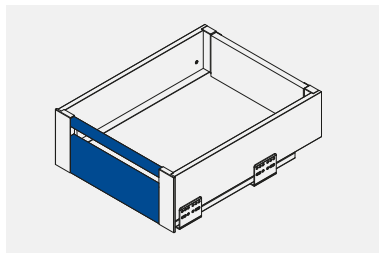

|                      |  |  H<br>mm |  L<br>mm |  |  |
|----------------------|---|---|---|---|---|
| PB-AXISPRO-ZESWEW-A  |   | 110   | 1200  | antracyt<br>anthracite<br>антрацитовый  | stal<br>steel<br>сталь  |
| PB-AXISPRO-ZESWEW-A1 |   |   |   | biały<br>white<br>белый   |   |





Zestaw do szuflady wewnętrznej średniej  
Set for medium inside drawer  
Набор для среднего внутреннего ящика

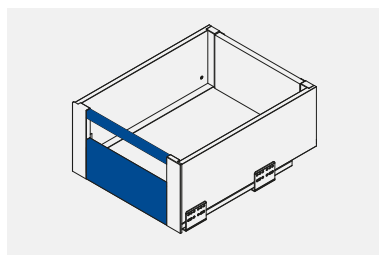
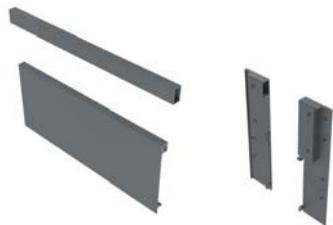

|                      |  |  H<br>mm |  L<br>mm |  |  |
|----------------------|---|---|---|---|---|
| PB-AXISPRO-ZESWEW-B  |   | 95  | 1200  | antracyt<br>anthracite<br>антрацитовый  | stal<br>steel<br>сталь  |
| PB-AXISPRO-ZESWEW-B1 |   |   |   | biały<br>white<br>белый   |   |

Zestaw do szuflady wewnętrznej wysokiej  
Set for high inside drawer  
Набор для внутреннего высокого ящика





|                      |  |  H<br>mm |  L<br>mm |  |  |
|----------------------|---|---|---|---|---|
| PB-AXISPRO-ZESWEW-C  |   | 110   | 1200  | antracyt<br>anthracite<br>антрацитовый  | stal<br>steel<br>сталь  |
| PB-AXISPRO-ZESWEW-C1 |   |   |   | biały<br>white<br>белый   |   |



Zestaw do szuflady wewnętrznej bardzo wysokiej  
 Set for very high inside drawer  
 Набор для очень высокого внутреннего ящика



|                      |     |      |                                      |                        |
|----------------------|-----|------|--------------------------------------|------------------------|
| PB-AXISPRO-ZESWEW-D  | 110 | 1200 | antracyt / anthracite / антрацитовый | stal<br>steel<br>сталь |
| PB-AXISPRO-ZESWEW-D1 |     |      | biały / white / белый                |                        |

Reling wzdluzny kwadratowy  
 Square longitudinal railing  
 Квадратные продольные рейлинги





|                     |     |  |                        |
|---------------------|-----|--|------------------------|
| PB-AXISPRO-RELKW300 | 300 | antracyt<br>anthracite<br>антрацитовый | stal<br>steel<br>сталь |
| PB-AXISPRO-RELKW350 | 350 |  |                        |
| PB-AXISPRO-RELKW400 | 400 |  |                        |
| PB-AXISPRO-RELKW450 | 450 |  |                        |
| PB-AXISPRO-RELKW500 | 500 |  |                        |
| PB-AXISPRO-RELKW550 | 550 |  |                        |

|                        |     |                         |                        |
|------------------------|-----|-------------------------|------------------------|
| PB-AXISPRO-RELKW300-10 | 300 | biały<br>white<br>белый | stal<br>steel<br>сталь |
| PB-AXISPRO-RELKW350-10 | 350 |                         |                        |
| PB-AXISPRO-RELKW400-10 | 400 |                         |                        |
| PB-AXISPRO-RELKW450-10 | 450 |                         |                        |
| PB-AXISPRO-RELKW500-10 | 500 |                         |                        |
| PB-AXISPRO-RELKW550-10 | 550 |                         |                        |

Znacznik do mocowania frontów AxisPro  
 Marker for fixing AxisPro front panels  
 Маркер для монтажа фасадов AxisPro



|                        |                                   |
|------------------------|-----------------------------------|
| PB-AXISPRO-ZNACZ-FRONT | tworzywo<br>plastic<br>пластмасса |
|------------------------|-----------------------------------|

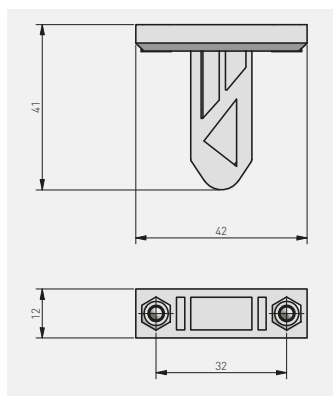

## Modern Box Square

Skład zestawu  
Set  
Комплектация

## MOCOWANIE ŚCIANKI TYLNEJ

niskie / średnie / wysokie  
szare / białe

## BACK PANEL CONNECTOR

low / medium / high  
gray / white

## КРЕПЛЕНИЕ ЗАДНЕЙ СТЕНКИ

низкий / средний / высокий вариант  
серый / белый

## REILING WZDŁUŻNY

szary / biały  
L = 250-550 mm

## LONGITUDINAL RAIL

gray / white  
L = 250-550 mm

## ПРОДОЛЬНЫЙ РЕЙЛИНГ

серый / белый  
L = 250-550 мм

## MOCOWANIE FRONTU + WKRETY

FRONT CONNECTOR + SCREWS  
КРЕПЛЕНИЕ ФАСАДА + ШРУПЫ

## ZAŚLĘPKA OTWORÓW REGULACYJNYCH

szara / biała

COVER CAP

gray / white

ЗАГЛУШКИ ДЛЯ ОТВЕРСТИЙ

серый / белый

## PROWADNICA

L = 250-550 mm

SLIDE

L = 250-550 mm

НАПРАВЛЯЮЩАЯ

L = 250-550 mm

## BOK SZUFLADY

szary / biały

L = 250-550 mm

DRAWER SIDE

gray / white

L = 250-550 mm

БОКОВЫЕ СТЕНКИ

серый / белый







L = 250-550 мм

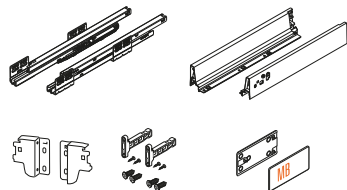

### Modern Box Square

Komplet szuflady niskiej A  
Low drawer set A  
Низкий ящик А







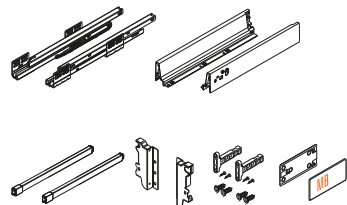

|                |  |  L<br>mm |  kg<br>↓ |  |  |  |
|----------------|---|--|---|---|---|---|
| PB-KW-KPL250A  | 250   | 40   | szary<br>gray<br>серый  | lakier<br>lacquer<br>лак  | stal<br>steel<br>сталь  |   |
| PB-KW-KPL300A  | 300   |  |   |   |   |   |
| PB-KW-KPL350A  | 350   |  |   |   |   |   |
| PB-KW-KPL400A  | 400   |  |   |   |   |   |
| PB-KW-KPL450A  | 450   |  |   |   |   |   |
| PB-KW-KPL500A  | 500   |  |   |   |   |   |
| PB-KW-KPL550A  | 550   |  |   |   |   |   |
| PB-KW-KPL600A  | 600   |  |   |   |   |   |
| PB-KW-KPL250A1 | 250   |  |   |   |   | biały<br>white<br>белый   |
| PB-KW-KPL300A1 | 300   |  |   |   |   |   |
| PB-KW-KPL350A1 | 350   |  |   |   |   |   |
| PB-KW-KPL400A1 | 400   |  |   |   |   |   |
| PB-KW-KPL450A1 | 450   |  |   |   |   |   |
| PB-KW-KPL500A1 | 500   |  |   |   |   |   |
| PB-KW-KPL550A1 | 550   |  |   |   |   |   |
| PB-KW-KPL600A1 | 600   |  |   |   |   |   |

### Modern Box Square

Komplet szuflady średniej B  
Medium drawer set B  
Средний ящик В



|                |  |  L<br>mm |  kg<br>↓ |  |  |  |
|----------------|---|---|---|---|---|---|
| PB-KW-KPL250B  | 250   | 40  | szary<br>gray<br>серый  | lakier<br>lacquer<br>лак  | stal<br>steel<br>сталь  |   |
| PB-KW-KPL300B  | 300   |   |   |   |   |   |
| PB-KW-KPL350B  | 350   |   |   |   |   |   |
| PB-KW-KPL400B  | 400   |   |   |   |   |   |
| PB-KW-KPL450B  | 450   |   |   |   |   |   |
| PB-KW-KPL500B  | 500   |   |   |   |   |   |
| PB-KW-KPL550B  | 550   |   |   |   |   |   |
| PB-KW-KPL600B  | 600   |   |   |   |   |   |
| PB-KW-KPL250B1 | 250   |   |   |   |   | biały<br>white<br>белый   |
| PB-KW-KPL300B1 | 300   |   |   |   |   |   |
| PB-KW-KPL350B1 | 350   |   |   |   |   |   |
| PB-KW-KPL400B1 | 400   |   |   |   |   |   |
| PB-KW-KPL450B1 | 450   |   |   |   |   |   |
| PB-KW-KPL500B1 | 500   |   |   |   |   |   |
| PB-KW-KPL550B1 | 550   |   |   |   |   |   |
| PB-KW-KPL600B1 | 600   |   |   |   |   |   |

### Modern Box Square

Komplet szuflady wysokiej C  
High drawer set C  
Высокий ящик C

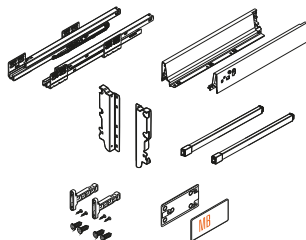

|                | L<br>mm | kg |    |                         |                          |                        |
|----------------|---------|----|----|-------------------------|--------------------------|------------------------|
| PB-KW-KPL250C  | 250     |    | 40 | szary<br>gray<br>серый  | lakier<br>lacquer<br>лак | stal<br>steel<br>сталь |
| PB-KW-KPL300C  | 300     |    |    |                         |                          |                        |
| PB-KW-KPL350C  | 350     |    |    |                         |                          |                        |
| PB-KW-KPL400C  | 400     |    |    |                         |                          |                        |
| PB-KW-KPL450C  | 450     |    |    |                         |                          |                        |
| PB-KW-KPL500C  | 500     |    |    |                         |                          |                        |
| PB-KW-KPL550C  | 550     |    |    | biały<br>white<br>белый | lakier<br>lacquer<br>лак | stal<br>steel<br>сталь |
| PB-KW-KPL600C  | 600     |    |    |                         |                          |                        |
| PB-KW-KPL250C1 | 250     |    |    |                         |                          |                        |
| PB-KW-KPL300C1 | 300     |    |    |                         |                          |                        |
| PB-KW-KPL350C1 | 350     |    |    |                         |                          |                        |
| PB-KW-KPL400C1 | 400     |    |    |                         |                          |                        |
| PB-KW-KPL450C1 | 450     |    |    |                         |                          |                        |
| PB-KW-KPL500C1 | 500     |    |    |                         |                          |                        |
| PB-KW-KPL550C1 | 550     |    |    |                         |                          |                        |
| PB-KW-KPL600C1 | 600     |    |    |                         |                          |                        |

### Reling wzdużny Longitudinal drawer rail Продольный рейлинг

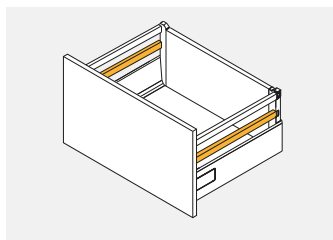

|               | L<br>mm |                        |                          |                        |
|---------------|---------|------------------------|--------------------------|------------------------|
| PB-D-RELKW350 | 350     | szary<br>gray<br>серый | lakier<br>lacquer<br>лак | stal<br>steel<br>сталь |
| PB-D-RELKW400 | 400     |                        |                          |                        |
| PB-D-RELKW450 | 450     |                        |                          |                        |
| PB-D-RELKW500 | 500     |                        |                          |                        |
| PB-D-RELKW550 | 550     |                        |                          |                        |

|                  | L<br>mm |                         |                          |                        |
|------------------|---------|-------------------------|--------------------------|------------------------|
| PB-D-RELKW350-10 | 350     | biały<br>white<br>белый | lakier<br>lacquer<br>лак | stal<br>steel<br>сталь |
| PB-D-RELKW400-10 | 400     |                         |                          |                        |
| PB-D-RELKW450-10 | 450     |                         |                          |                        |
| PB-D-RELKW500-10 | 500     |                         |                          |                        |
| PB-D-RELKW550-10 | 550     |                         |                          |                        |



Złączka frontu wewnętrznego, niska  
 Inner front connector, low  
 Соединитель передней панели, низкий

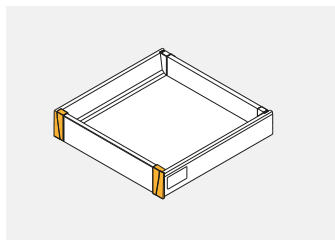

|                    |   |                       |                                   |
|--------------------|---|-----------------------|-----------------------------------|
| PB-D-WEWMOCA-KW    | szuflada niska A<br>low drawer A<br>низкий ящик A | szary / gray / серый  | tworzywo<br>plastic<br>пластмасса |
| PB-D-WEWMOCA-KW-10 |   | biały / white / белый |                                   |



Złączka frontu wewnętrznego, średnia  
 Inner front connector, medium  
 Соединитель передней панели, средний

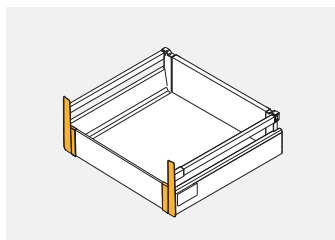

|                    |   |                       |                                   |
|--------------------|---|-----------------------|-----------------------------------|
| PB-D-WEWMOCB-KW    | szuflada średnia B<br>medium drawer B<br>средний ящик B | szary / gray / серый  | tworzywo<br>plastic<br>пластмасса |
| PB-D-WEWMOCB-KW-10 |   | biały / white / белый |                                   |



Złączka frontu wewnętrznego, wysoka  
 Inner front connector, high  
 Соединитель передней панели, высокий

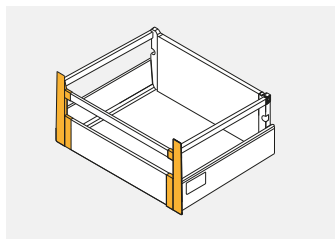

|                    |  |                       |                                   |
|--------------------|--|-----------------------|-----------------------------------|
| PB-D-WEWMOCC-KW    | szuflada wysoka C<br>high drawer C<br>высокий ящик C | szary / gray / серый  | tworzywo<br>plastic<br>пластмасса |
| PB-D-WEWMOCC-KW-10 |  | biały / white / белый |                                   |



Zestaw do szuflady wewnętrznej wysokiej Modern Box Square  
 Set for high inside drawer Modern Box Square  
 Набор для внутреннего высокого ящика Modern Box Square

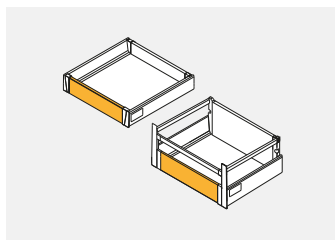

|                    |      |                       |                                    |
|--------------------|------|-----------------------|------------------------------------|
| PB-D-ZESWEWKW-C    | 1100 | szary / gray / серый  | aluminium<br>aluminium<br>алюминий |
| PB-D-ZESWEWKW-C-10 |      | biały / white / белый |                                    |



Zestaw do organizacji szuflady wewnętrznej Modern Box Square  
 Set for inside drawer organization Modern Box Square  
 Комплект для внутренней организации ящиков Modern Box Square

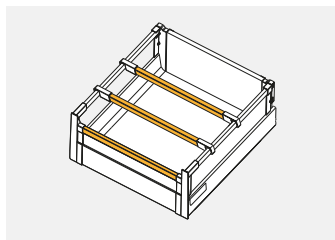

|   |   |   |   |
|---|---|---|---|
|  | <br>mm |  |  |
| PB-D-WEWORGKW-A   | 1100  | szary / gray / серый  | stal<br>steel<br>сталь  |
| PB-D-WEWORGKW-A-10  |   | biały / white / белый   |   |



Łącznik relingu poprzecznego  
 Transverse rail connector  
 Соединитель поперечного рейлинга

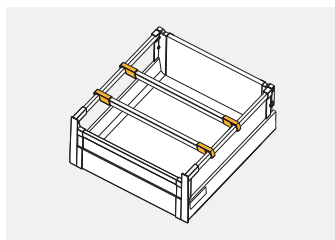

|   |   |   |   |
|---|---|---|---|
|  |  |  |  |
| PB-D-ZR-KW-00   | 1 kpl. = 2 szt.<br>1 set = 2 pcs<br>1 комп. = 2 шт.                                 | szary / gray / серый  | tworzywo<br>plastic<br>пластмасса   |
| PB-D-ZR-KW-10   |   | biały / white / белый   |   |



Zestaw do organizacji szuflady wewnętrznej  
 Set for inside drawer organization  
 Комплект для внутренней организации ящиков

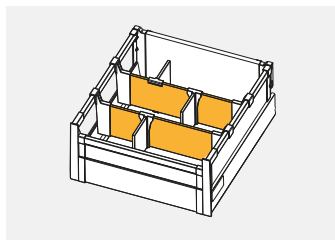

|   |   |   |   |
|---|---|---|---|
|  | <br>mm |  |  |
| PB-D-WEWORGKW-B   | 1100  | szary / gray / серый  | aluminium<br>aluminium<br>алюминий  |
| PB-D-WEWORGKW-B-10  |   | biały / white / белый   |   |



Złączka do listwy poprzecznej  
 Transverse bar connector  
 Соединитель поперечной планки

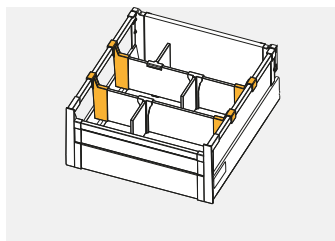

|   |   |   |   |
|---|---|---|---|
|  |  |  |  |
| PB-D-CONREL-KW  | 1 kpl. = 2 szt.<br>1 set = 2 pcs<br>1 комп. = 2 шт.                                 | szary / gray / серый  | tworzywo<br>plastic<br>пластмасса   |
| PB-D-CONREL-KW-10   |   | biały / white / белый   |   |





Przegroda do listwy poprzecznej  
 Transverse bar divider  
 Перегородка для поперечной планки

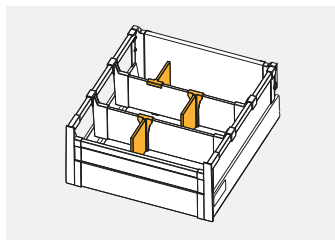

|                    |                |                       |                                   |
|--------------------|----------------|-----------------------|-----------------------------------|
| PB-D-PRZEGLP-KW    | 1 szt.<br>1 pc | szary / gray / серый  | tworzywo<br>plastic<br>пластмасса |
| PB-D-PRZEGLP-KW-10 | 1 шт.          | biały / white / белый |                                   |



Mocowanie relingu do podwyższonej ścianki tylnej  
 Back panel connector for rails, additional  
 Соединитель задней стенки для рейлингов, дополнительная

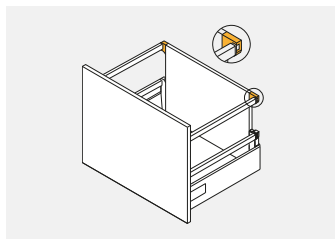





|              |                                  |                       |                                   |
|--------------|----------------------------------|-----------------------|-----------------------------------|
| PB-D-D2R0-00 | 1 kpl. = 2 szt.<br>1 set = 2 pcs | szary / gray / серый  | tworzywo<br>plastic<br>пластмасса |
| PB-D-D2R0-01 | 1 комп. = 2 шт.                  | biały / white / белый |                                   |

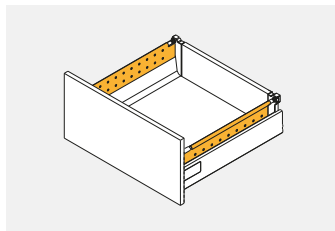
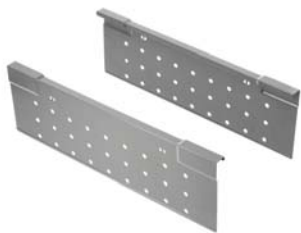

Bok perforowany  
Perforated side  
Перфорированная боковина



|  |  L<br>mm |  |  |
|---|---|---|---|
| PB-D-BXSIDEKW25C  | 250   | szary<br>gray<br>серый  | stal<br>steel<br>сталь  |
| PB-D-BXSIDEKW30C  | 300   |   |   |
| PB-D-BXSIDEKW35C  | 350   |   |   |
| PB-D-BXSIDEKW40C  | 400   |   |   |
| PB-D-BXSIDEKW45C  | 450   |   |   |
| PB-D-BXSIDEKW50C  | 500   |   |   |
| PB-D-BXSIDEKW55C  | 550   |   |   |
| PB-D-BXSIDEKW25C-10   | 250   | biały<br>white<br>белый   |   |
| PB-D-BXSIDEKW30C-10   | 300   |   |   |
| PB-D-BXSIDEKW35C-10   | 350   |   |   |
| PB-D-BXSIDEKW40C-10   | 400   |   |   |
| PB-D-BXSIDEKW45C-10   | 450   |   |   |
| PB-D-BXSIDEKW50C-10   | 500   |   |   |
| PB-D-BXSIDEKW55C-10   | 550   |   |   |



Złącza ścianki tylnej, niska  
 Back panel connector, low  
 Держатель задней стенки, низкий

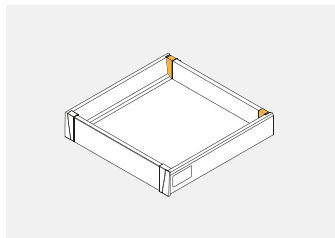





|   |   |   |   |
|---|---|---|---|
|  |  |  |  |
| PB-D-N2R0-00  | 1 kpl. = L+P<br>1 set = L+R   | szary / gray / серый  | stal<br>steel   |
| PB-D-N2R0-01  | 1 комп. = Л+П   | biały / white / белый   | сталь   |

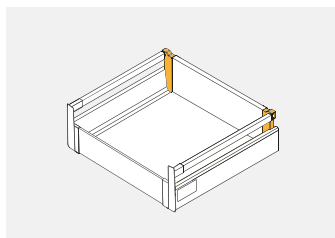

Złącza ścianki tylnej, średnia  
 Back panel connector, medium  
 Держатель задней стенки, средний



|   |   |   |   |
|---|---|---|---|
|  |  |  |  |
| PB-D-S2R0-00  | 1 kpl. = L+P<br>1 set = L+R   | szary / gray / серый  | stal<br>steel   |
| PB-D-S2R0-01  | 1 комп. = Л+П   | biały / white / белый   | сталь   |



Złączka ścianki tylnej, wysoka  
 Back panel connector, high  
 Держатель задней стенки, высокий

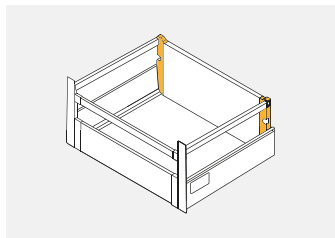

|              |                             |                       |               |
|--------------|-----------------------------|-----------------------|---------------|
| PB-D-W2R0-00 | 1 kpl. = L+P<br>1 set = L+R | szary / gray / серый  | stal<br>steel |
| PB-D-W2R0-01 | 1 комп. = Л+П               | biały / white / белый | stal<br>steel |



Mocowanie do relingów  
 Rails mounting  
 Держатель рейлинга



|               |                         |                        |                                   |
|---------------|-------------------------|------------------------|-----------------------------------|
| PB-D-MHG04-KW | 1 szt.<br>1 pc<br>1 шт. | szary<br>gray<br>серый | tworzywo<br>plastic<br>пластмасса |
|---------------|-------------------------|------------------------|-----------------------------------|



Matryca do relingów  
 Marking gauge for rails  
 Матрица для рейлингов



|   |   |   |   |
|---|---|---|---|
|  |  |  |  |
| PB-D-MATRYCA  | 1 kpl. = 1 szt.<br>1 set = 1 pc<br>1 комп. = 1 шт.                                | szary<br>gray<br>серый  | tworzywo<br>plastic<br>пластмасса   |



Znacznik do frontów  
 Marking gauge for drawer front  
 Маркер фасада



|   |   |   |   |
|---|---|---|---|
|  |  |  |  |
| PB-D-ZNACZ-0  | 1 kpl. = 2 szt.<br>1 set = 2 pcs<br>1 комп. = 2 шт.                                 | szary<br>gray<br>серый  | ZnAl  |



## Modern Box



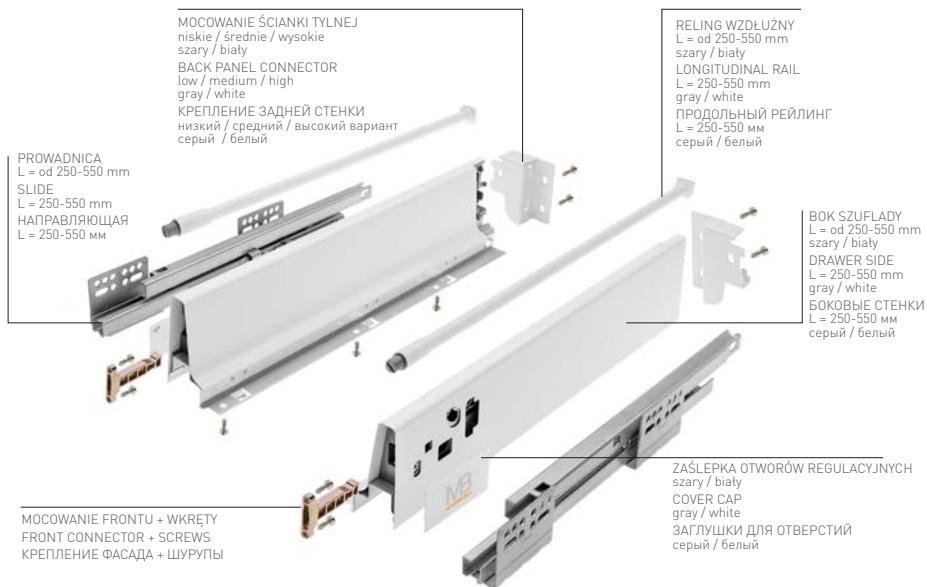



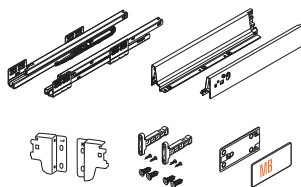

Sklad zestawu  
Set  
Комплектация



## Modern Box

Komplet szuflady niskiej A  
Low drawer set A  
Низкий ящик А



|  |  L<br>mm |  |  kg |  |  |  |
|---|---|---|--|---|---|---|
| PB-D-KPL250A  | 250   | soft close  | 40   | szary<br>gray<br>серый  |  | stal<br>steel<br>сталь  |
| PB-D-KPL300A  | 300   |   |  |   |   |   |
| PB-D-KPL350A  | 350   |   |  |   |   |   |
| PB-D-KPL400A  | 400   |   |  |   |   |   |
| PB-D-KPL450A  | 450   |   |  |   |   |   |
| PB-D-KPL500A  | 500   |   |  |   |   |   |
| PB-D-KPL550A  | 550   |   |  |   |   |   |
| PB-D-KPL250A1   | 250   |   |  |   |   |   |
| PB-D-KPL300A1   | 300   |   |  |   |   |   |
| PB-D-KPL350A1   | 350   |   |  |   |   |   |
| PB-D-KPL400A1   | 400   |   |  |   |   |   |
| PB-D-KPL450A1   | 450   |   |  |   |   |   |
| PB-D-KPL500A1   | 500   |   |  |   |   |   |
| PB-D-KPL550A1   | 550   |   |  |   |   |   |
| PB-D-P20250A  | 250   |   |  |   |   |   |
| PB-D-P20300A  | 300   |   |  |   |   |   |
| PB-D-P20350A  | 350   |   |  |   |   |   |
| PB-D-P20400A  | 400   |   |  |   |   |   |
| PB-D-P20450A  | 450   |   |  |   |   |   |
| PB-D-P20500A  | 500   |   |  |   |   |   |
|   |   | push to open  |  | szary<br>gray<br>серый  |   |   |



### Modern Box

Komplet szuflady średniej B  
Medium drawer set B  
Средний ящик B

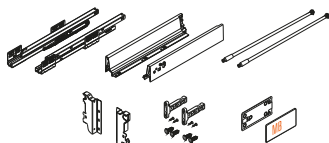

|               |     |            |    |                         |                          |                        |  |
|---------------|-----|------------|----|-------------------------|--------------------------|------------------------|--|
| PB-D-KPL250B  | 250 | soft close | 40 | szary<br>gray<br>серый  | lakier<br>lacquer<br>лак | stal<br>steel<br>сталь |  |
| PB-D-KPL300B  | 300 |            |    |                         |                          |                        |  |
| PB-D-KPL350B  | 350 |            |    |                         |                          |                        |  |
| PB-D-KPL400B  | 400 |            |    |                         |                          |                        |  |
| PB-D-KPL450B  | 450 |            |    |                         |                          |                        |  |
| PB-D-KPL500B  | 500 |            |    |                         |                          |                        |  |
| PB-D-KPL550B  | 550 |            |    |                         |                          |                        |  |
| PB-D-KPL250B1 | 250 |            |    | biały<br>white<br>белый |                          |                        |  |
| PB-D-KPL300B1 | 300 |            |    |                         |                          |                        |  |
| PB-D-KPL350B1 | 350 |            |    |                         |                          |                        |  |
| PB-D-KPL400B1 | 400 |            |    |                         |                          |                        |  |
| PB-D-KPL450B1 | 450 |            |    |                         |                          |                        |  |
| PB-D-KPL500B1 | 500 |            |    |                         |                          |                        |  |
| PB-D-KPL550B1 | 550 |            |    |                         |                          |                        |  |

### Modern Box

Komplet szuflady wysokiej C  
High drawer set C  
Высокий ящик C

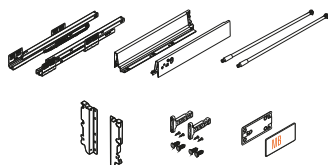







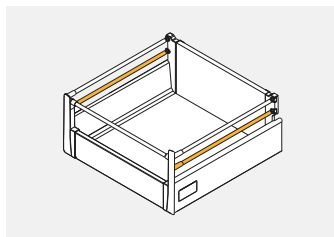

|               |     |              |    |                         |                          |                        |  |
|---------------|-----|--------------|----|-------------------------|--------------------------|------------------------|--|
| PB-D-KPL250C  | 250 | soft close   | 40 | szary<br>gray<br>серый  | lakier<br>lacquer<br>лак | stal<br>steel<br>сталь |  |
| PB-D-KPL300C  | 300 |              |    |                         |                          |                        |  |
| PB-D-KPL350C  | 350 |              |    |                         |                          |                        |  |
| PB-D-KPL400C  | 400 |              |    |                         |                          |                        |  |
| PB-D-KPL450C  | 450 |              |    |                         |                          |                        |  |
| PB-D-KPL500C  | 500 |              |    |                         |                          |                        |  |
| PB-D-KPL550C  | 550 |              |    |                         |                          |                        |  |
| PB-D-KPL250C1 | 250 |              |    | biały<br>white<br>белый |                          |                        |  |
| PB-D-KPL300C1 | 300 |              |    |                         |                          |                        |  |
| PB-D-KPL350C1 | 350 |              |    |                         |                          |                        |  |
| PB-D-KPL400C1 | 400 |              |    |                         |                          |                        |  |
| PB-D-KPL450C1 | 450 |              |    |                         |                          |                        |  |
| PB-D-KPL500C1 | 500 |              |    |                         |                          |                        |  |
| PB-D-KPL550C1 | 550 |              |    |                         |                          |                        |  |
| PB-D-P20300C  | 300 | push to open |    | szary<br>gray<br>серый  |                          |                        |  |
| PB-D-P20350C  | 350 |              |    |                         |                          |                        |  |
| PB-D-P20400C  | 400 |              |    |                         |                          |                        |  |
| PB-D-P20450C  | 450 |              |    |                         |                          |                        |  |
| PB-D-P20500C  | 500 |              |    |                         |                          |                        |  |
| PB-D-P20550C  | 550 |              |    |                         |                          |                        |  |



Reлинг wzdużny  
Longitudinal rail  
Продольный рейлинг







|  |  L<br>mm |  |  |
|---|---|---|---|
| PB-D-REL2500  | 250   | szary<br>gray<br>серый  | stal<br>steel<br>сталь  |
| PB-D-REL3000  | 300   |   |   |
| PB-D-REL3500  | 350   |   |   |
| PB-D-REL4000  | 400   |   |   |
| PB-D-REL4500  | 450   |   |   |
| PB-D-REL5000  | 500   |   |   |
| PB-D-REL5500  | 550   |   |   |

|  |  L<br>mm |  |  |
|---|---|---|---|
| PB-D-REL300-10  | 300   | biały<br>white<br>белый   | stal<br>steel<br>сталь  |
| PB-D-REL350-10  | 350   |   |   |
| PB-D-REL400-10  | 400   |   |   |
| PB-D-REL450-10  | 450   |   |   |
| PB-D-REL500-10  | 500   |   |   |
| PB-D-REL550-10  | 500   |   |   |
| PB-D-REL550-10  | 550   |   |   |

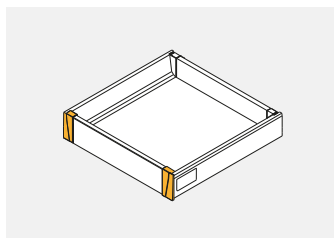

Złączka frontu wewnętrznego, niska  
Inner front connector, low  
Соединитель передней панели, низкий



|  |  |  |  |
|---|---|---|---|
| PB-D-WEWMOCA  | szuflada niska A<br>low drawer A<br>низкий ящик A                                   | szary / gray / серый  | tworzywo<br>plastic<br>пластмасса   |
| PB-D-WEWMOCA1   |   | biały / white / белый   |   |



Złączka frontu wewnętrznego, średnia  
 Inner drawer connector, medium  
 Соединитель передней панели, средний

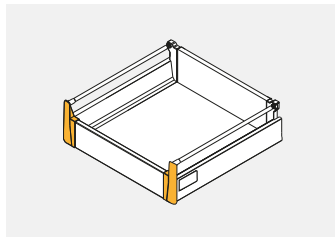

|               |   |                       |                                   |
|---------------|---|-----------------------|-----------------------------------|
| PB-D-WEWMOCB  | szuflada średnia B<br>medium drawer B<br>средний ящик B | szary / gray / серый  | tworzywo<br>plastic<br>пластмасса |
| PB-D-WEWMOCB1 |   | biały / white / белый |                                   |



Złączka frontu wewnętrznego, wysoka, do 1 kompletu relingów  
 Inner drawer connector high, for 1 set of rails  
 Соединитель передней панели, высокий, для 1 комплекта релингов

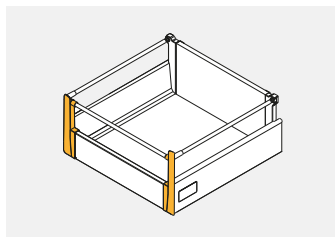





|                  |   |                       |                                   |
|------------------|---|-----------------------|-----------------------------------|
| PB-D-WEWSZKLC    | szuflada wysoka C, 1 reling<br>high drawer C, 1 rail<br>высокий ящик C, рейлинг - 1 шт. | szary / gray / серый  | tworzywo<br>plastic<br>пластмасса |
| PB-D-WEWSZKLC-10 |   | biały / white / белый |                                   |

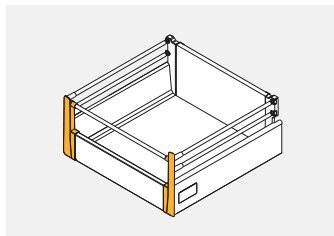

Złączka frontu wewnętrznego, wysoka, do 2 kompletów relingów  
 Inner drawer front connector, high, for 2 sets of rails  
 Соединитель передней панели, высокий, для 2 комплектов рельгов







|   |   |   |   |
|---|---|---|---|
|  |  |  |  |
| PB-D-WEWMOCC  | szuflada wysoka C, 2 relingi<br>high drawer C, 2 rails                            | szary / gray / серый  | tworzywo<br>plastic   |
| PB-D-WEWMOCC1   | wysoki jasek C, reling -2 szt.  | biały / white / белый   | пластмасса  |

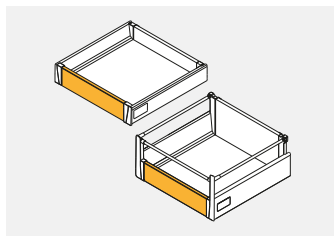

Zestaw do szuflady wewnętrznej wysokiej  
 Set for high inside drawer  
 Набор для внутреннего высокого ящика







|   |   |   |   |
|---|---|---|---|
|  |  |  |  |
| PB-D-ZESWEW-C   | 1100  | szary / gray / серый  | aluminium   |
| PB-D-ZESWEW-C-10  |   | biały / white / белый   | aluminium<br>алюминий   |

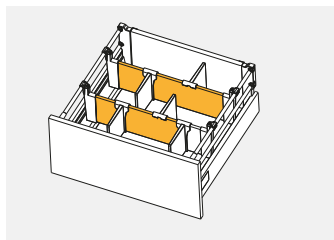

Zestaw do organizacji szuflady wewnętrznej  
Set for inside drawer organization  
Комплект для внутренней организации ящиков







|  |  L<br>mm |  |  |
|---|---|---|---|
| PB-D-WEWORG-A   | 1100  | szary / gray / серый  | aluminium<br>aluminium<br>алюминий  |
| PB-D-WEWORG-A-10  |   | biały / white / белый   |   |
| PB-D-WEWORG-B   |   | szary / gray / серый  |   |
| PB-D-WEWORG-B-10  |   | biały / white / белый   |   |

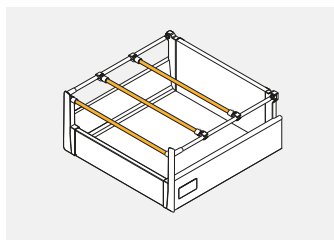

Reling poprzeczny  
Transverse rail  
Поперечный рейлинг



|  |  L<br>mm |  |  |
|---|---|---|---|
| PB-D-RP-1100  | 1100  | szary / gray / серый  | stal<br>steel<br>сталь  |
| PB-D-RP-1100-10   |   | biały / white / белый   |   |



Łącznik relingu poprzecznego  
 Transverse rail connector  
 Соединитель поперечного рейлинга

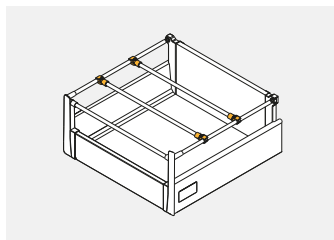

|   |   |   |   |
|---|---|---|---|
|  |  |  |  |
| PB-D-ZR-00-0  | 1 kpl. = 2 szt.<br>1 set = 2 pcs<br>1 комп. = 2 шт.                               | szary / gray / серый  | tworzywo<br>plastic<br>пластмасса   |
| PB-D-ZR-00-10   |   | biały / white / белый   |   |



Uchwyt do szuflady wewnętrznej  
 Inner drawer handle  
 Ручка для внутреннего ящика

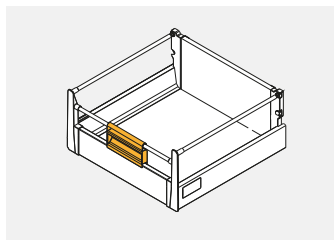

|   |   |   |
|---|---|---|
|  |  |  |
| PB-D-UCHWEW   | szary / gray / серый  | tworzywo<br>plastic<br>пластмасса   |
| PB-D-UCHWEW-10  | biały / white / белый   |   |



Łącznik krzyżowy do relingu  
 Cross rail connector  
 Крестообразный соединитель рейлингов

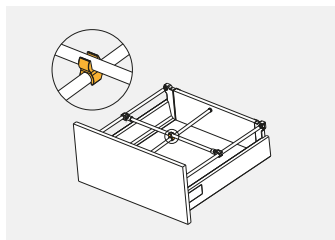

|   |   |   |
|---|---|---|
|  |  |  |
| PB-D-LR-00-0  | szary / gray / серый  | tworzywo<br>plastic<br>пластмасса   |
| PB-D-LR-00-10   | biały / white / белый   |   |



Zaślepka do relingu poprzecznego  
 End cap for transverse rail  
 Заглушка для поперечного рейлинга

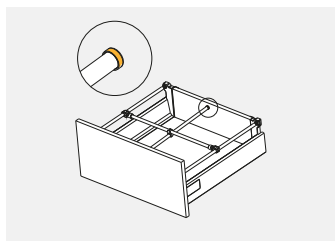





|   |   |   |
|---|---|---|
|  |  |  |
| PB-D-RELCOV   | szary / gray / серый  | tworzywo<br>plastic<br>пластмасса   |
| PB-D-RELCOV-10  | biały / white / белый   |   |

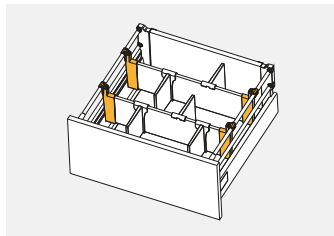

Złączka listwy poprzecznej do relingu  
 Connector for transverse rail and bar  
 Соединитель поперечных планок и рейлингов







|   |   |   |   |
|---|---|---|---|
|  |  |  |  |
| PB-D-CONREL   | 1 kpl. = 2 szt.<br>1 set = 2 pcs  | szary / gray / серый  | tworzywo<br>plastic   |
| PB-D-CONREL-10  | 1 комп. = 2 шт.   | biały / white / белый   | пластмасса  |

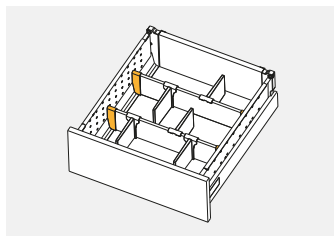

Złączka listwy poprzecznej do boku perforowanego  
 Transverse bar connector for perforated sides  
 Соединитель поперечных планок и перфорированных боковин



|   |   |   |   |
|---|---|---|---|
|  |  |  |  |
| PB-D-CONBXSID   | 1 kpl. = 2 szt.<br>1 set = 2 pcs  | szary / gray / серый  | tworzywo<br>plastic   |
| PB-D-CONBXSIDE-10   | 1 комп. = 2 шт.   | biały / white / белый   | пластмасса  |



Przegroda listwy poprzecznej  
 Transverse bar divider  
 Перегородка для поперечной планки

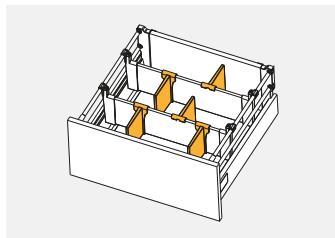

|                 |                       |                                   |
|-----------------|-----------------------|-----------------------------------|
| PB-D-PRZEGLP    | szary / gray / серый  | tworzywo<br>plastic<br>пластмасса |
| PB-D-PRZEGLP-10 | biały / white / белый |                                   |



Bok perforowany do szuflady średniej  
 Perforated side for medium drawer  
 Перфорированная боковина, низкая

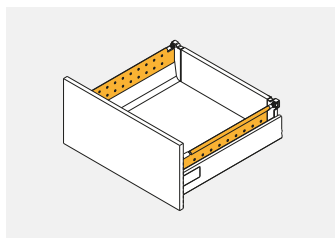





|                   |     |                       |                        |
|-------------------|-----|-----------------------|------------------------|
| PB-D-BXSIDE45B    | 450 | szary / gray / серый  | stal<br>steel<br>сталь |
| PB-D-BXSIDE45B-10 |     | biały / white / белый |                        |
| PB-D-BXSIDE50B    | 500 | szary / gray / серый  |                        |
| PB-D-BXSIDE50B-10 |     | biały / white / белый |                        |



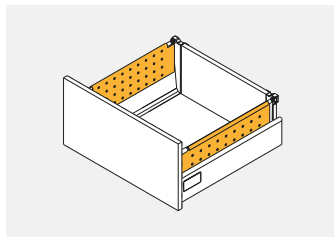
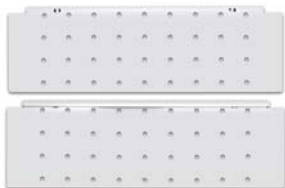

Bok perforowany do szuflady wysokiej  
 Perforated side for high drawer  
 Перфорированная боковина, высокая







|  |  L<br>mm |  |  |
|---|---|---|---|
| PB-D-BXSIDE45C  | 450   | szary / gray / серый  | stal<br>steel<br>сталь  |
| PB-D-BXSIDE45C-10   |   | biały / white / белый   |   |
| PB-D-BXSIDE50C  | 500   | szary / gray / серый  |   |
| PB-D-BXSIDE50C-10   |   | biały / white / белый   |   |

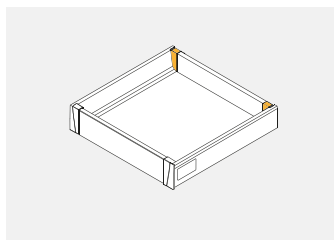

Złączka ścianki tylnej, niska  
 Back panel connector, low  
 Соединитель задней стенки, низкий







|  |  |  |  |
|---|---|---|---|
| PB-D-N2R0-00  | 1 kpl. = L+P  | szary / gray / серый  | stal<br>steel<br>сталь  |
| PB-D-N2R0-01  | 1 set = L+R<br>1 комп. = Л+П  | biały / white / белый   |   |

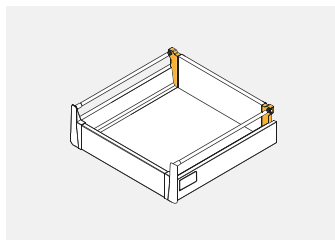

Złączka ścianki tylnej, średnia  
 Back panel connector, medium  
 Соединитель задней стенки, средний







|   |   |   |   |
|---|---|---|---|
|  |  |  |  |
| PB-D-S2R0-00  | 1 kpl. = L+P<br>1 set = L+R   | szary / gray / серый  | stal<br>steel   |
| PB-D-S2R0-01  | 1 комп. = Л+П   | biały / white / белый   | сталь   |

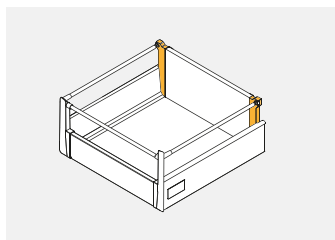

Złączka ścianki tylnej, wysoka  
 Back panel connector, high  
 Соединитель задней стенки, высокий



|   |   |   |   |
|---|---|---|---|
|  |  |  |  |
| PB-D-W2R0-00  | 1 kpl. = L+P<br>1 set = L+R   | szary / gray / серый  | stal<br>steel   |
| PB-D-W2R0-01  | 1 комп. = Л+П   | biały / white / белый   | сталь   |



Mocowanie relingu do podwyższonej ścianki tylnej  
 Back panel connector for rails, additional  
 Соединитель задней стенки для рейлингов, дополнительная

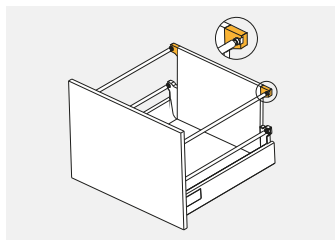





|   |   |   |   |
|---|---|---|---|
|  |  |  |  |
| PB-D-D2R0-00  | 1 kpl. = 2 szt.<br>1 set = 2 pcs  | szary / gray / серый  | tworzywo<br>plastic<br>пластмасса   |
| PB-D-D2R0-01  | 1 комп. = 2 шт.   | biały / white / белый   |   |



Matryca do relingów  
 Marking gauge for rails  
 Матрица для рейлингов



|   |   |   |   |
|---|---|---|---|
|  |  |  |  |
| PB-D-MATRYCA  | 1 kpl. = 1 szt.<br>1 set = 1 pcs<br>1 комп. = 1 шт.                                 | szary<br>gray<br>серый  | tworzywo<br>plastic<br>пластмасса   |



Znacznik do frontów  
 Marking gauge for drawer front  
 Маркер фасада



|              |   |                        |      |
|--------------|---|------------------------|------|
| PB-D-ZNACZ-0 | 1 kpl. = 2 szt.<br>1 set = 2 pcs<br>1 комп. = 2 шт. | szary<br>gray<br>серый | ZnAl |
|--------------|---|------------------------|------|



Mocowanie do relingów  
 Rail mounting  
 Держатель рейлинга



|            |   |                        |                                   |
|------------|---|------------------------|-----------------------------------|
| PB-D-MHG04 | 1 kpl. = 2 szt.<br>1 set = 2 pcs<br>1 комп. = 2 шт. | szary<br>gray<br>серый | tworzywo<br>plastic<br>пластмасса |
|------------|---|------------------------|-----------------------------------|



Rolka stabilizująca do szuflad push to open  
 Drawer stabilizer for push to open drawers  
 Стабилизирующий механизм для ящиков

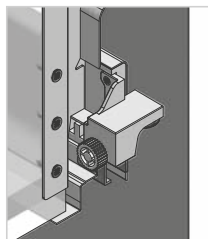

|                |  |                        |                                   |
|----------------|--|------------------------|-----------------------------------|
|                |  |                        |                                   |
| PB-D-MBSTAB-00 | 1 kpl. = L+P<br>1 set = L+R<br>1 комп. = Л+П | szary<br>gray<br>серый | tworzywo<br>plastic<br>пластмасса |



## Modern Box

Komplet szuflady piekarnikowej niskiej  
 Under oven drawer set, low  
 Ящик под духовку, низкий



|                   |     |    |                         |                          |                        |
|-------------------|-----|----|-------------------------|--------------------------|------------------------|
|                   |     |    |                         |                          |                        |
| PB-D-KPL68-450-80 | 450 | 40 | szary<br>gray<br>серый  | lakier<br>lacquer<br>лак | stal<br>steel<br>сталь |
| PB-D-KPL68-500-80 | 500 |    |                         |                          |                        |
| PB-D-KPL68-450-10 | 450 |    | biały<br>white<br>белый |                          |                        |
| PB-D-KPL68-500-10 | 500 |    |                         |                          |                        |

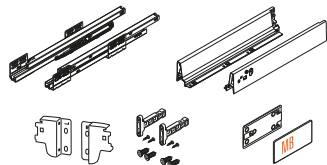

### Modern Box

Komplet szuflady zlewozmywakowej niskiej  
Under sink drawer – set  
Ящик под мойку

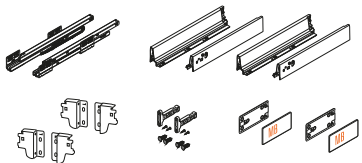

|              |     |    |                        |                          |                        |
|--------------|-----|----|------------------------|--------------------------|------------------------|
|              |     |    |                        |                          |                        |
| PB-D-ZLE-450 | 450 | 40 | szary<br>gray<br>серый | lakier<br>lacquer<br>лак | stal<br>steel<br>сталь |
| PB-D-ZLE-500 | 500 |    |                        |                          |                        |

### Modern Box

Komplet szuflady zlewozmywakowej U, niskiej  
Under sink drawer U, low – set  
Ящик под мойку U, низкий – компоненты

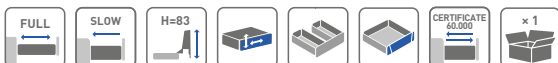
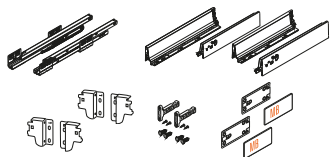

|              |     |    |                        |                          |                        |
|--------------|-----|----|------------------------|--------------------------|------------------------|
|              |     |    |                        |                          |                        |
| PB-D-ULE-500 | 500 | 40 | szary<br>gray<br>серый | lakier<br>lacquer<br>лак | stal<br>steel<br>сталь |

Szablon do szuflad AXIS PRO i MODERN BOX  
 Template for AXIS PRO and MODERN BOX drawers  
 Шаблон для ящиков AXIS PRO и MODERN BOX

NEW

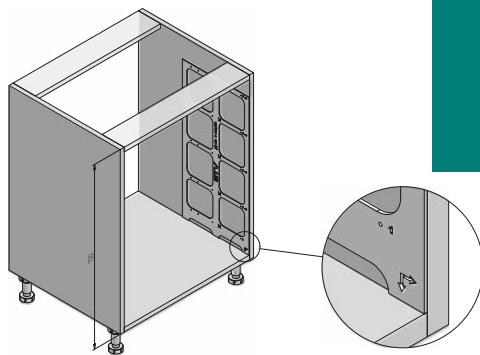
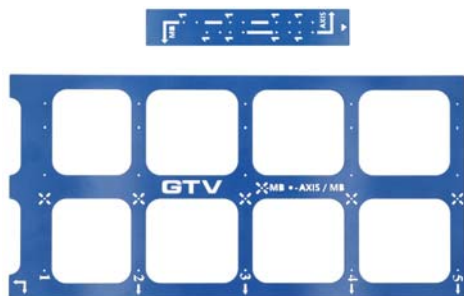

|   |   |
|---|---|
|  |  |
| PB-SZABLON-AXIS-MB  | stal<br>steel<br>сталь  |

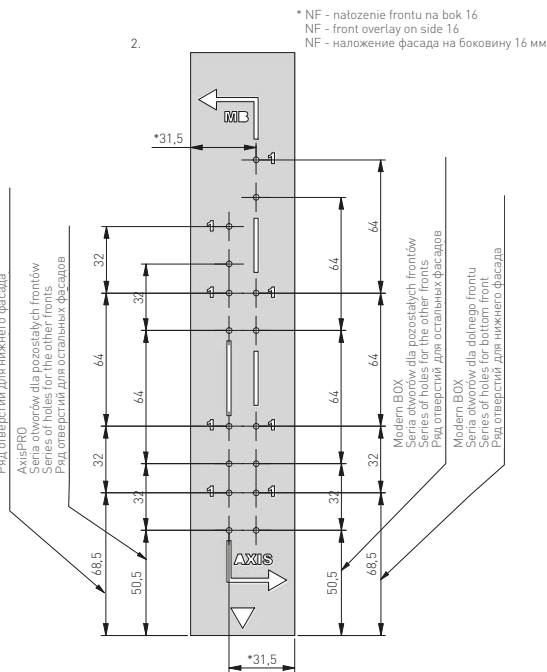
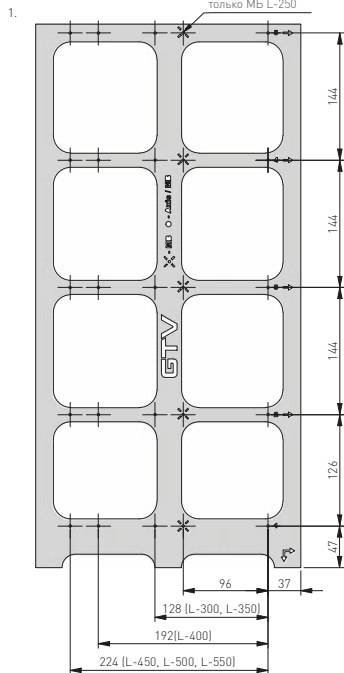

- Szablon do AxisPro i MB (sz. standardowa H=720)  
 Template for front H=140 and H=284 (MB, AxisPro)  
 Шаблон к Axis PRO и MB (стандартная выс. H=720)
- Szablon do frontu H=140 oraz H=284 (MB, AxisPro) Uniwersalny  
 Template for front H=140 and H=284 (MB, AxisPro) Uniwersalny  
 Шаблон для фасада H= 140 и H= 284 (MB, AxisPro) Универсальный

Wkład CUSTOMI A regulowany  
Adjustable cutlery organizer CUSTOMI A  
Лоток CUSTOMI A с возможностью регулировки

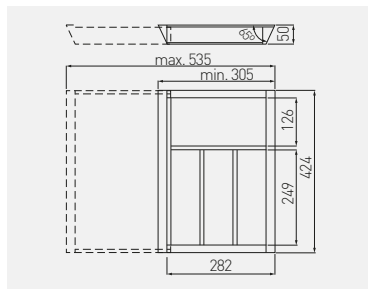

Do szuflad Modern Box i Axis PRO L = 450 mm  
For Modern Box or Axis PRO L = 450 mm  
Подходит для ящиков Modern Box/Axis PRO L = 450 мм

Maksymalny wysuw = 535 mm  
Maximum extension = 535 mm  
Максимальное выдвижение = 535 мм

|   |   |   |   |   |
|---|---|---|---|---|
|  |  |  |  |  |
| W-CUSTOMI-60L450  | 424 x 305   | lakier bezbarwny matowy<br>clearcoat matt surface<br>лак матовый бесцветный       | buk<br>beech<br>бук   | drewno buk<br>beech wood<br>дерево бука   |



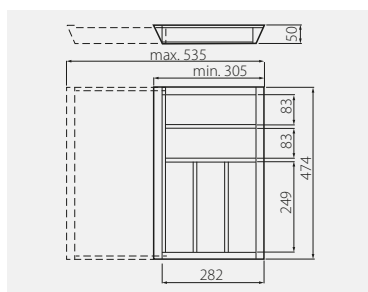

Wkład CUSTOMI BIS A regulowany  
Adjustable cutlery organizer CUSTOMI BIS A  
Лоток CUSTOMI BIS A с возможностью регулировки



Do szuflad Modern Box i Axis PRO L = 500 mm  
For Modern Box or Axis PRO L = 500 mm  
Подходит для ящиков Modern Box/Axis PRO L = 500 мм

Maksymalny wysuw = 535 mm  
Maximum extension = 535 mm  
Максимальное выдвижение = 535 мм

|   |   |   |   |   |
|---|---|---|---|---|
|  |  |  |  |  |
| W-CUSTOMI-60L500  | 474 x 305   | lakier bezbarwny matowy<br>clearcoat matt surface<br>лак матовый бесцветный         | buk<br>beech<br>бук   | drewno buk<br>beech wood<br>дерево бука   |





Wkład CUSTOMI B regulowany  
Adjustable cutlery organizer CUSTOMI B  
Лоток CUSTOMI B с возможностью регулировки

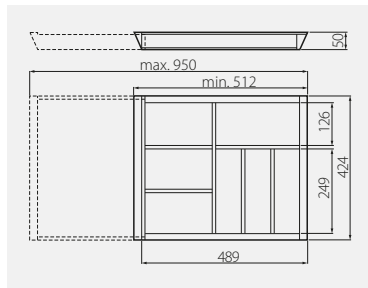

Do szuflad Modern Box i Axis PRO L = 450 mm  
For Modern Box or Axis PRO L = 450 mm  
Подходит для ящиков Modern Box/Axis PRO L = 450 mm

Maksymalny wysuw = 950 mm  
Maximum extension = 950 mm  
Максимальное выдвижение = 950 mm

|   |   |   |   |   |
|---|---|---|---|---|
|  |  |  |  |  |
| W-CUSTOMI-80L450  | 512 x 424   | lakier bezbarwny matowy<br>clearcoat matt surface<br>лак матовый бесцветный       | buk<br>beech<br>бук   | drewno buk<br>beech wood<br>дерево бука   |



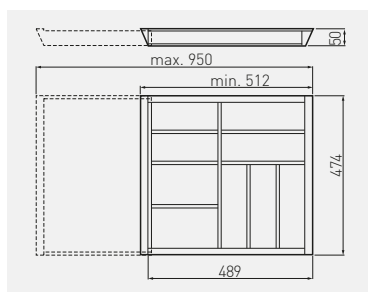

Wkład CUSTOMI BIS B regulowany  
Adjustable cutlery organizer CUSTOMI BIS B  
Лоток CUSTOMI BIS B с возможностью регулировки



Do szuflad Modern Box i Axis PRO L = 500 mm  
For Modern Box or Axis PRO L = 500 mm  
Подходит для ящиков Modern Box/Axis PRO L = 500 mm

Maksymalny wysuw = 950 mm  
Maximum extension = 950 mm  
Максимальное выдвижение = 950 mm





|   |   |   |   |   |
|---|---|---|---|---|
|  |  |  |  |  |
| W-CUSTOMI-80L500  | 512 x 474   | lakier bezbarwny matowy<br>clearcoat matt surface<br>лак матовый бесцветный         | buk<br>beech<br>бук   | drewno buk<br>beech wood<br>дерево бука   |

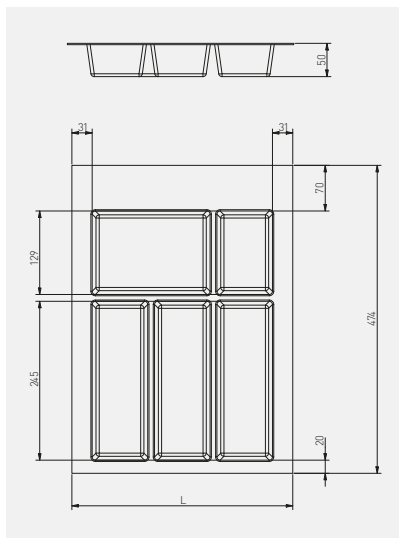

Wkład do szuflad Axispace  
Cutlery organizer Axispace  
Лоток в ящик Axispace

NEW







|                 |  mm |  mm |  |  |
|-----------------|--|--|---|---|
| WK-SZ-AS-400-10 | 282-340  | 400  | biały<br>white<br>белый   | tworzywo<br>plastic<br>пластмасса   |
| WK-SZ-AS-500-10 | 382-440  | 500  |   |   |
| WK-SZ-AS-600-10 | 482-540  | 600  |   |   |
| WK-SZ-AS-800-10 | 682-740  | 800  |   |   |
| WK-SZ-AS-400-60 | 282-340  | 400  | antracyt<br>anthracite<br>антрацит  |   |
| WK-SZ-AS-500-60 | 382-440  | 500  |   |   |
| WK-SZ-AS-600-60 | 482-540  | 600  |   |   |
| WK-SZ-AS-800-60 | 682-740  | 800  |   |   |
| WK-SZ-AS-900-60 | 782-840  | 900  |   |   |



Mata antypoślizgowa AXISPACE do szuflad  
Anti-slip mat for drawers AXISPACE  
Противоскользящий коврик для ящиков AXISPACE

NEW



|  |  mm |  |  |
|---|--|---|---|
| MA-MATA-1-10  | 5000 x 480   | biały / white / белый   | tworzywo<br>plastic<br>пластмасса   |
| MA-MATA-1-20  |  | czarny / black / чёрный   |   |
| MA-MATA-1-60  |  | antracyt / anthracite / антрацит  |   |



Podpórka PELIKAN mała  
Shelf support PELIKAN small  
Полкодержатель PELIKAN маленький

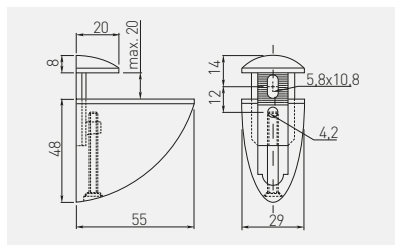

|              |   |      |
|--------------|---|------|
|              |   |      |
| PP-MP0055-01 | chrom / chrome / хром                                 | ZnAl |
| PP-MP0055-02 | satyna / satin / сатин                                |      |
| PP-MP0055-05 | aluminium / aluminium / алюминий                      |      |
| PP-MP0055-06 | stal szcztokowana / brushed steel / шлифованная сталь |      |

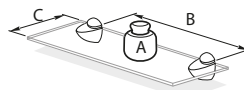

A - max. 8 kg / макс. 8 кг  
B - 40 cm / 40 см  
C - 20 cm / 20 см

Maksymalne obciążenie zależy od ilości wsporników i materiału, z jakiego wykonana jest półka.  
The maximum load depends on the number of supports and material of which the shelf is made.

Максимальная нагрузка зависит от количества кронштейнов и материала, из которого изготовлена полка.

Podpórka PELIKAN średnia  
Shelf support PELIKAN medium  
Полкодержатель PELIKAN средний

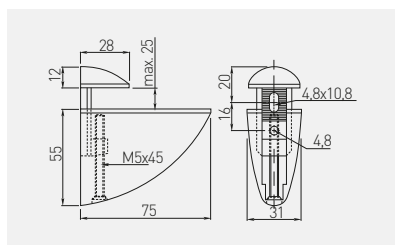

|              |   |      |
|--------------|---|------|
|              |   |      |
| PP-SP0075-01 | chrom / chrome / хром                                 | ZnAl |
| PP-SP0075-02 | satyna / satin / сатин                                |      |
| PP-SP0075-05 | aluminium / aluminium / алюминий                      |      |
| PP-SP0075-06 | stal szcztokowana / brushed steel / шлифованная сталь |      |

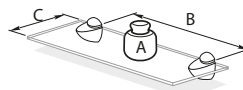

A - max. 10 kg / макс. 10 кг  
B - 50 cm / 50 см  
C - 25 cm / 25 см

Maksymalne obciążenie zależy od ilości wsporników i materiału, z jakiego wykonana jest półka.  
The maximum load depends on the number of supports and material of which the shelf is made.

Максимальная нагрузка зависит от количества кронштейнов и материала, из которого изготовлена полка.

Podpórka PELIKAN duża  
Shelf support PELIKAN large  
Полкодержатель PELIKAN большой

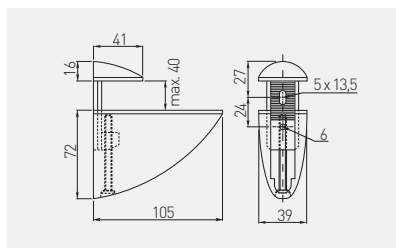

|              |   |      |  |
|--------------|---|------|--|
|              |   |      |  |
| PP-DP0105-01 | chrom / chrome / хром                                 | ZnAl |  |
| PP-DP0105-02 | satyna / satin / сатин                                |      |  |
| PP-DP0105-05 | aluminium / aluminium / алюминий                      |      |  |
| PP-DP0105-06 | stal szorstkowana / brushed steel / шлифованная сталь |      |  |

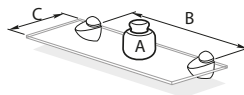

A - max. 12 kg / макс. 12 кг  
B - 60 cm / 60 см  
C - 30 cm / 30 см

Maksymalne obciążenie zależy od ilości wsporników i materiału, z jakiego wykonana jest półka.  
The maximum load depends on the number of supports and material of which the shelf is made.

Максимальная нагрузка зависит от количества кронштейнов и материала, из которого изготовлена полка.

Podpórka GS02  
Shelf support GS02  
Полкодержатель GS02

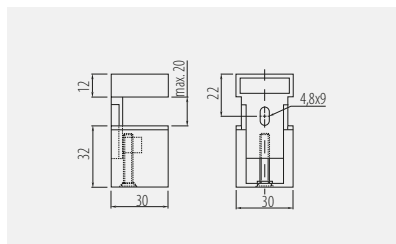

|              |   |      |  |
|--------------|---|------|--|
|              |   |      |  |
| PP-00GS02-01 | chrom / chrome / хром                                 | ZnAl |  |
| PP-00GS02-02 | satyna / satin / сатин                                |      |  |
| PP-00GS02-05 | aluminium / aluminium / алюминий                      |      |  |
| PP-00GS02-06 | stal szorstkowana / brushed steel / шлифованная сталь |      |  |

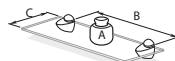

A - max. 4 kg / макс. 4 кг  
B - 40 cm / см  
C - 20 cm / см

Maksymalne obciążenie zależy od ilości wsporników i materiału, z jakiego wykonana jest półka.  
The maximum load depends on the number of supports and material of which the shelf is made.

Максимальная нагрузка зависит от количества кронштейнов и материала, из которого изготовлена полка.

## Podpórka GS03 Shelf support GS03 Полкодержатель GS03

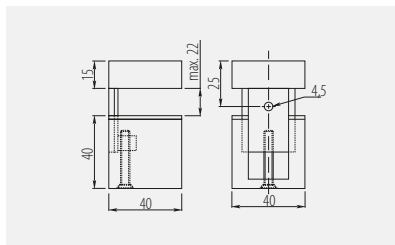

|              |   |      |
|--------------|---|------|
| PP-00GS03-01 | chrom / chrome / хром                                 | ZnAl |
| PP-00GS03-02 | satyna / satin / сатин                                |      |
| PP-00GS03-05 | aluminium / aluminium / алюминий                      |      |
| PP-00GS03-06 | stal szcztokowana / brushed steel / шлифованная сталь |      |

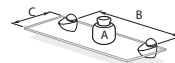

A - max. 6 kg / макс. 6 кг  
B - 50 cm / см  
C - 25 cm / см

Maksymalne obciążenie zależy od ilości wsporników i materiału, z jakiego wykonana jest półka.

The maximum load depends on the number of supports and material of which the shelf is made.

Максимальная нагрузка зависит от количества кронштейнов и материала, из которого изготовлена полка.

## Podpórka GS04 Shelf support GS04 Полкодержатель GS04

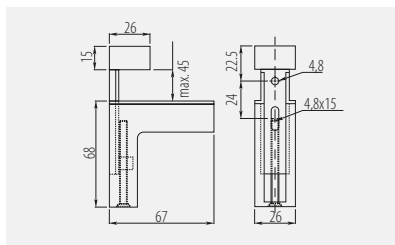

|              |   |      |
|--------------|---|------|
| PP-00GS04-01 | chrom / chrome / хром                                 | ZnAl |
| PP-00GS04-02 | satyna / satin / сатин                                |      |
| PP-00GS04-05 | aluminium / aluminium / алюминий                      |      |
| PP-00GS04-06 | stal szcztokowana / brushed steel / шлифованная сталь |      |

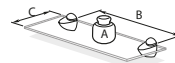

A - max. 10 kg / макс. 10 кг  
B - 60 cm / см  
C - 30 cm / см

Maksymalne obciążenie zależy od ilości wsporników i materiału, z jakiego wykonana jest półka.

The maximum load depends on the number of supports and material of which the shelf is made.

Максимальная нагрузка зависит от количества кронштейнов и материала, из которого изготовлена полка.

Podpórka A48 mocowana na wkręt  
Shelf support A48 screw mounted  
Полкодержатель A48 монтаж на винт

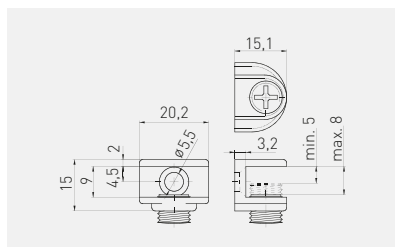

PP-GL-A48-01



chrom / chrome / хром



ZnAl



Podpórka B48 mocowana na wcisk  
Shelf support B48 plug in  
Полкодержатель B48 вставной

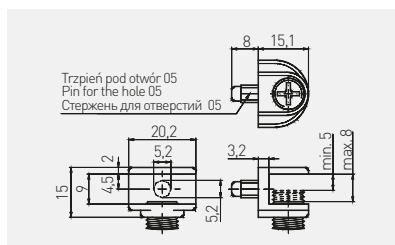

PP-GL-B48-01



chrom / chrome / хром



ZnAl



Podpórka CGP mocowana na wkręt  
Shelf support CGP screw mounted  
Полкодержатель CGP монтаж на винт

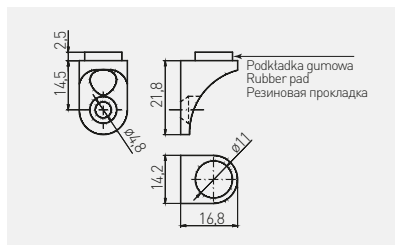

|              |                       |      |
|--------------|-----------------------|------|
|              |                       |      |
| PP-GL-CGP-01 | chrom / chrome / хром | ZnAl |



Podpórka E410 mocowana na wcisk  
Shelf support E410 plug in  
Полкодержатель E410 вставной

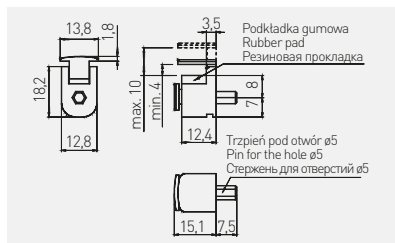

|               |                       |      |
|---------------|-----------------------|------|
|               |                       |      |
| PP-GL-E410-01 | chrom / chrome / хром | ZnAl |





Podpórka SL3  
Shelf support SL3  
Полкодержатель SL3

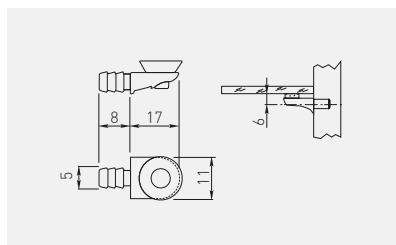

PP-S0L003-01T



chrom / chrome / хром



ZnAl, tworzywo / ZnAl, plastic / ZnAl, пластмасса





Podpórka SL12  
Shelf support SL12  
Полкодержатель SL12

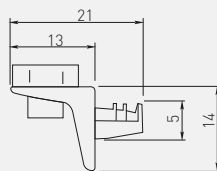

Grubość szkła max. 5 mm  
Glass thickness max. 5 mm  
Толщина стекла макс. 5 мм



PP-S0L012-01T



chrom / chrome / хром



ZnAl, tworzywo / ZnAl, plastic / ZnAl, пластмасса



Podpórka HS0  
Shelf support HS0  
Полкодержатель HS0

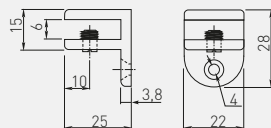

Grubość szkła max. 5 mm  
Glass thickness max. 5 mm  
Толщина стекла макс. 5 мм



PP-HS0006-01



chrom / chrome / хром



ZnAl



Podpórka HS2  
Shelf support HS2  
Полкодержатель HS2

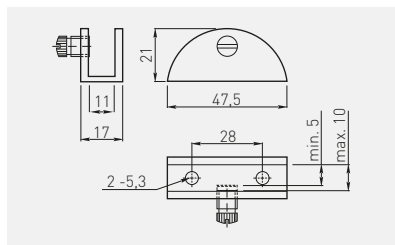

PP-HS2710-01

chrom / chrome / хром

ZnAl



Podpórka J63  
Shelf support J63  
Полкодержатель J63

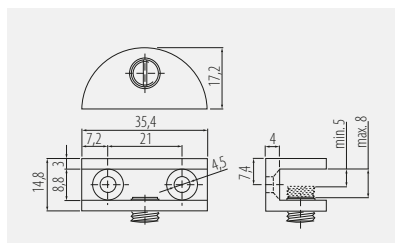

MC-J63-01

chrom / chrome / хром

MC-J63-05



stal szorstkowana / brushed steel / шлифованная сталь

ZnAl

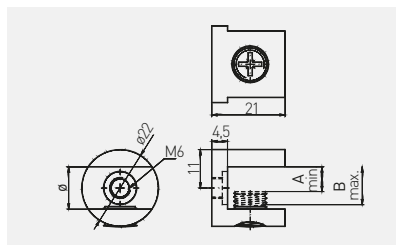

Podpórka J65  
Shelf support J65  
Полкодержатель J65



|  | $\varnothing$<br>mm | A<br>mm | B<br>mm |  |  |
|---|---------------------|---------|---------|---|---|
| MC-J65-08-01  | 8                   | 4       | 8       | chrom / chrome / хром   | ZnAl  |
| MC-J65-08-05  | 8                   | 4       | 8       | stal szorstkowana / brushed steel / шлифованная сталь                             |   |
| MC-J65-10-01  | 10                  | 6       | 10      | chrom / chrome / хром   |   |
| MC-J65-10-05  | 10                  | 6       | 10      | stal szorstkowana / brushed steel / шлифованная сталь                             |   |
| MC-J65-12-01  | 12                  | 7       | 11      | chrom / chrome / хром   |   |
| MC-J65-12-05  | 12                  | 7       | 11      | stal szorstkowana / brushed steel / шлифованная сталь                             |   |



Podpórka J123  
Shelf support J123  
Полкодержатель J123

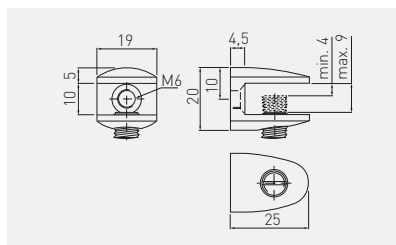

|  |  |  |
|---|---|---|
| MC-J123-01  | chrom / chrome / хром   | ZnAl  |
| MC-J123-05  | stal szorstkowana / brushed steel / шлифованная сталь                               |   |



Podpórka K135  
Shelf support K135  
Полкодержатель K135

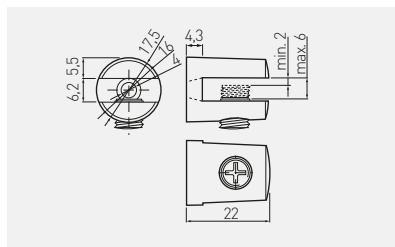

|               |                       |      |
|---------------|-----------------------|------|
|               |                       |      |
| MC-K135-06-01 | chrom / chrome / хром | ZnAl |



Mocowanie J01  
Fixture J01  
Крепление J01

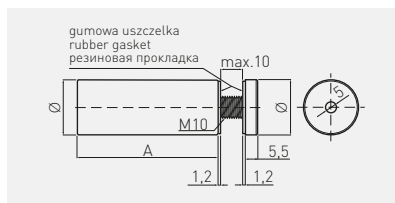





|               | mm | mm   |   |                        |
|---------------|----|------|---|------------------------|
| MC-J01A-12-01 | 12 | 16,5 | chrom / chrome / хром                                 | stal<br>steel<br>сталь |
| MC-J01A-12-06 |    |      | stal szcztokowana / brushed steel / шлифованная сталь |                        |
| MC-J01A-16-01 | 16 | 25   | chrom / chrome / хром                                 |                        |
| MC-J01A-16-06 |    |      | stal szcztokowana / brushed steel / шлифованная сталь |                        |

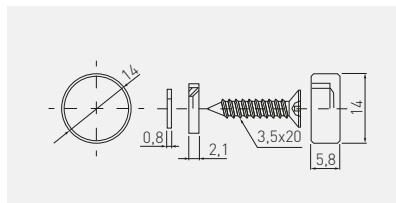

Mocowanie J04  
 Fixture J04  
 Крепление J04



|                |  |  mm |  |  |  |
|----------------|---|--|---|---|---|
| MC-J04A2-14-01 |   | 14   | chrom / chrome / хром   | ZnAl  | 300   |
| MC-J04A2-14-05 |   | 14   | stal szorstkowana / brushed steel / шлифованная сталь                             |   | 200   |
| MC-J04A2-18-01 |   | 18   | chrom / chrome / хром   |   | 100   |
| MC-J04A2-22-01 |   | 22   | chrom / chrome / хром   |   |   |



Mocowanie J60  
 Fixture J60  
 Крепление J60

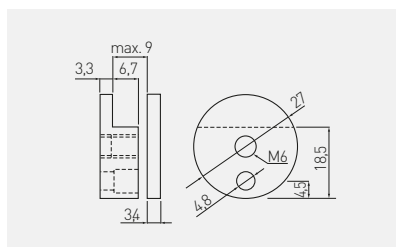

|              |  |  |  |
|--------------|---|---|---|
| MC-J60A27-01 |   | chrom / chrome / хром   | ZnAl  |



Mocowanie J62  
 Fixture J62  
 Крепление J62

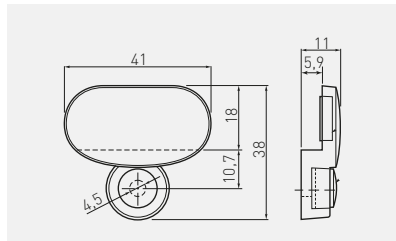

|   |   |   |
|---|---|---|
|  |  |  |
| MC-J62-01   | chrom / chrome / хром   | ZnAl  |



Podpórka GL  
 Shelf support GL  
 Полкодержатель GL

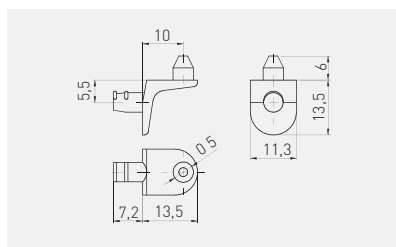

|   |   |   |
|---|---|---|
|  |  |  |
| PP-GL-DR5-01  | chrom / chrome / хром   | ZnAl  |



Podpórka SAFETY  
Shelf support SAFETY  
Полкодержатель SAFETY

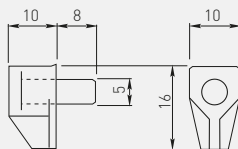

|              |  |   |
|--------------|--|---|
|              |  |   |
| PP-SPL001-01 | przeźroczysty<br>transparent<br>прозрачный | stal, tworzywo<br>steel, plastic<br>сталь, пластмасса |



Podpórka MR-11  
Shelf support pin MR-11  
Полкодержатель MR-11

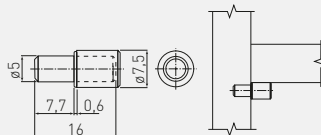

|              |   |                       |                      |
|--------------|---|-----------------------|----------------------|
|              |   |                       |                      |
| MR-ZSL011-01 | z nakładką<br>with plastic coating<br>с накладкой       | chrom / chrome / хром | stal / steel / сталь |
| MR-TDL011-01 | bez nakładki<br>without plastic coating<br>без накладки |                       |                      |



Podpórka SMART  
Shelf support SMART  
Полкодержатель SMART

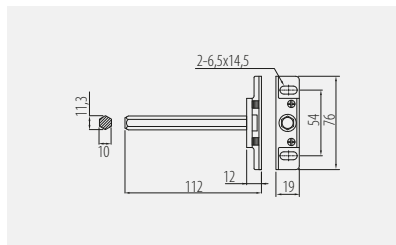

PP-SMART-000

srebrny / silver / серебристый

stal / steel / сталь



Podpórka CLEAR  
Shelf support CLEAR  
Полкодержатель CLEAR

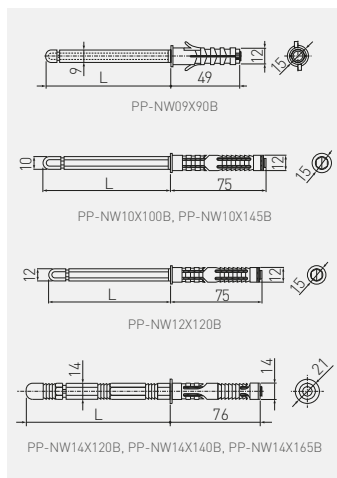

|              | mm | mm  | kg |                             |                        |     |
|--------------|----|-----|----|-----------------------------|------------------------|-----|
| PP-NW09X90B  | 9  | 90  | 10 | brąz<br>brown<br>коричневый | stal<br>steel<br>сталь | 200 |
| PP-NW10X100B | 10 | 110 | 15 |                             |                        |     |
| PP-NW10X145B | 10 | 145 | 15 |                             |                        |     |
| PP-NW12X120B | 12 | 120 | 15 |                             |                        |     |
| PP-NW14X120B | 14 | 120 | 25 |                             |                        |     |
| PP-NW14X140B | 14 | 140 | 25 |                             |                        |     |
| PP-NW14X165B | 14 | 165 | 25 |                             |                        | 100 |





Podpórka LUK pod półkę  
Shelf support bracket LUK  
Полкодержатель LUK

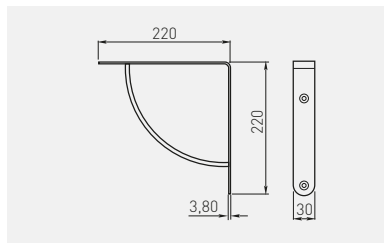

|              |  |             |                                  |                        |
|--------------|--|-------------|----------------------------------|------------------------|
|              |  |             |                                  |                        |
| PP-LUK-00-01 |  | 30 / 2 szt. | chrom / chrome / хром            | stal<br>steel<br>сталь |
| PP-LUK-00-02 |  | 30 / 2 pcs  | satyna / satin / сатин           |                        |
| PP-LUK-00-05 |  | 30 / 2 шт.  | aluminium / aluminium / алюминий |                        |



Podpórka WB-24 pod półkę  
Shelf support bracket WB-24  
Полкодержатель WB-24

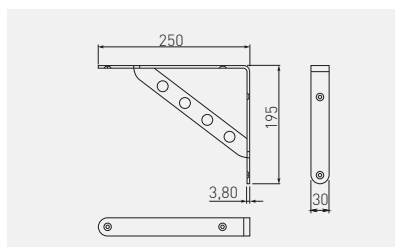

|              |  |             |   |                      |
|--------------|--|-------------|---|----------------------|
|              |  |             |   |                      |
| WB-073024-01 |  | 30 / 2 szt. | chrom / chrome / хром                                 | stal / steel / сталь |
| WB-073024-06 |  | 30 / 2 pcs  | stal szcztokowana / brushed steel / шлифованная сталь |                      |



Podpórka WB-25 pod półkę  
Shelf support bracket WB-25  
Полкодержатель WB-25

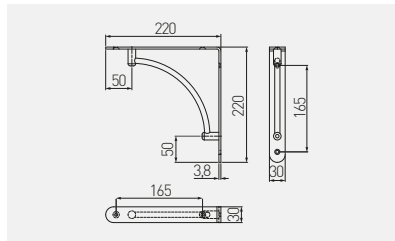

|              |                           |   |                      |
|--------------|---------------------------|---|----------------------|
|              |                           |   |                      |
| WB-073025-01 | 30 / 2 szt.<br>30 / 2 pcs | chrom / chrome / хром                                 | stal / steel / сталь |
| WB-073025-06 | 30 / 2 шт.                | stal szcztokowana / brushed steel / шлифованная сталь |                      |



Podpórka WB-26 pod półkę  
Shelf support bracket WB-26  
Полкодержатель WB-26

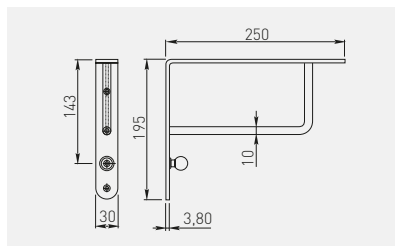

|              |                           |   |                      |
|--------------|---------------------------|---|----------------------|
|              |                           |   |                      |
| WB-073026-01 | 30 / 2 szt.<br>30 / 2 pcs | chrom / chrome / хром                                 | stal / steel / сталь |
| WB-073026-06 | 30 / 2 шт.                | stal szcztokowana / brushed steel / шлифованная сталь |                      |



Podpórka WS12  
Shelf support bracket WS12  
Полкодержатель WS12

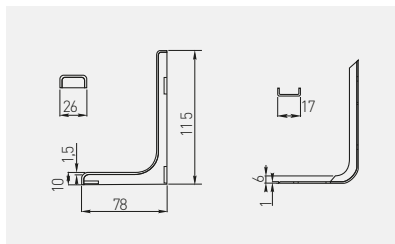

|   |  |   |   |   |
|---|--|---|---|---|
|  | <br>L<br>mm | <br>kg |  |  |
| WB-WS-12-010  | 120  | 8 / 2 szt.<br>8 / 2 pcs<br>8 / 2 шт.  | biały / white / белый   | tworzywo<br>plastic<br>пластмасса   |



Podpórka WS18  
Shelf support bracket WS18  
Полкодержатель WS18

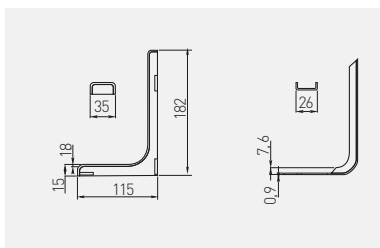

|   |  |   |   |   |
|---|--|---|---|---|
|  | <br>L<br>mm | <br>kg |  |  |
| WB-WS-18-010  | 180  | 9,5 / 2 szt.<br>9,5 / 2 pcs<br>9,5 / 2 шт.  | biały / white / белый   | tworzywo<br>plastic<br>пластмасса   |
| WB-WS-18-020  | 180  |   | czarny / black / чёрный   |   |
| WB-WS-18-060  | 180  |   | szary / gray / серый  |   |



Podpórka WS24  
Shelf support bracket WS24  
Полкодержатель WS24

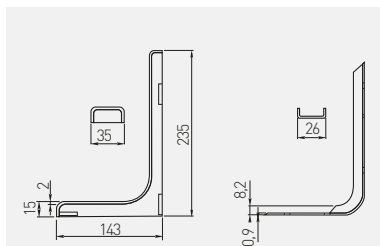

|              |  L<br>mm |  kg |  |  |
|--------------|---|--|---|---|
| WB-WS-24-010 | 240   | 11 / 2 szt.<br>11 / 2 pcs  | biały / white / белый   | tworzywo<br>plastic<br>пластмасса   |
| WB-WS-24-020 | 240   | 11 / 2 szt.<br>11 / 2 pcs  | czarny / black / чёрный   |   |





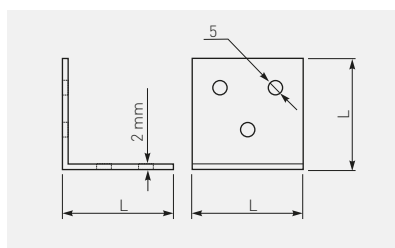



Kątownik FS01 szeroki  
Angle bracket FS01  
Широкий крепежный уголок FS01

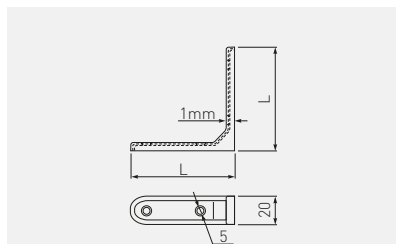

|              |  L<br>mm |  |  |  |
|--------------|---|---|---|---|
| KW-FS0125-01 | 25 x 25 x 24  | chrom / chrome / хром   | stal / steel / сталь  | 1500  |
| KW-FS0140-01 | 40 x 40 x 40  |   |   | 400   |



Kątownik FS03 wzmocniany  
 Angle bracket FS03 reinforced  
 Усиленный крепежный уголок FS03

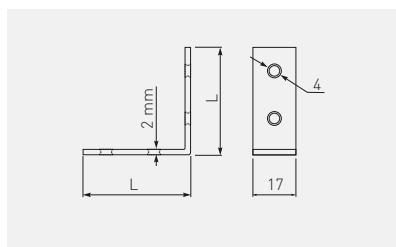

|  |  L<br>mm |  |  |  |
|---|---|---|---|---|
| KW-FS0335-01  | 35 x 35 x 20  | chrom / chrome / хром   | stal / steel / сталь  | 1300  |
| KW-FS0350-01  | 50 x 50 x 20  |   |   | 700   |
| KW-FS0375-01  | 75 x 75 x 20  |   |   | 400   |

Kątownik FS04 standardowy  
 Angle bracket FS04 standard  
 Стандартный крепежный уголок FS04



|  |  L<br>mm |  |  |  |
|---|---|---|---|---|
| KW-FS0425-03  | 25 x 25 x 17  | mosiądz / brass / латунь  | stal / steel / сталь  | 1500  |
| KW-FS0450-03  | 50 x 50 x 17  |   |   | 600   |

Kątownik FS06 narożnikowy  
 Corner bracket FS06  
 Угловой крепежный уголок FS06

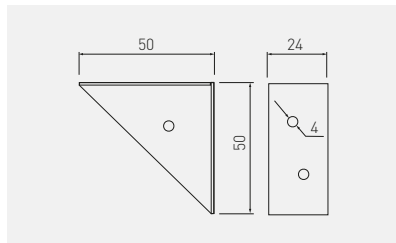

KW-FS0650-01



50 x 50 x 24



chrom / chrome / хром



stal / steel / сталь



Narożnik MONT pojedynczy  
 Corner bracket MONT single  
 Одинарный уголок MONT

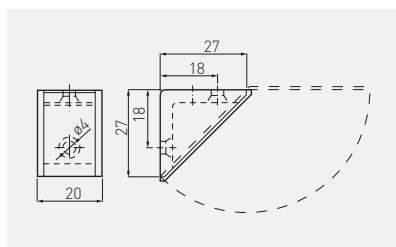

PP-PMONT0M-01\*

biały / white / белый

PP-PMONT0M-07\*

ciemny brąz / dark brown / темно-коричневый

PP-PMONT0M-08\*

szary / gray / серый

PP-PMONT0M-22\*

kość słoniowa / ivory / слоновая кость

tworzywo  
plastic  
пластмасса

\* Produkt dostępny na indywidualne zamówienie / Available for special orders / Товар доступен под заказ

Narożnik MONT podwójny  
 Corner bracket MONT double  
 Двойной уголок MONT

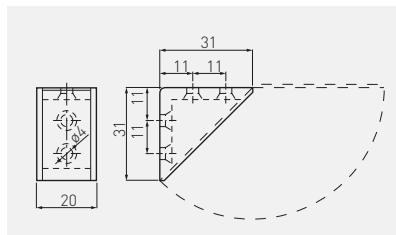

PP-PMONT0D-22\*



kość stoniowa / ivory / слоновая кость

tworzywo  
plastic  
пластмасса

\* Produkt dostępny na indywidualne zamówienie / Available for special orders / Товар доступен под заказ

Narożnik NARS pojedynczy  
 Corner bracket NARS single  
 Одинарный уголок NARS

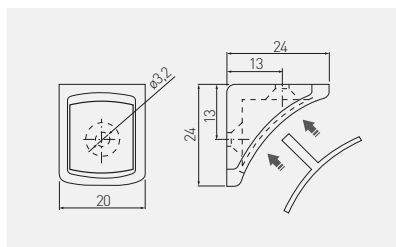

PM-NAR1003-11

kość stoniowa / ivory / слоновая кость



PM-NAR1003-19

szary / gray / серый



PM-NAR1003-10

biały / white / белый

tworzywo  
plastic  
пластмасса

\* Produkt dostępny na indywidualne zamówienie / Available for special orders / Товар доступен под заказ

## Narożnik NARS podwójny

### Corner bracket NARS double

### Двойной уголок NARS

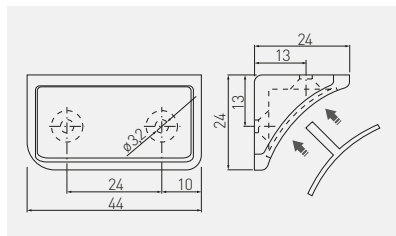

|               |  |                                |
|---------------|--|--------------------------------|
|               |  |                                |
| PM-NAR1004-11 | kość stoniowa / ivory / слоновая кость | tworzywo plastic<br>пластмасса |
| PM-NAR1004-19 | szary / gray / серый                   |                                |
| PM-NAR1004-10 | biały / white / белый                  |                                |



\* Produkt dostępny na indywidualne zamówienie / Available for special orders / Товар доступен под заказ

## Stabilizator ścianki tylnej

### Rear stabilizer

### Стабилизатор задней стенки

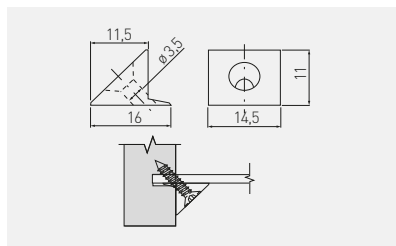

|                |   |  |                                   |
|----------------|---|--|-----------------------------------|
|                |   |  |                                   |
| WZ-SCTYLPR-WK  | z wkrętem 3,5 x 20<br>with screw 3,5 x 20<br>с шурупом 3,5 x 20 | transparentny<br>transparent<br>прозрачный | tworzywo<br>plastic<br>пластмасса |
| WZ-SCTYLPR-BWK | bez wkręta<br>without screw<br>без шурупа                       |  |                                   |





Zawieszka niewidoczna FORCE  
Invisible kitchen hanger FORCE  
Скрытый навес FORCE

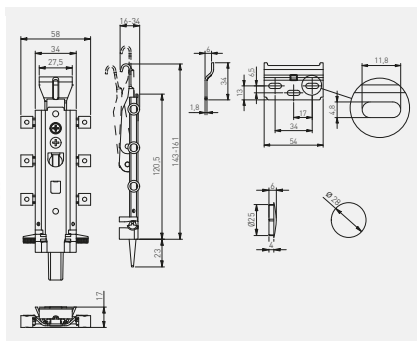

|              |  |                                |  |
|--------------|--|--------------------------------|--|
| ZK-FORCE-KPL | 100 / 2 szt.<br>100 / 2 pcs<br>100 / 2 шт. | srebrny / silver / серебристый | ZnAl, stal / ZnAl, steel / ZnAl, сталь |
|--------------|--|--------------------------------|--|



Zawieszka kuchenna R0 z regulacją  
Kitchen hanger R0 adjustable  
Навес кухонный R0 с регулировкой

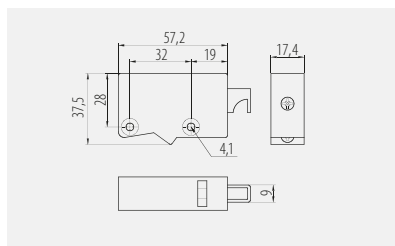



|              |                           |                           |   |
|--------------|---------------------------|---------------------------|---|
| ZK-ZAW-R0-10 | 95 / 2 szt.<br>95 / 2 pcs | biały / white / белый     | stal, tworzywo<br>steel, plastic<br>сталь, пластмасса |
| ZK-ZAW-R0-30 | 95 / 2 шт.                | brąz / brown / коричневый |   |

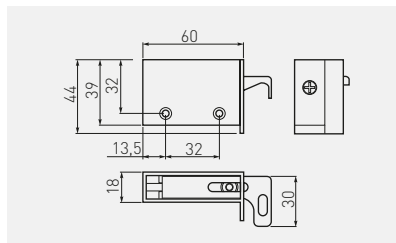

Zawieszka kuchenna R1  
Kitchen hanger R1  
Навес кухонный R1







|   |   |   |   |
|---|---|---|---|
|  |  |  |  |
| ZK-R1-KPL-10  | 110 / 2 szt.<br>110 / 2 pcs<br>110 / 2 шт.  | biały / white / белый   | stal, tworzywo<br>steel, plastic<br>сталь, пластмасса                             |

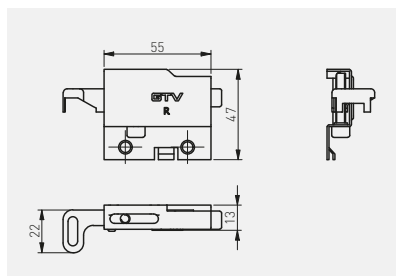

Zawieszka meblowa FORZA  
Cabinet hanger FORZA  
Навес FORZA



|   |   |   |   |   |
|---|---|---|---|---|
|  |  |  |  |  |
| ZK-FORZA-ZAW-KPL  | 150 / 2 szt.<br>150 / 2 pcs<br>150 / 2 шт.  | 1 kpl. = L+P<br>1 set = L+R<br>1 комп. = Л+П  | srebrny<br>silver<br>серебристый  | stal, tworzywo<br>steel, plastic<br>сталь, пластмасса                               |



Zaślepka do zawieszki FORZA  
 Hanger caps FORZA  
 Заглушки для навесов FORZA

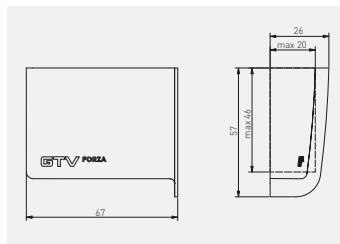

|   |   |   |   |
|---|---|---|---|
|  |  |  |  |
| ZK-FORZA-ZAS-KPL-010  | 1 kpl. = L+P<br>1 set = L+R   | biały / white / белый   | tworzywo<br>plastic<br>пластмасса   |
| ZK-FORZA-ZAS-KPL-020  | 1 комп. = Л+П   | czarny / black / чёрный   |   |



Listwa montażowa  
 Mounting strip  
 Монтажная планка

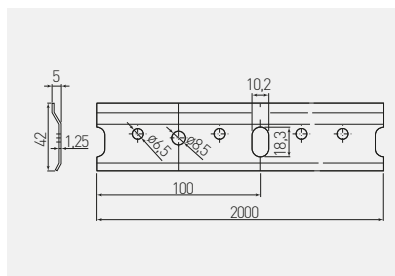

|   |   |   |   |
|---|---|---|---|
|  |  |  |  |
| LO-M2M-00-125   | 2000<br>mm  | osynek<br>galvanized<br>гальваника  | stal<br>steel<br>сталь  |



Złącze do blatów śrubowe  
Concealed worktop connector  
Стяжка для столешниц

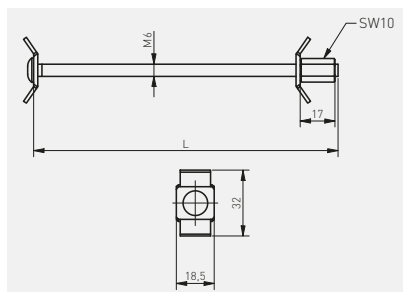

|  |  |  L<br>mm |  |  |
|--|---|---|---|---|
|  | EM-SBL065-01-A  | 65  | chrom / chrome / хром   | stal / steel / сталь  |
|  | EM-SBL100-01-A  | 100   |   |   |
|  | EM-SBL150-01-A  | 150   |   |   |



Złącze mimośrodowe do półek  
Eccentric connecting fitting for shelves  
Эксцентриковая стяжка быстрого монтажа

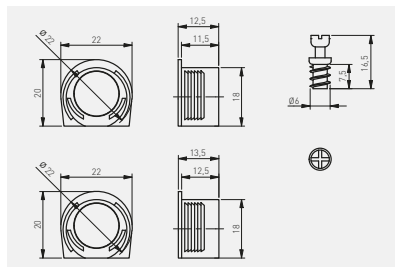

|  |  |  Ø<br>mm |  |  |  |
|--|---|---|---|---|---|
|  | MM-FI20X6X7-PL10-A-1T   | 20  | trzcień 6 x 16,5 mm<br>dowel 6 x 16,5 mm<br>штифт 6 x 16,5 mm                       | biały / white / белый   | ZnAl, tworzywo<br>ZnAl, plastic<br>ZnAl, пластмасса                                 |
|  | MM-FI20X6X7-PL20-A-1T   |   |   | czarny / black / чёрный   |   |
|  | MM-FI20X6X7-PL30-A-1T   |   |   | brąz / brown / коричневый   |   |
|  | MM-FI20X6X7-PL80-A-1T   |   |   | szary / gray / серый  |   |
|  | MM-FI20X6X7-ZN-A-1T   |   |   | srebrny / silver / серебристый  |   |



Szybkozłącze  
Threaded sleeve, with internal thread  
Стяжка межсекционная



SZ-005-00-01T  
SZ-008-00-01T

SZ-005-00-01-AT  
SZ-008-00-01-AT

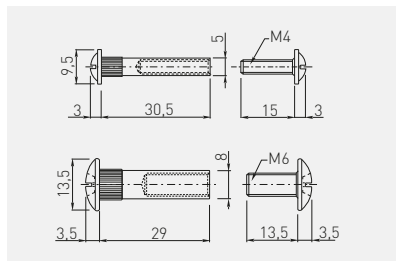







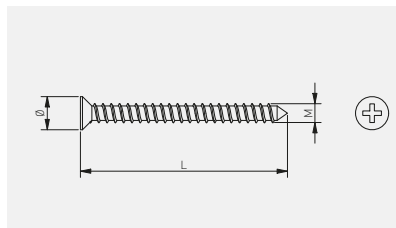



|                 |  |  mm |  |  |
|-----------------|---|--|---|---|
| SZ-005-00-01T   |  | 5  | chrom / chrome / хром   | stal / steel / сталь  |
| SZ-005-00-01-AT |   |  |   |   |
| SZ-008-00-01T   |  | 8  |   |   |
| SZ-008-00-01-AT |   |  |   |   |



Wkręt do drewna  
Screw for wood  
Мебельные шурупы



|               |  |  mm |  |  |  |  mm |  |  |
|---------------|---|--|---|---|---|--|---|---|
| WK-D0320-001* |  | 3 x 20   | chrom<br>chrome<br>хром   | stal<br>steel<br>сталь  |  | 4 x 30   | chrom<br>chrome<br>хром   | stal<br>steel<br>сталь  |
| WK-D0325-001* |   | 3 x 25   |   |   |   | 4 x 40   |   |   |
| WK-D0330-001* | 3 x 30  | 4 x 60   |   |   |   |  |   |   |
| WK-D0416-001  | 4 x 16  | WK-D3516-001   |   |   | 3,5 x 16  |  |   |   |
| WK-D0425-001* | 4 x 25  | WK-D3530-001   | 3,5 x 30  |   |   |  |   |   |

\* Produkt dostępny na indywidualne zamówienie / Available for special orders / Товар доступен под заказ



Mimośród  
Eccentric connecting fitting  
Эксцентрик

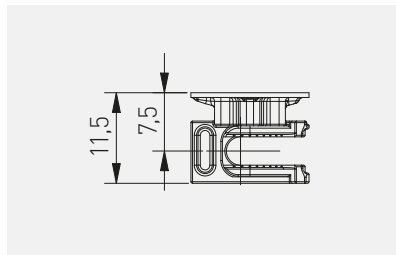

|                 |          |                               |      |
|-----------------|----------|-------------------------------|------|
|                 |          |                               |      |
| WK-CAM-15-12-D  | Ø15 x 12 | srebrny / silver / серебряный | ZnAl |
| WK-CAM-15-13-D* | Ø15 x 13 |                               |      |



\*

Trzpień do mimośrodru  
Bolt for eccentric connecting fitting  
Шток эксцентрика

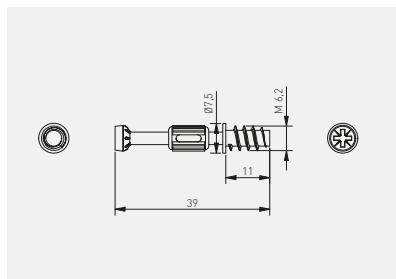

|                |          |  |   |
|----------------|----------|--|---|
|                |          |  |   |
| WK-DOW63X45B-D | 6,3 x 45 | srebrny, czarny<br>silver, black<br>серебряный, чёрный   | stal, tworzywo<br>steel, plastic<br>сталь, пластмасса |
| WK-DOW63X39-D  | 6,3 x 39 | srebrny, czerwony<br>silver, red<br>серебряный, красный  |   |
| WK-DOW63X35B-D | 6,3 x 35 | srebrny, zielony<br>silver, green<br>серебряный, зеленый |   |
| WK-DOW63X31G-D | 6,3 x 31 |  |   |



Komplet mimośród i trzpień  
Set of eccentric connecting fitting and bol  
Комплект эксцентрик и шток



|  |  mm |  |  |
|---|--|---|---|
| WK-CAM-15-DOW63X45-KPL-1T   | 6,3 x 45   | srebrny, czarny<br>silver, black<br>серебряный, чёрный                            | stal, tworzywo, ZnAl<br>steel, plastic, ZnAl<br>сталь, пластмасса, ZnAl           |
| WK-CAM-15-DOW63X39-KPL-1T   | 6,3 x 39   | srebrny, czerwony<br>silver, red<br>серебряный, красный                           |   |
| WK-CAM-15-DOW63X35-KPL-1T   | 6,3 x 35   | srebrny, zielony<br>silver, green<br>серебряный, зелёный                          |   |
| WK-CAM-15-DOW63X31-KPL-1T   | 6,3 x 31   | srebrny, zielony<br>silver, green<br>серебряный, зелёный                          |   |



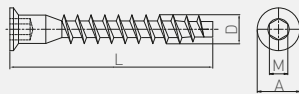

\* Produkt dostępny na indywidualne zamówienie / Available for special orders / Товар доступен под заказ

Konfirmat  
Confirmat screw  
Конфирмат



|              | L        | D  | A   | M   |   |
|--------------|----------|----|-----|-----|---|
| WK-CF6450-01 | 6,4 x 50 | 50 | 6,4 | 9,5 | 4 |
| WK-CF0750-01 | 7 x 50   | 50 | 7   | 10  | 4 |

|  |  |  |
|---|---|---|
| WK-CF6450-01*   | chrom / chrome / хром   | stal / steel / сталь  |
| WK-CF0750-01*   |   |   |



\* Produkt dostępny na indywidualne zamówienie / Available for special orders / Товар доступен под заказ

Magnes MENSA  
Magnetic catch MENSA  
Магнит MENSA

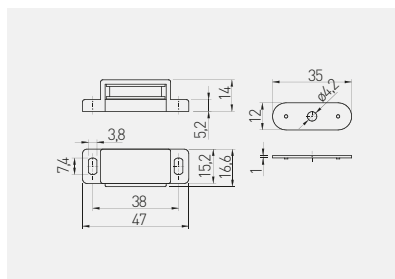



|   |   |   |
|---|---|---|
|  |  |  |
| MG-MENSA-010  | biały / white / белый   | stal, tworzywo<br>steel, plastic  |
| MG-MENSA-030  | brąz / brown / коричневый   | stal, tworzywo<br>steel, plastic  |

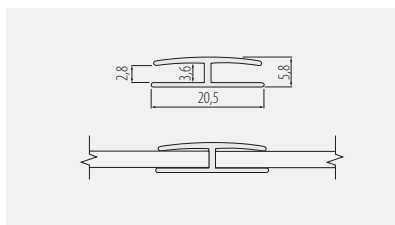

Profil meblowy PFM – typ H  
Furniture edge profile PFM – type H  
Мебельный профиль PFM – тип H



|   |   |   |   |
|---|---|---|---|
|  |  |  |  |
| PM-PFMH51-10*   | 2000  | ciemny brąz / dark brown / темно-коричневый   | tworzywo<br>plastic<br>пластмасса   |
| PM-PFMH61-10*   | 2000  | ciemny mahoń / dark mahogany / темное красное дерево                                |   |
| PM-PFMH50-24*   | 2400  | biały / white / белый   |   |
| PM-PFMH50-25*   | 2500  | biały / white / белый   |   |
| PM-PFMH55-25*   | 2500  | czarny / black / чёрный   |   |
| PM-PFMH64-25*   | 2500  | mahoń / mahogany / красное дерево   |   |





Listwa ozdobna płaska  
Flat decorative strip  
Плоская декоративная планка

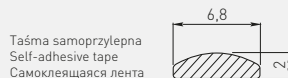

|  |  L<br>mm |  |  |
|---|---|---|---|
| LO-00-00-001*   | 2000  | chrom / chrome / хром   | tworzywo<br>plastic<br>пластмасса   |
| LO-00-00-003  | 2000  | mosiądz / brass / латунь  |   |





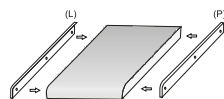

\* Produkt dostępny na indywidualne zamówienie / Available for special orders / Товар доступен под заказ

Listwa boczna 38  
Worktop edging strip 38  
Торцевая планка 38



Do blatów o grubości 38 mm  
For worktops 38 mm thick  
Для столешниц толщиной 38 мм

|  |  |  L<br>mm |  |  |
|---|---|---|---|---|
| LMB-BOCZ38L-05  | lewa / left / левая   | 600   | aluminium / aluminium / алюминий  | aluminium<br>aluminium<br>алюминий  |
| LMB-BOCZ38L-20M   |   |   | czarny / black / чёрный   |   |
| LMB-BOCZ38P-05  | prawa / right / правая  |   | aluminium / aluminium / алюминий  |   |
| LMB-BOCZ38P-20M   |   |   | czarny / black / чёрный   |   |



Listwa kątowa 38  
Worktop angle edging strip 38  
Угловая планка 38

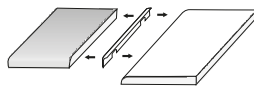

Do blatów o grubości 38 mm  
For worktops 38 mm thick  
Для столешниц толщиной 38 мм

|   |   |   |   |
|---|---|---|---|
|  |  |  |  |
| LMB-KAT38-05  | 600   | aluminium / aluminium / алюминий  | aluminium   |
| LMB-KAT38-20M   |   | czarny / black / чёрный   | aluminium<br>алюминий   |



\* Produkt dostępny na indywidualne zamówienie / Available for special orders / Товар доступен под заказ



Listwa szczelinowa 38 mm  
Worktop joining strip 38 mm  
Щелевая планка 38 mm

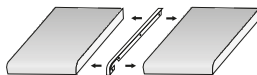

Do blatów o grubości 38 mm  
For worktops 38 mm thick  
Для столешниц толщиной 38 мм

|   |   |   |   |
|---|---|---|---|
|  |  |  |  |
| LMB-SZCZ38-05   | 600   | aluminium / aluminium / алюминий  | aluminium   |
| LMB-SZCZ38-20M  |   | czarny / black / чёрный   | aluminium<br>aluminium<br>алюминий  |



Drażek owalny  
Oval wardrobe rail  
Овальная труба

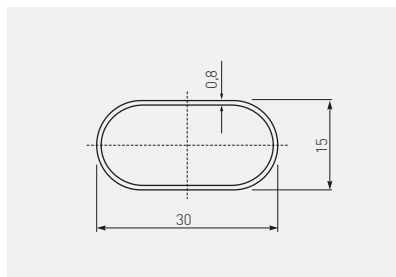

|   |   |   |   |
|---|---|---|---|
|  |  |  |  |
| RR-CH-OW-000  | 3000  | chrom / chrome / хром   | stal / steel / сталь  |



Mocowanie RDR do drążka owalnego  
 RDR mounting bracket for oval wardrobe rail  
 Крепление RDR для овальной трубы

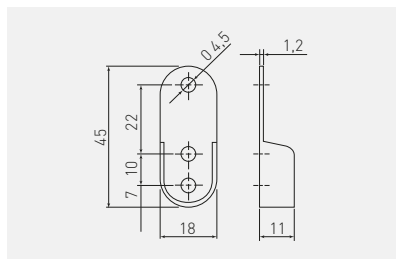

MR-RDR0-0000



chrom / chrome / хром



stal / steel / сталь



Uchwyt WP-28 do rury owalnej  
 WP-28 angle bracket for oval rail  
 Крепление дистанционное для овальной трубы WP-28

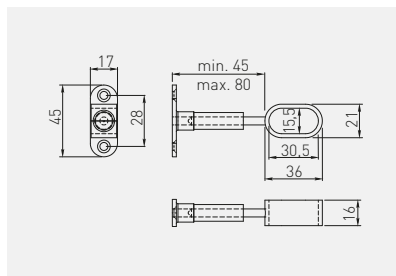

MR-WP-028-01



chrom / chrome / хром





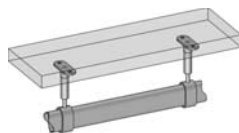



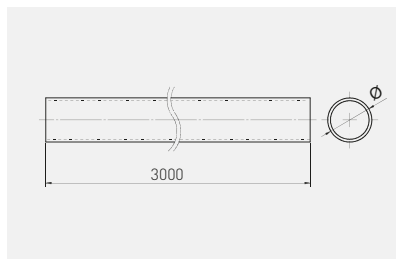



ZnAl



Drążek okrągły  
Round wardrobe rail  
Мебельная штанга



|              |  mm |  mm |  mm |  |  |
|--------------|--|--|--|---|---|
| RR-161030H01 | 16   | 1  | 3000   | chrom<br>chrome<br>хром   | stal<br>steel<br>сталь  |
| RR-161230H01 | 16   | 1,2  |  |   |   |
| RR-250730H01 | 25   | 0,7  |  |   |   |
| RR-250830H01 | 25   | 0,8  |  |   |   |
| RR-250930H01 | 25   | 0,9  |  |   |   |

|               |  mm |  mm |  mm |  |  |
|---------------|--|--|--|---|---|
| RR-251030H01  | 25   | 1  | 3000   | chrom<br>chrome<br>хром   | stal<br>steel<br>сталь  |
| RR-401230H01* | 40   | 1,2  |  |   |   |
| RR-501030H01  | 50   | 1  |  |   |   |
| RR-501230H01  | 50   | 1,2  |  |   |   |



\* Produkt dostępny na indywidualne zamówienie / Available for special orders / Товар доступен под заказ

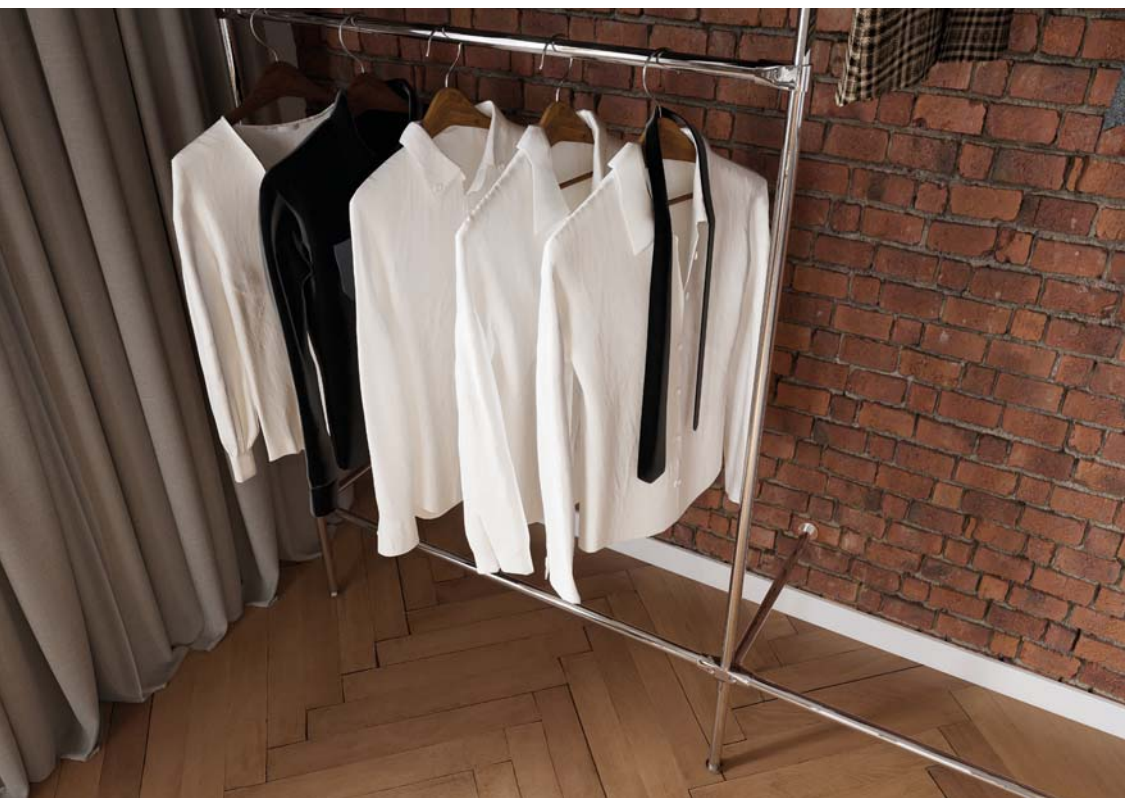

Монтаж R-25 до дрэжка круглого  
R-25 mounting bracket for round rail  
Крепление R-25 для трубы

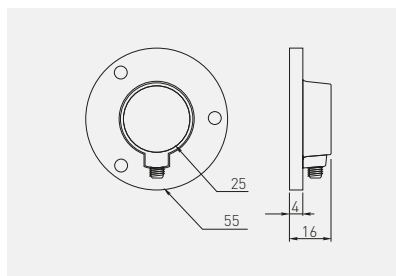

|   |   |   |   |
|---|---|---|---|
|  | <br>mm |  |  |
| MR-RS025-001  | 25  | chrom / chrome / хром   | stal / steel / сталь  |



Монтаж R-50 до дрэжка круглого  
R-50 mounting bracket for round rail  
Крепление R-50 для трубы

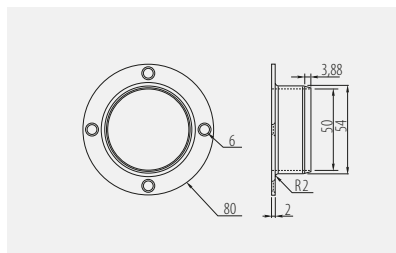

|   |   |   |   |
|---|---|---|---|
|  | <br>mm |  |  |
| MR-R0050-001  | 50  | chrom / chrome / хром   | stal / steel / сталь  |



Mocowanie PZ-2 dolne do drążka okrągłego  
 PZ-2 bottom mounting bracket for round rail  
 Нижнее крепление PZ-2 для трубы

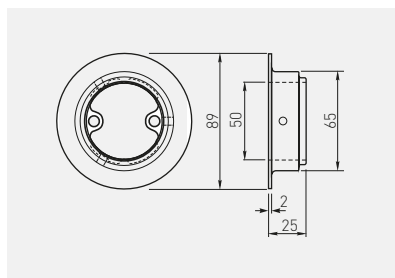

|   |   |   |   |
|---|---|---|---|
|  | <br>mm |  |  |
| MR-WPZ002-01  | 50  | chrom / chrome / хром   | stal / steel / сталь  |



Pierścień mocujący PZ-3  
 Mounting ring PZ-3  
 Крепёжное кольцо PZ-3

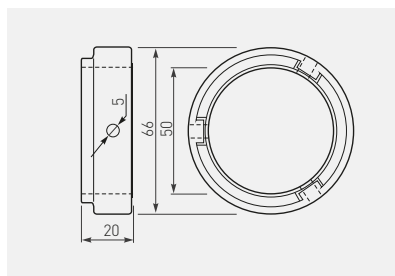

|   |   |   |   |
|---|---|---|---|
|  | <br>mm |  |  |
| MR-WPZ003-01  | 50  | chrom / chrome / хром   | ZnAl  |



Uchwyt WP-10 dystansowy, regulowany  
 WP-10 support bracket, adjustable  
 Регулируемый кронштейн WP-10

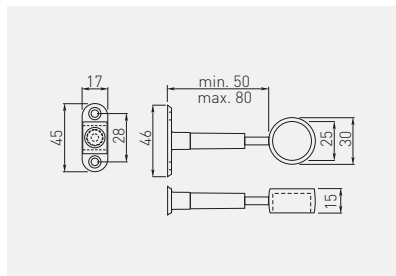

|   |  |   |   |
|---|--|---|---|
|  |  mm |  |  |
| MR-WP-010-01  | 25   | chrom / chrome / хром   | ZnAl  |



Uchwyt WP-11 dystansowy, regulowany z zaślepką  
 WP-11 support bracket, adjustable with cover  
 Регулируемый кронштейн WP-11 с заглушкой

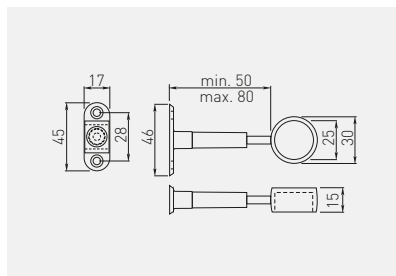

|   |  |   |   |
|---|--|---|---|
|  |  mm |  |  |
| MR-WP-011-01  | 25   | chrom / chrome / хром   | ZnAl  |





Uchwyt THA-12 dystansowy, przelotowy  
 THA-12 support bracket  
 Опорный кронштейн THA-12 сквозной

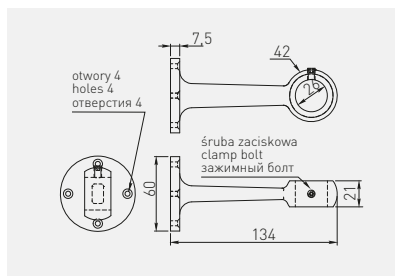

|   |   |   |   |
|---|---|---|---|
|  | <br>mm |  |  |
| MR-THA12-001  | 25  | chrom / chrome / хром   | ZnAl  |



Uchwyt THB-12 dystansowy  
 THB-12 support bracket  
 Опорный кронштейн THB-12

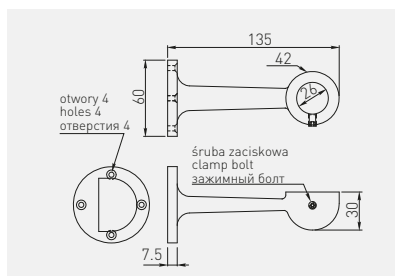

|   |   |   |   |
|---|---|---|---|
|  | <br>mm |  |  |
| MR-THB12-001  | 25  | chrom / chrome / хром   | ZnAl  |



Złącze TH-5 dwuramienne  
 TH-5 connector  
 Муфта TH-5 двухраструбная

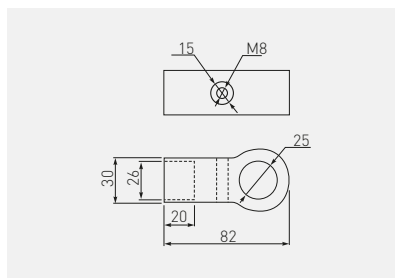

|   |   |   |   |
|---|---|---|---|
|  |  |  |  |
| MR-TH005-001  | 25  | chrom / chrome / хром   | ZnAl  |



Złącze TH-16 dwuramienne  
 TH-16 connector  
 Муфта двухраструбная TH-16

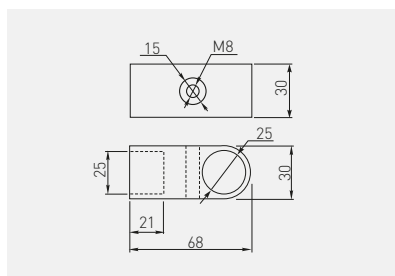

|   |   |   |   |
|---|---|---|---|
|  |  |  |  |
| MR-TH016-001  | 25  | chrom / chrome / хром   | ZnAl  |



Złącze TH-4 dwuramienne typ T  
 TH-4 connector type T  
 Муфта TH-4 двухраструбная тип T

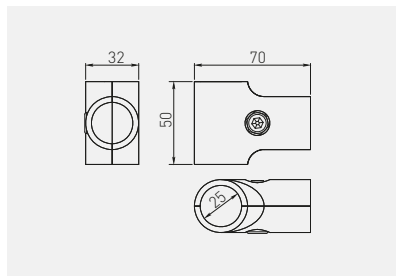

|   |   |   |   |
|---|---|---|---|
|  | <br>mm |  |  |
| MR-TH004-001  | 25  | chrom / chrome / хром   | ZnAl  |



Zestaw złączy TH-18 typ L  
 TH-18 connector type L  
 Набор муфт TH-18 тип L

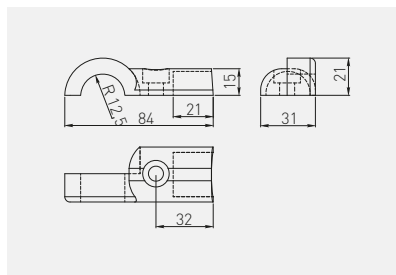

Możliwość uzyskania różnych położeń połączenia  
 The possibility of obtaining various positions of connection  
 Возможность получения разных положений соединения

|   |   |   |   |   |
|---|---|---|---|---|
|  |  | <br>mm |  |  |
| MR-TH018-KPL  | prawy / lewy<br>right / left<br>правый / левый                                      | 25  | chrom / chrome / хром   | ZnAl  |



Złącze TH-9  
TH-9 connector  
Муфта TH-9

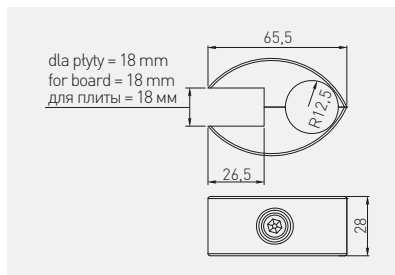

MR-TH009-001



chrom / chrome / хром



ZnAl



Zalecana grubość szkła z użyciem wkładek: 4-8 mm  
Recommended glass thickness with inserts: 4-8 mm  
Рекомендуемая толщина стекла с использованием вкладышей: 4-8 мм



Zestaw złączy TH-35  
TH-35 set of connectors  
Набор муфт TH-35

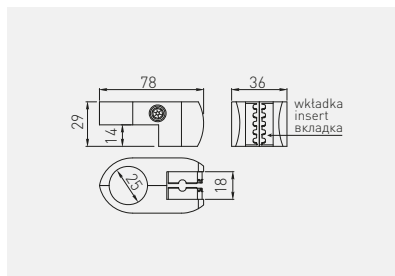

MR-TH035-KPL



25



chrom / chrome / хром



ZnAl



Zalecana grubość szkła z użyciem wkładek: 4-8 mm  
Recommended glass thickness with inserts: 4-8 mm  
Рекомендуемая толщина стекла с использованием вкладышей: 4-8 мм

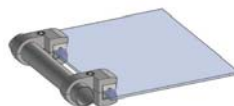

Złącze WP-15  
WP-15 connector  
Муфта WP-15

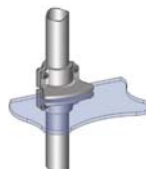
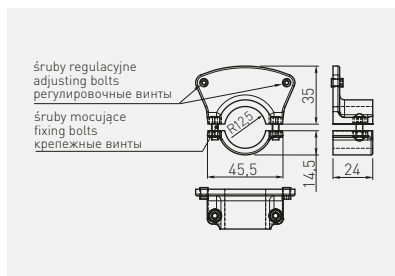

|   |   |   |   |
|---|---|---|---|
|  | <br>mm |  |  |
| MR-WP-15-KPL  | 25  | chrom / chrome / хром   | ZnAl  |



Złącze TH-2 potrójne  
TH-2 connector three-way  
Муфта TH-2 тройная

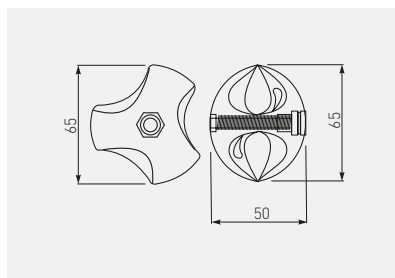

|   |   |   |   |
|---|---|---|---|
|  |  |  |  |
| MR-TH002-L01  | lewy / left / левый   | chrom / chrome / хром   | ZnAl  |
| MR-TH002-P01  | prawy / right / правый  |   |   |



Złącze TH-18 podwójne  
TH-18 double connector  
Муфта TH-18 двойная

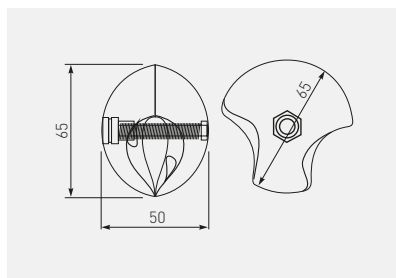

|              |                        |                       |      |
|--------------|------------------------|-----------------------|------|
|              |                        |                       |      |
| MR-TH018-L01 | lewy / left / левый    | chrom / chrome / хром | ZnAl |
| MR-TH018-P01 | prawy / right / правый |                       |      |



Zaślepka okrągła  
Round end cap  
Круглая заглушка

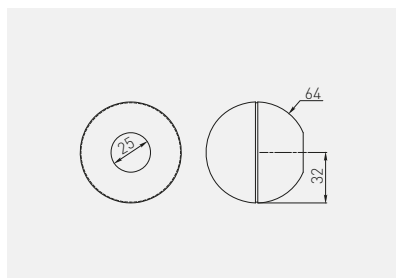

|              |          |                       |      |
|--------------|----------|-----------------------|------|
|              |          |                       |      |
| MR-THQZ1-001 | 25<br>mm | chrom / chrome / хром | ZnAl |



Zaślepka TH-19  
TH-19 end cap  
Заглушка TH-19

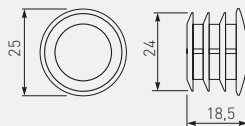

|   |   |   |   |
|---|---|---|---|
|  | <br>mm |  |  |
| MR-TH019-001  | 25  | chrom / chrome / хром   | ZnAl  |



Stopka plastikowa zewnętrzna  
Plastic end cap  
Внешняя ножка, пластмассовая

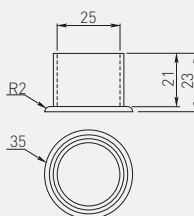

|   |   |   |   |
|---|---|---|---|
|  | <br>mm |  |  |
| MR-TH019-003  | 25  | czarny<br>black<br>чёрный   | tworzywo<br>plastic<br>пластмасса   |



Uchwyt do relingu prosty  
 Rail support  
 Ручка для рейлинга прямая

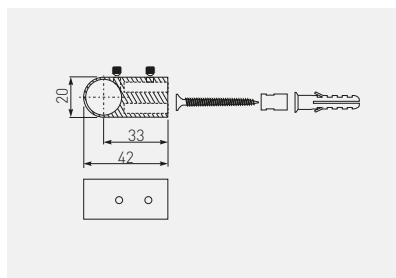

|   |   |   |   |
|---|---|---|---|
|  | <br>mm |  |  |
| MR-WP2802-01  | 16  | chrom / chrome / хром   | ZnAl  |



Zaślepka do relingu prosta  
 End cap  
 Заглушка для рейлинга прямая

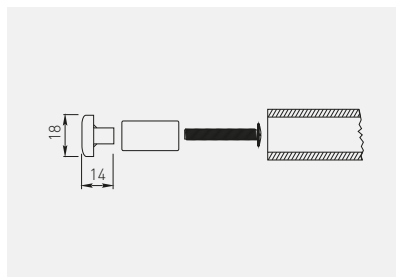

|   |   |   |   |
|---|---|---|---|
|  | <br>mm |  |  |
| MR-WP2815-01  | 16  | chrom / chrome / хром   | ZnAl  |





Uchwyt do relingu  
Rail support  
Ручка для рейлинга

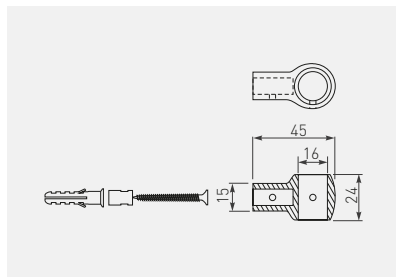

|   |   |   |   |
|---|---|---|---|
|  | <br>mm |  |  |
| MR-WP2804-01  | 16  | chrom / chrome / хром   | ZnAl  |



Zaślepka do relingu  
End cap  
Заглушка для рейлинга

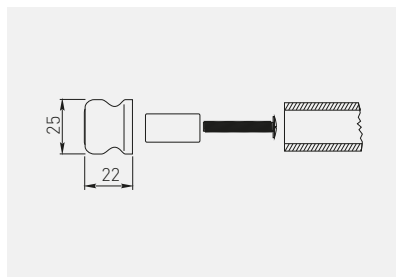

|   |   |   |   |
|---|---|---|---|
|  | <br>mm |  |  |
| MR-WP2806-01  | 16  | chrom / chrome / хром   | ZnAl, tworzywo / ZnAl, plastic / ZnAl, пластмасса                                   |



Łącznik do relingu  
 Rail connector  
 Соединитель для рейлинга

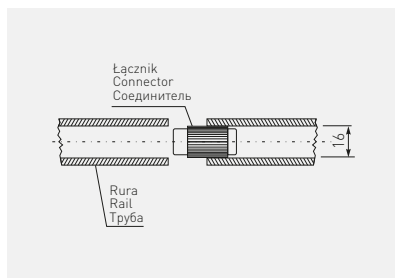

|   |  |   |   |
|---|--|---|---|
|  |  mm |  |  |
| MR-WP2807-20  | 16   | czarny / black / чёрный   | tworzywo / plastic / пластмасса   |



Zaślepka do relingu z gwintem  
 End cap with thread for rails  
 Заглушка для рейлинга с резьбой

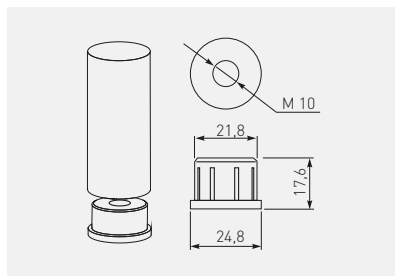

|   |   |   |
|---|---|---|
|  |  |  |
| MR-WP2023-01  | chrom / chrome / хром   | ZnAl  |



Начыкі до релінгу PS1  
 Hooks for rails PS1  
 Крючки для рейлінга PS1

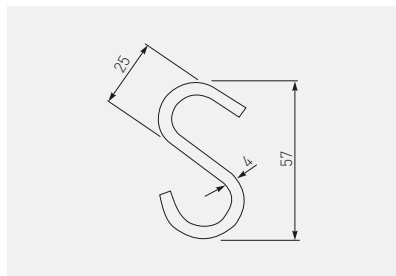

|   |   |   |   |
|---|---|---|---|
|  | <br>mm |  |  |
| MR-WPS01-001  | 16  | chrom / chrome / хром   | stal / steel / сталь  |



Начыкі до релінгу PS3  
 Hooks for rails PS3  
 Крючки для рейлінга PS3

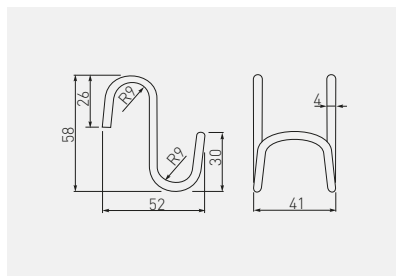





|   |   |   |   |
|---|---|---|---|
|  | <br>mm |  |  |
| MR-WPS03-001  | 16  | chrom / chrome / хром   | stal / steel / сталь  |

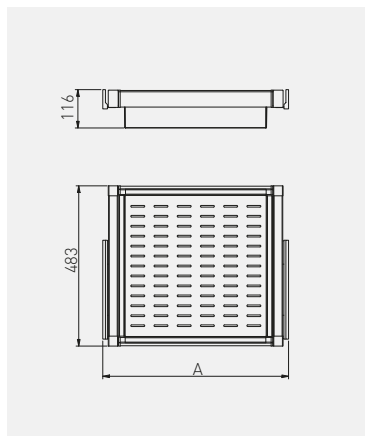

Kosz metalowy ELITE  
Metal basket ELITE  
Металлическая корзина ELITE





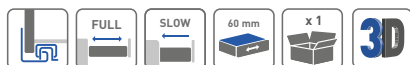

|  | A<br>min./max. |  |  |  |
|---|----------------|---|---|---|
| WG-KOSZM60-10   | 560 - 618      | pełny<br>full<br>полное   | biały<br>white<br>белый   | stal, tworzywo<br>steel, plastic<br>сталь, пластмасса                             |
| WG-KOSZM70-10   | 660 - 718      |   |   |   |
| WG-KOSZM80-10   | 760 - 818      |   |   |   |
| WG-KOSZM90-10   | 860 - 918      |   |   |   |
| WG-KOSZM60-60   | 560 - 618      |   | antracyt<br>anthracite<br>антрацит  |   |
| WG-KOSZM70-60   | 660 - 718      |   |   |   |
| WG-KOSZM80-60   | 760 - 818      |   |   |   |
| WG-KOSZM90-60   | 860 - 918      |   |   |   |

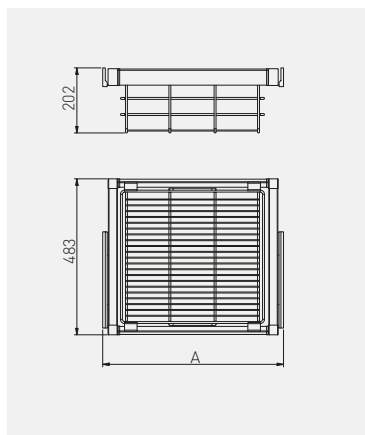

Kosz ażurowy ELITE  
 Openwork basket ELITE  
 Прутяная корзина ELITE





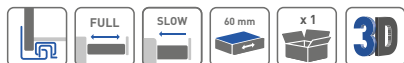

|  | A<br>min./max. |  |  |  |
|---|----------------|---|---|---|
| WG-KOSZ60-10  | 560 - 618      | pełny<br>full<br>полное   | biały<br>white<br>белый   | stal, tworzywo<br>steel, plastic<br>сталь, пластмасса                             |
| WG-KOSZ70-10  | 660 - 718      |   |   |   |
| WG-KOSZ80-10  | 760 - 818      |   |   |   |
| WG-KOSZ90-10  | 860 - 918      |   |   |   |
| WG-KOSZ60-60  | 560 - 618      |   | antracyt<br>anthracite<br>антрацит  |   |
| WG-KOSZ70-60  | 660 - 718      |   |   |   |
| WG-KOSZ80-60  | 760 - 818      |   |   |   |
| WG-KOSZ90-60  | 860 - 918      |   |   |   |

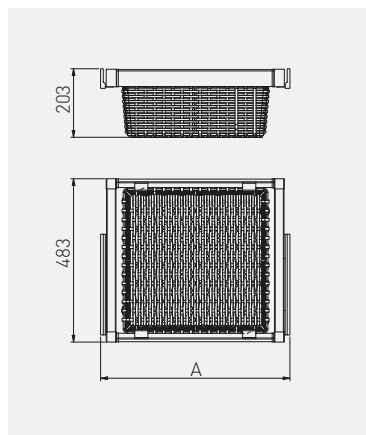

Kosz rattanowy ELITE  
Rattan basket ELITE  
Плетеная из rattana корзина ELITE





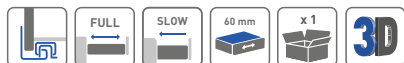

|               |  <b>A</b><br>min./max. |  |  |  |
|---------------|---|---|---|---|
| WG-KOSZR60-10 | 560 – 618   | pełny<br>full<br>полное   | biały<br>white<br>белый   | stal, tworzywo<br>steel, plastic<br>сталь, пластмасса                             |
| WG-KOSZR70-10 | 660 – 718   |   |   |   |
| WG-KOSZR80-10 | 760 – 818   |   |   |   |
| WG-KOSZR90-10 | 860 – 918   |   |   |   |
| WG-KOSZR60-60 | 560 – 618   |   | antracyt<br>anthracite<br>антрацит  |   |
| WG-KOSZR70-60 | 660 – 718   |   |   |   |
| WG-KOSZR80-60 | 760 – 818   |   |   |   |
| WG-KOSZR90-60 | 860 – 918   |   |   |   |

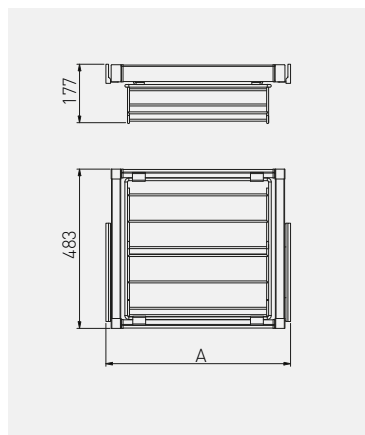

Szuflada ELITE na obuwanie  
 Pull out shoes rack ELITE  
 Полка для обуви ELITE





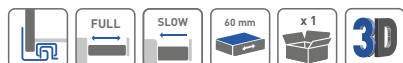

|  | A<br>min./max. |  |  |  |                                    |
|---|----------------|---|---|---|------------------------------------|
| WG-POBUW60-10   | 560 - 618      |  | biały<br>white<br>белый   | stal, tworzywo<br>steel, plastic<br>сталь, пластмасса                             |                                    |
| WG-POBUW70-10   | 660 - 718      |   |   |   |                                    |
| WG-POBUW80-10   | 760 - 818      |   |   |   |                                    |
| WG-POBUW90-10   | 860 - 918      |   |   |   |                                    |
| WG-POBUW60-60   | 560 - 618      |   | pełny<br>full<br>полное   |   | antracyt<br>anthracite<br>антрацит |
| WG-POBUW70-60   | 660 - 718      |   |   |   |                                    |
| WG-POBUW80-60   | 760 - 818      |   |   |   |                                    |
| WG-POBUW90-60   | 860 - 918      |   |   |   |                                    |

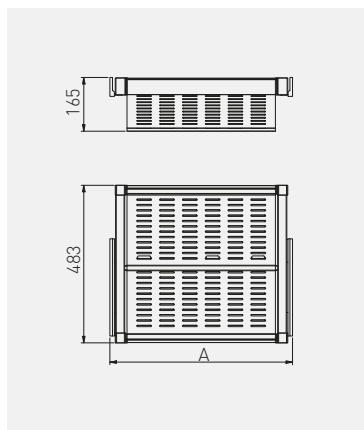

Szublada ELITE na obuwie metalowa  
Metal pull out shoes rack ELITE  
Металлическая полка для обуви ELITE





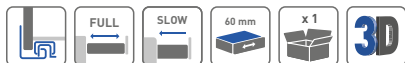

|  | A<br>min./max. |  |  |  |   |
|---|----------------|---|---|---|---|
| WG-POBUWM60-10  | 560 - 618      | pełny<br>full<br>полное   |  | biały<br>white<br>белый   |   |
| WG-POBUWM70-10  | 660 - 718      |   |   |   |   |
| WG-POBUWM80-10  | 760 - 818      |   |   |   |   |
| WG-POBUWM90-10  | 860 - 918      |   |   |   |   |
| WG-POBUWM60-60  | 560 - 618      |   |   | antracyt<br>anthracite<br>антрацит  | stal, tworzywo<br>steel, plastic<br>сталь, пластмасса |
| WG-POBUWM70-60  | 660 - 718      |   |   |   |   |
| WG-POBUWM80-60  | 760 - 818      |   |   |   |   |
| WG-POBUWM90-60  | 860 - 918      |   |   |   |   |



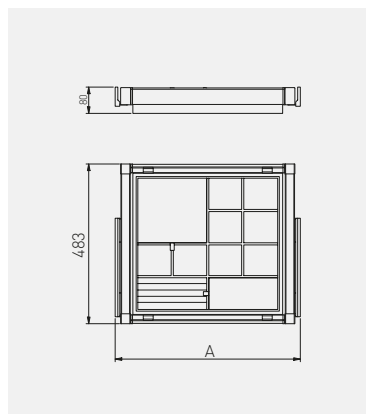

Organizer ELITE  
Organiser ELITE  
Органайзер ELITE



|  | A<br>min./max. |  |  |  |
|---|----------------|---|---|---|
| WG-PRZEG60-10   | 560 – 618      | pełny<br>full<br>полное   | biały<br>white<br>белый   | stal, tworzywo<br>steel, plastic<br>сталь, пластмасса                             |
| WG-PRZEG70-10   | 660 – 718      |   |   |   |
| WG-PRZEG80-10   | 760 – 818      |   |   |   |
| WG-PRZEG90-10   | 860 – 918      |   |   |   |
| WG-PRZEG60-60   | 560 – 618      |   | antracyt<br>anthracite<br>антрацит  |   |
| WG-PRZEG70-60   | 660 – 718      |   |   |   |
| WG-PRZEG80-60   | 760 – 818      |   |   |   |
| WG-PRZEG90-60   | 860 – 918      |   |   |   |



Wieszak ELITE na spodnie  
Wardrobe trouser rack ELITE  
Вешалка для брюк ELITE

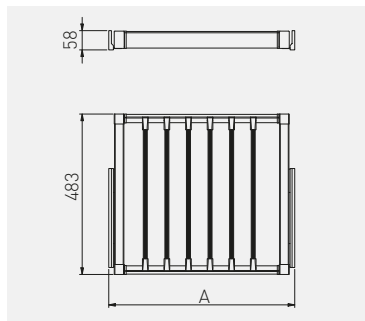

|               | A<br>min./max. |                         |                                    |   |
|---------------|----------------|-------------------------|------------------------------------|---|
| WG-WSPOD60-10 | 560 – 618      | pełny<br>full<br>полное | biały<br>white<br>белый            | stal, tworzywo<br>steel, plastic<br>сталь, пластмасса |
| WG-WSPOD70-10 | 660 – 718      |                         |                                    |   |
| WG-WSPOD80-10 | 760 – 818      |                         |                                    |   |
| WG-WSPOD90-10 | 860 – 918      |                         | antracyt<br>anthracite<br>антрацит |   |
| WG-WSPOD60-60 | 560 – 618      |                         |                                    |   |
| WG-WSPOD70-60 | 660 – 718      |                         |                                    |   |
| WG-WSPOD80-60 | 760 – 818      |                         |                                    |   |
| WG-WSPOD90-60 | 860 – 918      |                         |                                    |   |

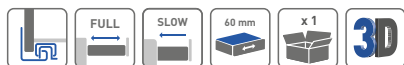



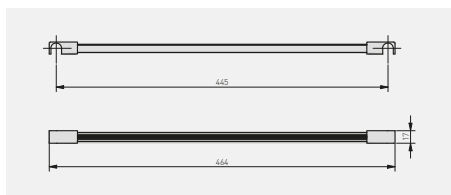

Belka do szuflady ELITE  
ELITE wardrobe drawer bar  
Балка ящика ELITE

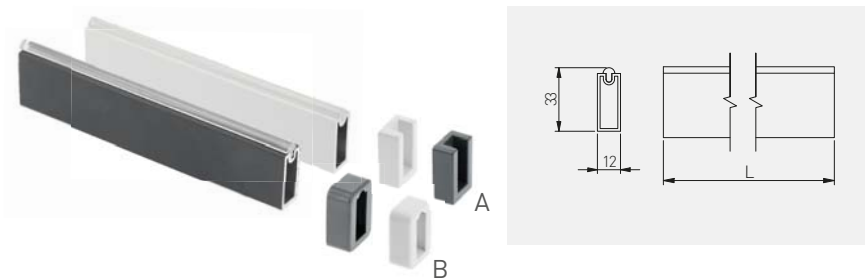

|            | ilość drutów<br>number of wires<br>Количество проводов | dodatkowa belka<br>additional bar<br>Дополнительная балка |   |
|------------|--|---|---|
| WG-WSPOD60 | 6  | WG-WSPOD-BAR-10<br>WG-WSPOD-BAR-60                        | aluminium, tworzywo<br>aluminium, plastic<br>алюминий, пластмасса |
| WG-WSPOD70 | 7  |   |   |
| WG-WSPOD80 | 8  |   |   |
| WG-WSPOD90 | 9  |   |   |

Drażek prostokątny z rozetkami  
 Rectangular wardrobe rail with socket  
 Прямоугольная мебельная штанга







|                |  |  L<br>mm |  |  |
|----------------|---|---|---|---|
| WG-RRPSET-A-10 |   | 3000  | biały<br>white<br>белый   | aluminium, tworzywo<br>aluminium, plastic<br>алюминий, пластмасса                 |
| WG-RRPSET-B-10 |   |   | antracyt<br>anthracite<br>антрацит  |   |
| WG-RRPSET-A-60 |   |   |   |   |
| WG-RRPSET-B-60 |   |   |   |   |

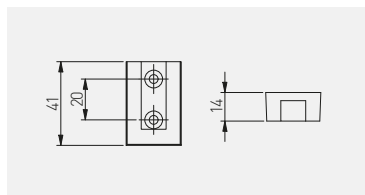

Rozetka prostokątna  
 Rectangular wardrobe rail socket  
 Прямоугольное крепление



|            |  |   |  |  |
|------------|---|--|---|---|
| WG-RDRP-10 |   | rozetka prostokątna z zaślepką<br>rectangular wardrobe rail socket with end cap<br>прямоугольное крепление с заглушкой       | biały<br>white<br>белый   | ZnAl, tworzywo<br>ZnAl, plastic<br>ZnAl, пластмасса                                 |
| WG-RDRP-60 |   |  | antracyt<br>anthracite<br>антрацит  |   |
| WG-RDRO-10 |   | rozetka prostokątna bez zaślepki<br>rectangular wardrobe rail socket without end cap<br>прямоугольное крепление без заглушки | biały<br>white<br>белый   | ZnAl  |
| WG-RDRO-60 |   |  | antracyt<br>anthracite<br>антрацит  |   |



Pantograf z podnośnikiem olejowym  
 Pull-down wardrobe rail – oil  
 Пантограф с масляным подъемником

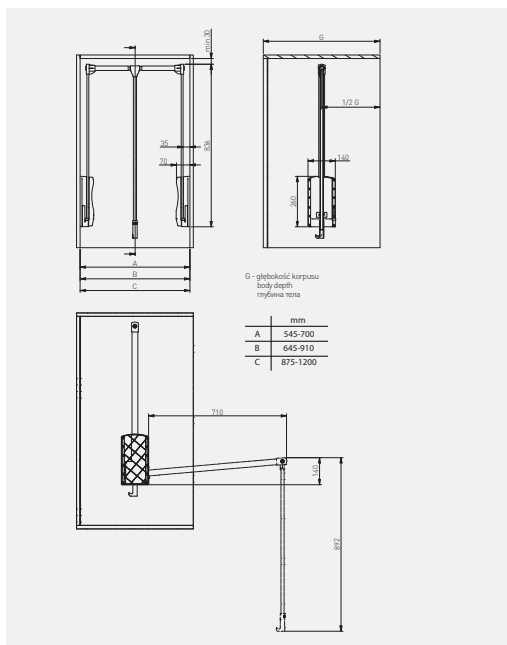

|                |            |   |                                    |                        |
|----------------|------------|---|------------------------------------|------------------------|
| PG-ST83115-10A | 875 - 1200 | 8 | biały<br>white<br>белый            | stal<br>steel<br>сталь |
| PG-ST6083-10A  | 645 - 910  |   |                                    |                        |
| PG-ST4560-10A  | 545 - 700  |   |                                    |                        |
| PG-ST83115-60  | 875 - 1200 |   | antracyt<br>anthracite<br>антрацит |                        |
| PG-ST6083-60   | 645 - 910  |   |                                    |                        |
| PG-ST4560-60   | 545 - 700  |   |                                    |                        |









A  
min./max.



|                |   |     |                         |           |                         |  |
|----------------|---|-----|-------------------------|-----------|-------------------------|--|
| W-W0BU60-BP-10 | komplet bez prowadnic<br>set without slides<br>комплексция без направляющих | 600 |                         | 560 – 568 |                         |  |
| W-W0BU70-BP-10 | komplet bez prowadnic<br>set without slides<br>комплексция без направляющих | 700 |                         | 660 – 668 |                         |  |
| W-W0BU80-BP-10 | komplet bez prowadnic<br>set without slides<br>комплексция без направляющих | 800 | pełny<br>full<br>полное | 760 – 768 | biały<br>white<br>белый | stal,<br>tworzywo<br>steel,<br>plastic<br>сталь,<br>пластмасса |
| W-W0BU90-BP-10 | komplet bez prowadnic<br>set without slides<br>комплексция без направляющих | 900 |                         | 860 – 868 |                         |  |



Wieszak SMART na spodnie  
 SMART wardrobe trouser rack  
 Вешалка SMART для брюк

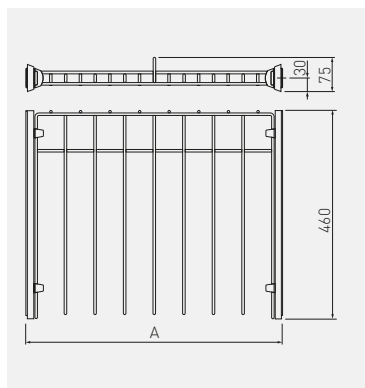

|                |   | mm  | mm | A   | min./max. |  |  |
|----------------|---|-----|----|-----|-----------|--|--|
| W-WSPD60-BP-60 | komplet bez prowadnic<br>set without slides<br>комплектция без направляющих | 600 |    | 560 | 568       |  |  |
| W-WSPD70-BP-60 | komplet bez prowadnic<br>set without slides<br>комплектция без направляющих | 700 |    | 660 | 668       |  |  |
| W-WSPD80-BP-60 | komplet bez prowadnic<br>set without slides<br>комплектция без направляющих | 800 |    | 760 | 768       |  |  |
| W-WSPD90-BP-60 | komplet bez prowadnic<br>set without slides<br>комплектция без направляющих | 900 |    | 860 | 868       |  |  |



A



pełny  
full  
полное

szary  
gray  
серый

stal,  
tworzywo  
steel,  
plastic  
сталь,  
пластмасса







A  
min./max.





|                |   | mm  |                         | A<br>min./max. |                         |  |
|----------------|---|-----|-------------------------|----------------|-------------------------|--|
| W-WSPD60-BP-10 | komplet bez prowadnic<br>set without slides<br>комплектция без направляющих | 600 |                         | 560 – 568      |                         |  |
| W-WSPD70-BP-10 | komplet bez prowadnic<br>set without slides<br>комплектция без направляющих | 700 |                         | 660 – 668      |                         |  |
| W-WSPD80-BP-10 | komplet bez prowadnic<br>set without slides<br>комплектция без направляющих | 800 | pełny<br>full<br>полное | 760 – 768      | biały<br>white<br>белый | stal,<br>tworzywo<br>steel,<br>plastic<br>сталь,<br>пластмасса |
| W-WSPD90-BP-10 | komplet bez prowadnic<br>set without slides<br>комплектция без направляющих | 900 |                         | 860 – 868      |                         |  |

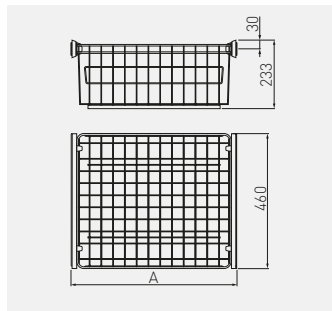

Kosz SMART na bieliznę  
 SMART wardrobe basket  
 Корзина для шкафа SMART



|               |  |  |  A<br>min./max. |  |
|---------------|--|---|--|---|
| W-WK060-BP-60 | komplet bez prowadnic<br>set without slides<br>комплексия без направляющих | 600   | 560 – 568  | stal,<br>tworzywo<br>steel,<br>plastic<br>сталь,<br>пластмасса                    |
| W-WK070-BP-60 | komplet bez prowadnic<br>set without slides<br>комплексия без направляющих | 700   | 660 – 668  |   |
| W-WK080-BP-60 | komplet bez prowadnic<br>set without slides<br>комплексия без направляющих | 800   | 760 – 768  |   |
| W-WK090-BP-60 | komplet bez prowadnic<br>set without slides<br>комплексия без направляющих | 900   | 860 – 868  |   |





A  
min./max.







|               |   |     |                         |           |                         |  |
|---------------|---|-----|-------------------------|-----------|-------------------------|--|
| W-WK060-BP-10 | komplet bez prowadnic<br>set without slides<br>комплексция без направляющих | 600 |                         | 560 – 568 |                         |  |
| W-WK070-BP-10 | komplet bez prowadnic<br>set without slides<br>комплексция без направляющих | 700 |                         | 660 – 668 |                         |  |
| W-WK080-BP-10 | komplet bez prowadnic<br>set without slides<br>комплексция без направляющих | 800 | pełny<br>full<br>полное | 760 – 768 | biały<br>white<br>белый | stal, tworzywo<br>steel, plastic<br>сталь,<br>пластмасса |
| W-WK090-BP-10 | komplet bez prowadnic<br>set without slides<br>комплексция без направляющих | 900 |                         | 860 – 868 |                         |  |

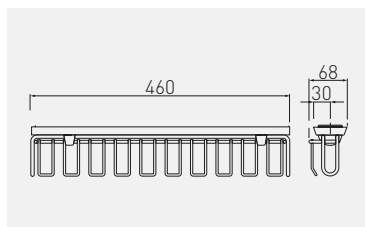

Wieszak SMART na paski i krawaty  
 SMART belt and tie rack  
 Вешалка для ремней и галстуков SMART









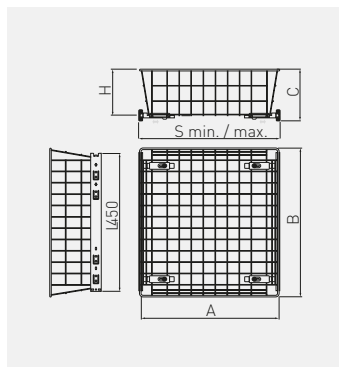

|   |  |   |   |   |
|---|--|---|---|---|
|  |   |  |  |  |
| W-WKRP-BP-60  | komplet bez prowadnic<br>set without slides<br>комплектция без направляющих  | pełny<br>full<br>полное   | szary<br>gray<br>серый  | stal, tworzywo<br>steel, plastic<br>сталь, пластмасса                             |
| W-WKRP-VE-60  | na prowadnicy kulkowej H45 z funkcją cichego zamknięcia<br>on ball bearing slide H45 with soft closing<br>на шариковой направляющей H45 с доводчиком |   |   |   |
| W-WKRP-BP-10  | komplet bez prowadnic<br>set without slides<br>комплектция без направляющих  | biały<br>white<br>белый   |   |   |
| W-WKRP-VE-10  | na prowadnicy kulkowej H45 z funkcją cichego zamknięcia<br>on ball bearing slide H45 with soft closing<br>на шариковой направляющей H45 с доводчиком |   |   |   |



Kosz do szaf  
Wardrobe basket  
Корзина для шкафа







|                 |  |  H<br>mm |  A<br>mm |  B<br>mm |  C<br>mm |  S<br>min/max |  |  |  |   |
|-----------------|---|---|---|---|---|--|---|---|---|---|
| KO-SR100-30-10  |   | 300   | 100   | 255   | 485   | 123  | 260-285   | os cynk<br>galvanized<br>гальваника   | biały<br>white<br>белый   | stal<br>tworzywo<br>steel<br>plastic<br>сталь<br>пластмасса |
| KO-SR100-40-10  |   | 400   | 100   | 355   | 485   | 123  | 360-385   |   |   |   |
| KO-SR100-50-10t |   | 500   | 100   | 455   | 485   | 123  | 460-485   |   |   |   |
| KO-SR100-60-10  |   | 600   | 100   | 555   | 485   | 123  | 560-585   |   |   |   |
| KO-SR150-30-10  |   | 300   | 150   | 255   | 485   | 173  | 260-285   |   |   |   |
| KO-SR150-40-10  |   | 400   | 150   | 355   | 485   | 173  | 360-385   |   |   |   |
| KO-SR150-50-10  |   | 500   | 150   | 455   | 485   | 173  | 460-485   |   |   |   |
| KO-SR150-60-10  |   | 600   | 150   | 555   | 485   | 173  | 560-585   |   |   |   |
| KO-SR200-30-10  |   | 300   | 200   | 255   | 485   | 223  | 260-285   |   |   |   |
| KO-SR200-40-10  |   | 400   | 200   | 355   | 485   | 223  | 360-385   |   |   |   |
| KO-SR200-50-10  |   | 500   | 200   | 455   | 485   | 223  | 460-485   |   |   |   |
| KO-SR200-60-10  |   | 600   | 200   | 555   | 485   | 223  | 560-585   |   |   |   |
| KO-SR100-30-0C  |   | 300   | 150   | 255   | 485   | 123  | 260-285   |   |   |   |
| KO-SR100-40-0C  |   | 400   | 100   | 355   | 485   | 123  | 360-385   |   |   |   |
| KO-SR100-50-0C  |   | 500   | 100   | 555   | 485   | 123  | 560-585   |   |   |   |
| KO-SR100-60-0C  |   | 600   | 100   | 255   | 485   | 173  | 260-285   |   |   |   |
| KO-SR150-30-0C  |   | 300   | 150   | 255   | 485   | 123  | 260-285   |   |   |   |
| KO-SR150-40-0C  |   | 400   | 150   | 355   | 485   | 173  | 360-385   |   |   |   |
| KO-SR150-50-0C  |   | 500   | 150   | 455   | 485   | 173  | 460-485   |   |   |   |
| KO-SR150-60-0C  |   | 600   | 150   | 555   | 485   | 173  | 560-585   |   |   |   |
| KO-SR200-30-0C  |   | 300   | 200   | 255   | 485   | 223  | 260-285   |   |   |   |
| KO-SR200-40-0C  |   | 400   | 200   | 355   | 485   | 223  | 360-385   |   |   |   |
| KO-SR200-50-0C  |   | 500   | 200   | 455   | 485   | 223  | 460-485   |   |   |   |
| KO-SR200-60-0C  |   | 600   | 200   | 555   | 485   | 223  | 560-585   |   |   |   |

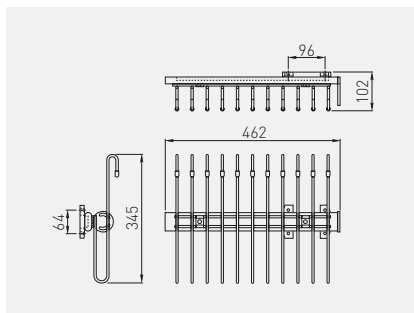

Produkt do montażu na prowadnicach H35, H45 oraz rolkowych - komplet bez prowadnic.  
Product mounted on H35, H45 and roller slides - set without slides  
Продукт для установки на направляющих H35, H45 и роликовых направляющих. Комплект без направляющих.





Wieszak na spodnie podwieszany  
 Wardrobe pull-out trouser rack  
 Вешалка для брюк подвесная

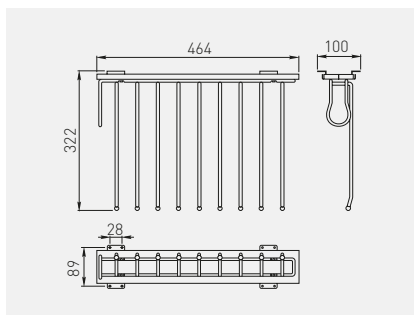

|   |   |   |   |
|---|---|---|---|
|  |  |  |      |
| WW-WSP00-01   | niepełny<br>partial<br>неполное   | chrom, aluminium, czarny<br>chrome, aluminium, black<br>хром, алюминий, чёрный    | stal, aluminium, tworzywo<br>steel, aluminium, plastic<br>сталь, алюминий, пластмасса |





Wieszak WS na spodnie  
 Trouser rack WS  
 Вешалка WS для брюк

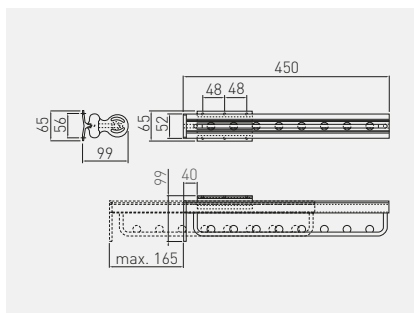

|   |   |   |   |   |
|---|---|---|---|---|
|  |  |  |  |    |
| WW-WSP00-01   | prawy<br>right<br>правый  | niepełny<br>partial<br>неполное   | chrom, aluminium, czarny<br>chrome, aluminium, black<br>хром, алюминий, чёрный      | stal, aluminium, tworzywo<br>steel, aluminium, plastic<br>сталь, алюминий, пластмасса |
| WW-WSL00-01   | lewy<br>left<br>левый   |   |   |   |

Wieszak WU na ubrania  
Clothes hanger WU  
Вешалка WU для одежды







|   |   |   |   |
|---|---|---|---|
|  |  |  |      |
| WW-WUBR00-01  | niepełny<br>partial<br>неполное   | chrom, aluminium, czarny<br>chrome, aluminium, black<br>хром, алюминий, чёрный    | stal, aluminium, tworzywo<br>steel, aluminium, plastic<br>сталь, алюминий, пластмасса |

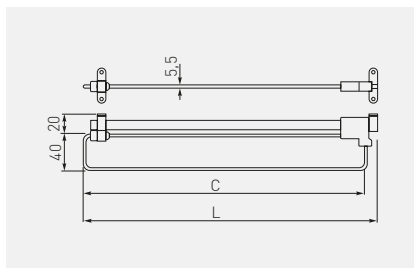







Wieszak WSL  
Hanger WSL  
Вешалка WSL

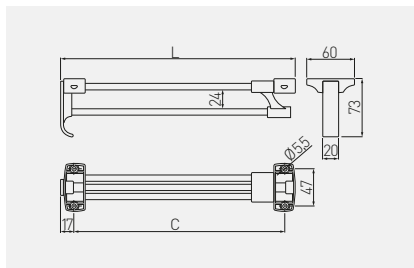

|              |  |  C<br>mm |  L<br>mm |  |  |
|--------------|---|---|---|---|---|
| WW-WSL250-01 |   | 235   | 250   | chrom<br>chrome<br>хром   | stal<br>steel<br>сталь  |
| WW-WSL300-01 |   | 285   | 300   |   |   |
| WW-WSL350-01 |   | 335   | 350   |   |   |
| WW-WSL400-01 |   | 385   | 400   |   |   |
| WW-WSL450-01 |   | 435   | 450   |   |   |
| WW-WSL500-01 |   | 485   | 500   |   |   |





Wieszak WSD wysuwny  
Retractable hanger WSD  
Выдвижная вешалка WSD

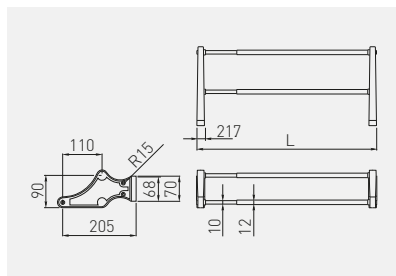

|               |  |  C<br>mm |  L<br>mm |  |  |
|---------------|---|---|---|---|---|
| WW-WSD250-01B |   | 220   | 252   | chrom, czarny<br>chrome, black<br>хром, чёрный                                    | stal, tworzywo<br>steel, plastic<br>сталь, пластмасса                             |
| WW-WSD300-01B |   | 270   | 302   |   |   |
| WW-WSD350-01B |   | 320   | 352   |   |   |
| WW-WSD400-01B |   | 370   | 402   |   |   |
| WW-WSD450-01B |   | 420   | 452   |   |   |
| WW-WSD500-01B |   | 470   | 502   |   |   |

Półka na obuwie  
Shoe rack  
Полка для обуви



|              |  |  L<br>mm |  |    |
|--------------|---|---|---|---|
| PP-P04570-20 |   | 415 - 700   | chrom, aluminium, czarny<br>chrome, aluminium, black<br>хром, алюминий, чёрный      | stal, aluminium, tworzywo<br>steel, aluminium, plastic<br>сталь, алюминий, пластмасса |
| PP-P80110-20 |   | 715 - 1100  | chrom, czarny<br>chrome, black<br>хром, чёрный                                      | stal, tworzywo<br>steel, plastic<br>сталь, пластмасса                                 |





Zawias do półki na obuwie  
Hinge for shoe rack  
Крепление для полки под обувь

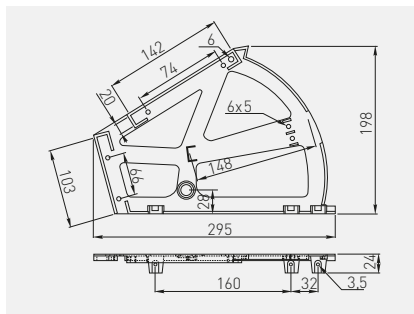

Zastosowanie dla płyty 12 mm  
For 12 mm board  
Крепление к плите 12 мм



|              |                         |                                   |
|--------------|-------------------------|-----------------------------------|
| WW-ZWBUT2-10 | biały / white / белый   | tworzywo<br>plastic<br>пластмасса |
| WW-ZWBUT2-20 | czarny / black / чёрный |                                   |



Pantograf z podnośnikiem gazowym  
Pull-down wardrobe rail – gas  
Пантограф с газовым подъемником

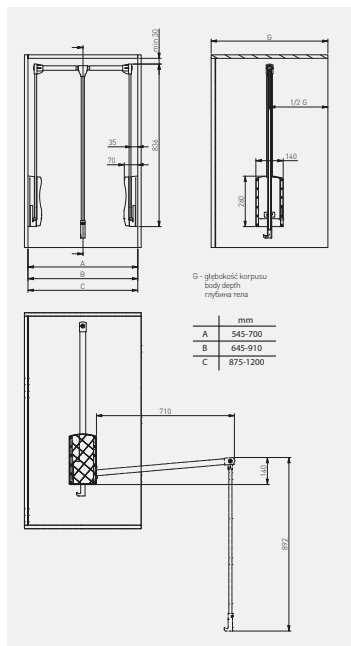





|               |            |    |                           |   |
|---------------|------------|----|---------------------------|---|
| PG-GA4560-10  | 545 – 700  | 12 | biały<br>white<br>белый   | stal, tworzywo<br>steel, plastic<br>сталь, пластмасса |
| PG-GA6083-10  | 645 – 910  |    |                           |   |
| PG-GA83115-10 | 875 – 1200 |    |                           |   |
| PG-GA4560-20  | 545 – 700  | 12 | czarny<br>black<br>чёрный | stal, tworzywo<br>steel, plastic<br>сталь, пластмасса |
| PG-GA6083-20  | 645 – 910  |    |                           |   |
| PG-GA8311520  | 875 – 1200 |    |                           |   |

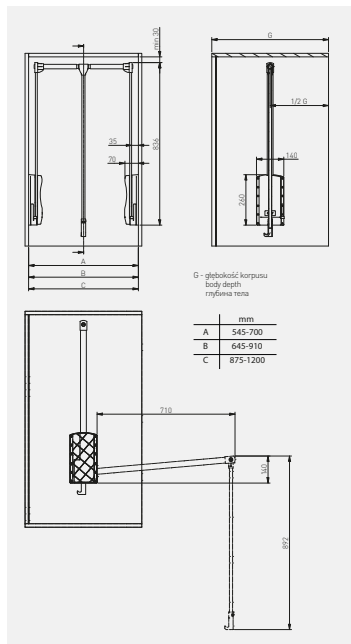

Pantograf z podnośnikiem olejowym  
 Pull-down wardrobe rail – oil  
 Пантограф с масляным подъемником



|               |  |  |  |  |  |                         |
|---------------|---|---|---|---|---|-------------------------|
| PG-AL4560-20  | 545 – 700   | 8   | aluminium / aluminium / алюминий  |   | aluminium, tworzywo<br>aluminium, plastic<br>алюминий, пластмасса                 |                         |
| PG-AL6083-20  | 645 – 910   |   |   |   |   |                         |
| PG-AL8311520  | 875 – 1200  |   |   |   |   |                         |
| PG-ST4560-10  | 545 – 700   |   |   |   | stal, tworzywo<br>steel, plastic<br>сталь, пластмасса                             |                         |
| PG-ST4560-20  | 645 – 910   |   |   |   |   | biały / white / белый   |
| PG-ST6083-10  |   |   |   |   |   | czarny / black / чёрный |
| PG-ST6083-20  |   |   |   |   |   | biały / white / белый   |
| PG-ST83115-10 | 875 – 1200  |   |   |   |   | czarny / black / чёрный |
| PG-ST8311520  |   | biały / white / белый   |   |   |   |                         |
|               |   |   | czarny / black / чёрный   |   |   |                         |





Segregator PRACTI ECO 400  
 Trash bin PRACTI ECO 400  
 Сегрегатор PRACTI ECO 400

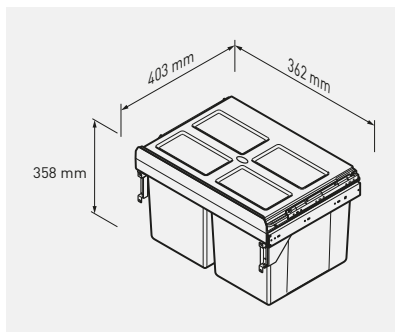

PB-45-400MF-2X16-60A

400

2 x 16 L

antracyt  
 anthracite  
 антрацит

tworzywo / plastic / пластмасса



Segregator PRACTI ECO 300  
 Trash bin PRACTI ECO 300  
 Сепаратор PRACTI ECO 300





PB-45-0010X3-60A

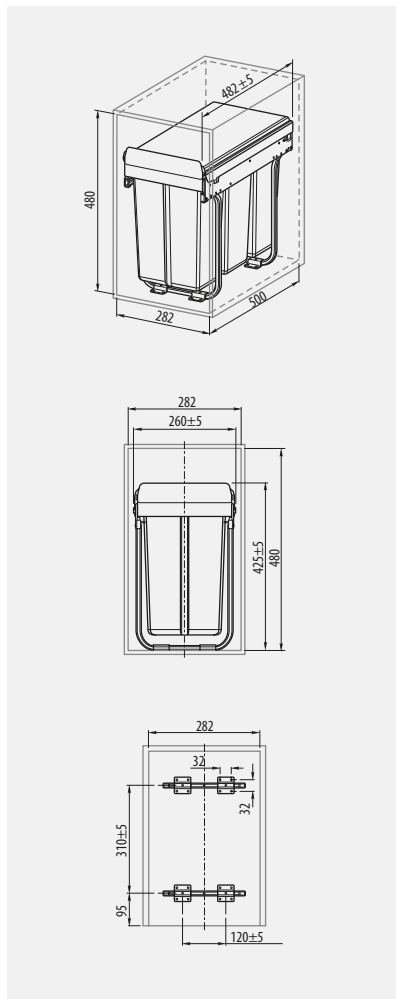

PB-45-002010-60A



Na prowadnicy kulkowej H45 z cichym domykiem  
 On ball bearing slide H45 with soft closing  
 На шариковой направляющей H45 с доводчиком

|                  |  | <br>mm |  |  |  |
|------------------|---|---|---|---|---|
| PB-45-0010X3-60A |   | 300   | 3 x 10 L  | antracyt<br>anthracite<br>антрацит  | tworzywo / plastic / пластмасса   |
| PB-45-002010-60A |   | 300   | 10 L, 20 L  |   |   |



Segregator PRACTI ECO 400  
 Trash bin PRACTI ECO 400  
 Сегрегатор PRACTI ECO 400









PB-45-002X20-60A

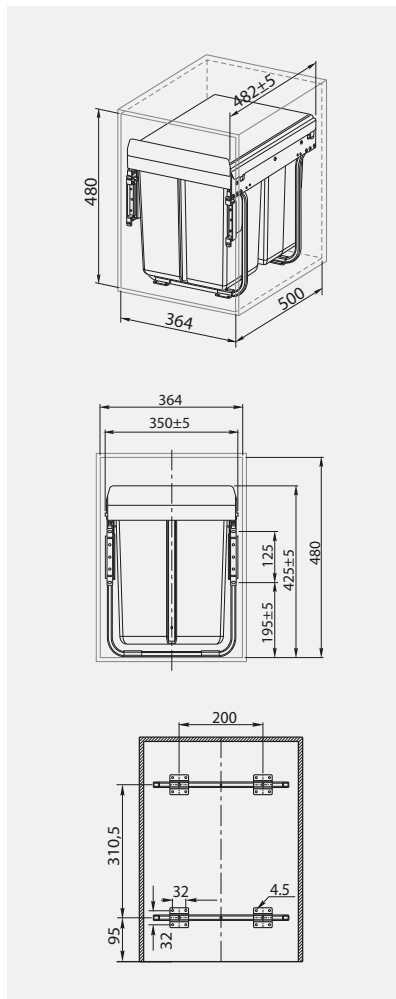

PB-45-202X10-60A

Na prowadnicy kulkowej H45 z cichym domykiem  
 On ball bearing slide H45 with soft closing  
 На шариковой направляющей H45 с доводчиком



|                  |  |  |  |  |  |
|------------------|---|---|---|---|---|
| PB-45-002X20-60A | 400   | 2 x 20 L  | antracyt<br>anthracite<br>антрацит  | tworzywo / plastic / пластмасса   |   |
| PB-45-202X10-60A | 400   | 20 L, 2 x 10 L  |   |   |   |



Segregator PRACTI ECO 400 z mocowaniem przednim  
 Trash bin PRACTI ECO 400 with door mount bracket  
 Сегрегатор PRACTI ECO 400 с передним креплением



PB-45-MF002X20-60A



PB-45-MF202X10-60A

Na prowadnicy kulkowej H45 z cichym domykiem  
 On ball bearing slide H45 with soft closing  
 На шариковой направляющей H45 с доводчиком

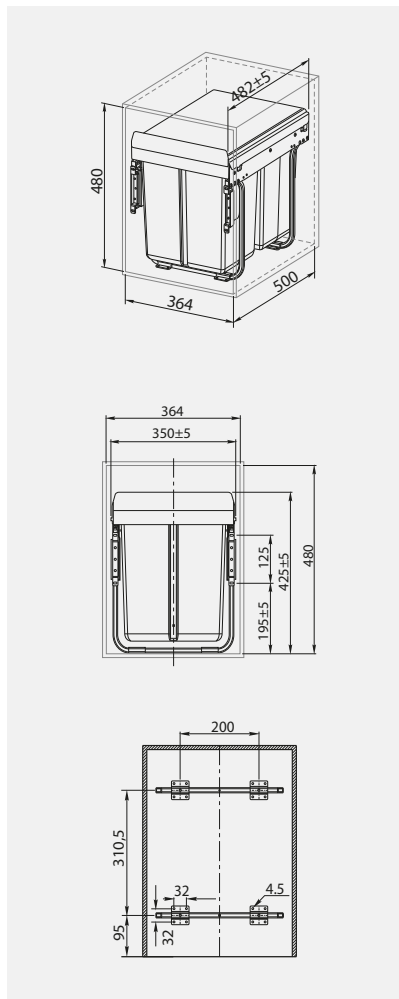

|                    |     |                |                                    |                                 |
|--------------------|-----|----------------|------------------------------------|---------------------------------|
| PB-45-MF002X20-60A | 400 | 2 x 20 L       | antracyt<br>anthracite<br>антрацит | tworzywo / plastic / пластмасса |
| PB-45-MF202X10-60A |     | 20 L, 2 x 10 L |                                    |                                 |



Segregator PRACTI ECO 450, niski  
 Trash bin PRACTI ECO 450, low  
 Сегрегатор PRACTI ECO 450, низкий



PB-45-002X15-60A

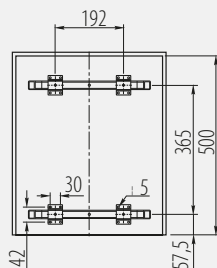
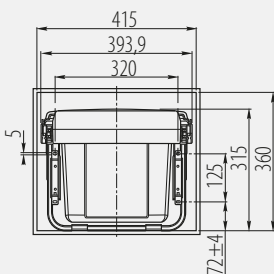
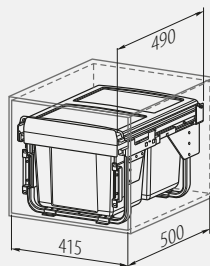

Na prowadnicy z cichym domykiem  
 On slide with soft closing  
 На направляющей с доводчиком



|                  |     |          |                                    |                                 |
|------------------|-----|----------|------------------------------------|---------------------------------|
| PB-45-002X15-60A | 450 | 2 x 15 L | antracyt<br>anthracite<br>антрацит | tworzywo / plastic / пластмасса |
|------------------|-----|----------|------------------------------------|---------------------------------|





Segregator PRACTI ECO 450 niski z mocowaniem przednim  
 Trash bin PRACTI ECO 450 low with door mount bracket  
 Сегрегатор PRACTI ECO 450 низкий с передним креплением



PB-45-MF2X15-60A

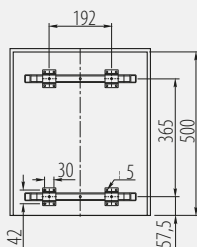
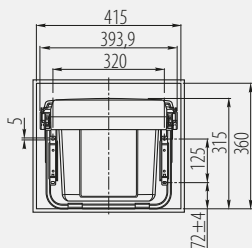
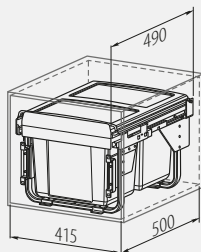

Na prowadnicy z cichym domykiem  
 On slide with soft closing  
 На направляющей с доводчиком



|                  |     |          |                                    |                                 |
|------------------|-----|----------|------------------------------------|---------------------------------|
| PB-45-MF2X15-60A | 450 | 2 x 15 L | antracyt<br>anthracite<br>антрацит | tworzywo / plastic / пластмасса |
|------------------|-----|----------|------------------------------------|---------------------------------|



Segregator PRACTI ECO 450 wysoki  
 Trash bin PRACTI ECO 450 high  
 Сегрегатор PRACTI ECO 450 высокий



PB-45-450-2X20-60A



PB-45-0202X10-60A

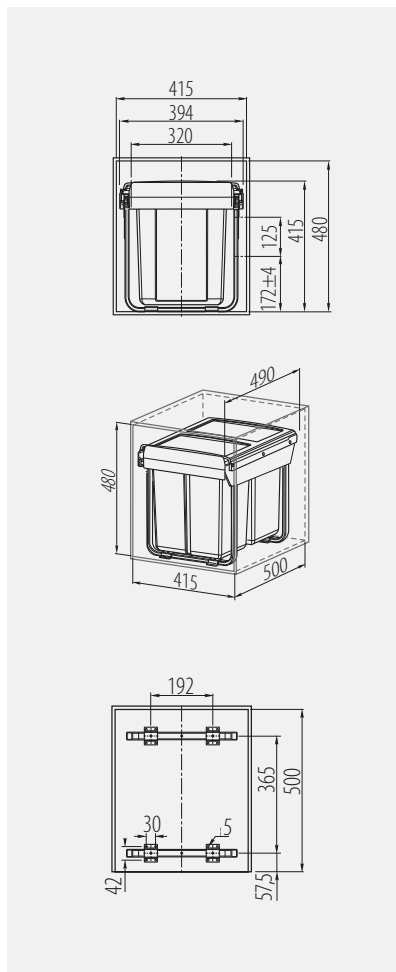

Na prowadnicy z cichym domykiem  
 On slide with soft closing  
 На направляющей с доводчиком



|                    |     |                |                                    |                                 |
|--------------------|-----|----------------|------------------------------------|---------------------------------|
| PB-45-450-2X20-60A | 450 | 2 x 20 L       | antracyt<br>anthracite<br>антрацит | tworzywo / plastic / пластмасса |
| PB-45-0202X10-60A  |     | 20 L, 2 x 10 L |                                    |                                 |



Segregator PRACTI ECO 450 wysoki z mocowaniem przednim  
 Trash bin PRACTI ECO 450 high with door mount bracket  
 Сегрегатор PRACTI ECO 450 высокий с передним креплением



PB-45-450MF202X10-60A



PB-45-MF2X20-60A

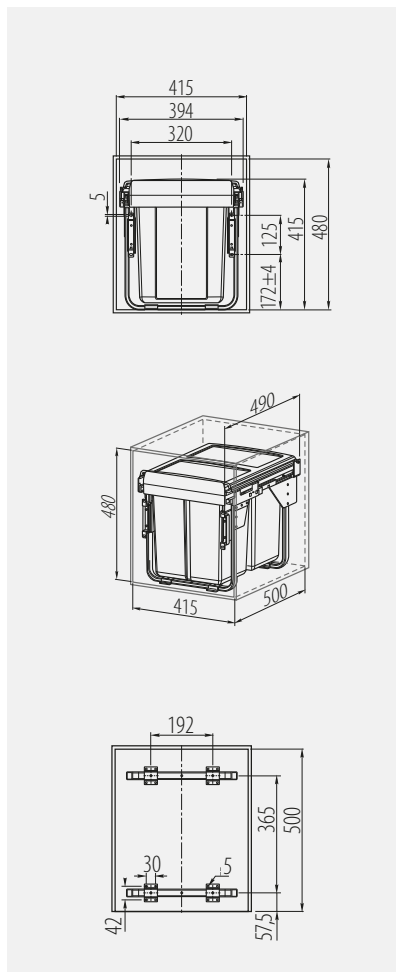

Na prowadnicy z cichym domykiem  
 On slide with soft closing  
 На направляющей с доводчиком



|                       |     |                |                                    |                                 |
|-----------------------|-----|----------------|------------------------------------|---------------------------------|
| PB-45-450MF202X10-60A | 450 | 20 L, 2 x 10 L | antracyt<br>anthracite<br>антрацит | tworzywo / plastic / пластмасса |
| PB-45-MF2X20-60A      |     | 2 x 20 L       |                                    |                                 |



Segregator PRACTI ECO 600 wysoki z mocowaniem przednim  
 Trash bin PRACTI ECO 600 high with door mount bracket  
 Сегрегатор PRACTI ECO 600 высокий с передним креплением



PB-45-MF342X17-60A



PB-45-MF2X34-60A

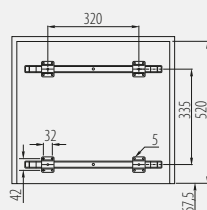
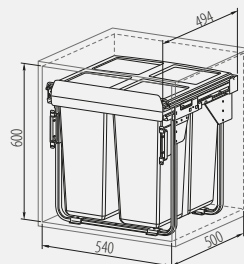
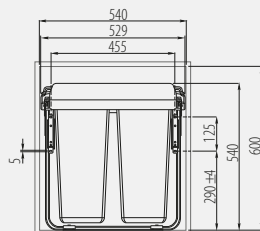

Na prowadnicy z cichym domykiem  
 On slide with soft closing  
 На направляющей с доводчиком



|                    |     |                |                                    |                                 |
|--------------------|-----|----------------|------------------------------------|---------------------------------|
| PB-45-MF342X17-60A | 600 | 34 L, 2 x 17 L | antracyt<br>anthracite<br>антрацит | tworzywo / plastic / пластмасса |
| PB-45-MF2X34-60A   |     | 2 x 34 L       |                                    |                                 |



Segregator PRACTI ECO 600  
 Trash bin PRACTI ECO 600  
 Сегрегатор PRACTI ECO 600

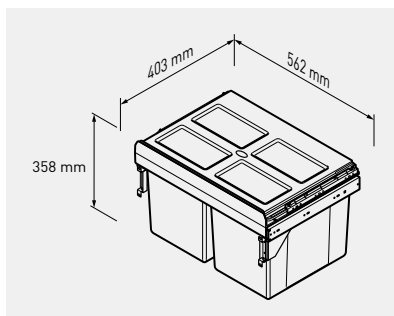

|                      |     |          |                                    |                                 |
|----------------------|-----|----------|------------------------------------|---------------------------------|
| PB-45-600MF-2X27-60A | 600 | 2 x 27 L | antracyt<br>anthracite<br>антрацит | tworzywo / plastic / пластмасса |
|----------------------|-----|----------|------------------------------------|---------------------------------|



Segregator AXISPACE  
Trash bin AXISPACE  
Серператор AXISPACE

NEW



|                      |     |                   |                                    |   |
|----------------------|-----|-------------------|------------------------------------|---|
| PB-AS-600-1X15L-2X7L | 600 | 1 x 15 L, 2 x 7 L | antracyt<br>anthracite<br>антрацит | tworzywo sztuczne z cząsteczkami grafenu*<br>plastic with graphene particles*<br>пластик с частицами графена* |
| PB-AS-600-1X15L-3X7L |     | 1 x 15 L, 3 x 7 L |                                    |   |
| PB-AS-600-2X15L      |     | 2 x 15 L          |                                    |   |
| PB-AS-600-2X15L-2X7L | 700 | 2 x 15 L, 2 x 7 L |                                    |   |
| PB-AS-700-2X15L-2X7L |     | 2 x 15 L, 2 x 7 L |                                    |   |
| PB-AS-800-2X15L-2X7L | 800 | 2 x 15 L, 2 x 7 L |                                    |   |
| PB-AS-800-4X15L      |     | 4 x 15 L          |                                    |   |
| PB-AS-900-4X15L      |     | 4 x 15 L          |                                    |   |



\*grafen to nanomateriał utworzony z węgla o działaniu antybakteryjnym i antygrzybicznym. Jest on w stanie wyeliminować ze swojej powierzchni nawet do 99% drobnoustrojów w przeciągu 120 minut  
graphene is a nanomaterial made of carbon with antibacterial and antifungal properties. It is able to eliminate up to 99% of microorganisms from its surface within 120 minutes  
Графен — это наноматериал из углерода с антибактериальными и противогрибковыми свойствами. Он способен устранить до 99% микроорганизмов со своей поверхности в течение 120 минут

## Segregator MULTINO Trash bin MULTINO Серпегатор MULTINO

Przeznaczony do szuflad Modern Box / Axis Pro  
For Modern Box / Axis Pro drawers  
Только для ящиков Modern Box / Axis Pro



PB-93004162601

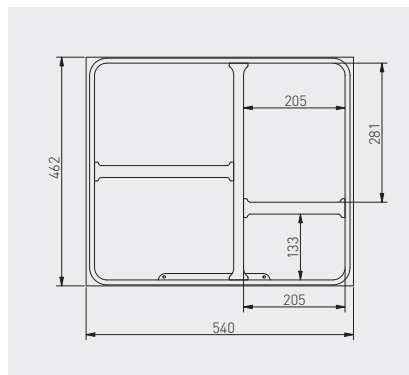

|                |     |                   |                                      |                                     |
|----------------|-----|-------------------|--------------------------------------|-------------------------------------|
|                |     |                   |                                      |                                     |
| PB-93004162601 | 540 | 3 x 15 L, 1 x 7 L | anthrazit<br>anthracite<br>antracita | Kunststoff<br>plastique<br>plástico |



## Kosz CIRCA Trash bin CIRCA Корзина CIRCA

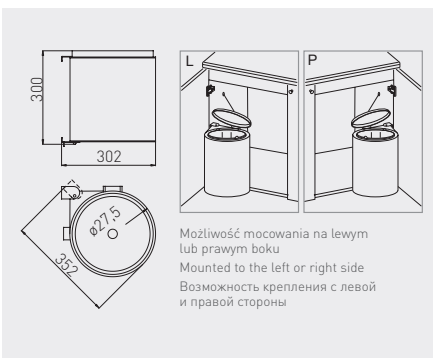





|              |      |                      |                                 |
|--------------|------|----------------------|---------------------------------|
|              |      |                      |                                 |
| PB-91024160V | 11 L | szary / gray / серый | tworzywo / plastic / пластмасса |

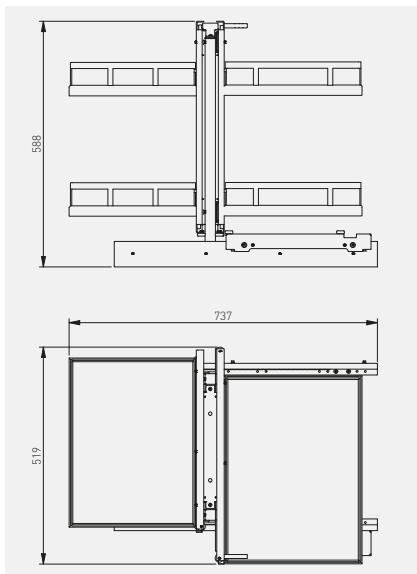

Corner MovixPro 450/500  
 Corner MovixPro 450/500  
 Корзина MovixPro 450/500

NEW



|  |  mm |  |  |
|---|--|---|---|
| KO-WMC450-60  | 450  | antracyt<br>anthracite<br>антрацит  | stal<br>steel<br>сталь  |
| KO-WMC450-01B   |  | chrom + biala mata<br>chrome + white mat<br>хром + белый коврик                   |   |
| KO-WMC450-01  |  | chrom + mata antracyt<br>chrome + anthracite mat<br>хром + антрацитовый мат       |   |
| KO-WMC500-60  | 500  | antracyt<br>anthracite<br>антрацит  |   |
| KO-WMC500-01B   |  | chrom + biala mata<br>chrome + white mat<br>хром + белый коврик                   |   |
| KO-WMC500-01  |  | chrom + mata antracyt<br>chrome + anthracite mat<br>хром + антрацитовый мат       |   |





Corner MovixPro 450  
 Corner MovixPro 450  
 Корзина MovixPro 450

NEW

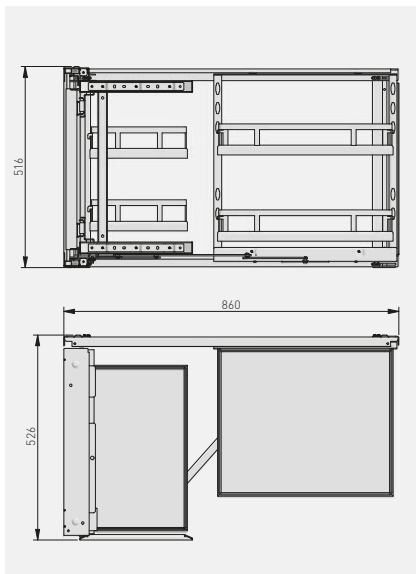

|               |   |                        |
|---------------|---|------------------------|
| KO-UMC450-60  | antracyt<br>anthracite<br>антрацит                              | stal<br>steel<br>сталь |
| KO-UMC450-01B | chrom + biata mata<br>chrome + white mat<br>хром + белый коврик |                        |
| KO-UMC450-01  | chrome<br>chrome<br>хром  |                        |



Cargo boczne MOVIX PRO  
Side cargo MOVIX PRO  
Боковое карго MOVIX PRO

NEW

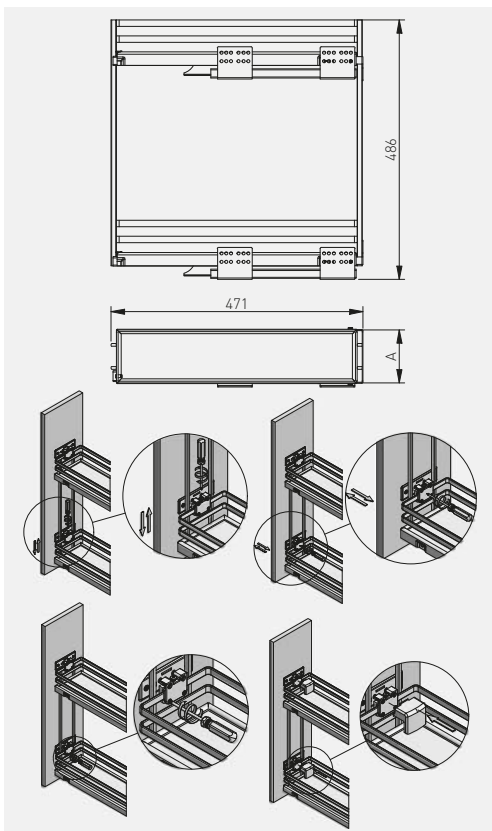

|              |     |                                     |   |                        |
|--------------|-----|-------------------------------------|---|------------------------|
| KO-150BO-60  | 150 | осынок<br>galvanized<br>гальванника | antracyt<br>anthracite<br>антрацит  | stal<br>steel<br>сталь |
| KO-200BO-60  | 200 |                                     |   |                        |
| KO-150BO-01  | 150 |                                     |   |                        |
| KO-200BO-01  | 200 |                                     |   |                        |
| KO-150BO-01B | 150 |                                     |   |                        |
| KO-200BO-01B | 200 |                                     |   |                        |
|              |     |                                     | chrom + mata antracyt<br>chrome + anthracite mat<br>хром + антрацитовый мат |                        |
|              |     |                                     | chrom + biala mata<br>chrome + white mat<br>хром + белый коврик             |                        |



\* Produkt nie zawiera prowadnic.  
Produkty komplementarne: dla rozmiarów szafek 150, 200 mm – prowadnice z cichym domykiem PB-KO450BO-L1 lub PB-KO450BO-R1.  
\* Product does not include slides.  
Complementary products: for cabinet sizes 150, 200 mm - PB-KO450BO-L1 and PB-KO450BO-R1 slides with soft close.  
\* В состав продукта не входят направляющие  
Дополнительные продукты: для шкафов размером 150, 200 мм - направляющие с доводчиком PB-KO450BO-L1 и PB-KO450BO-R1.



Cargo boczne MOVIX PRO  
Side cargo MOVIX PRO  
Боковое карго MOVIX PRO

NEW

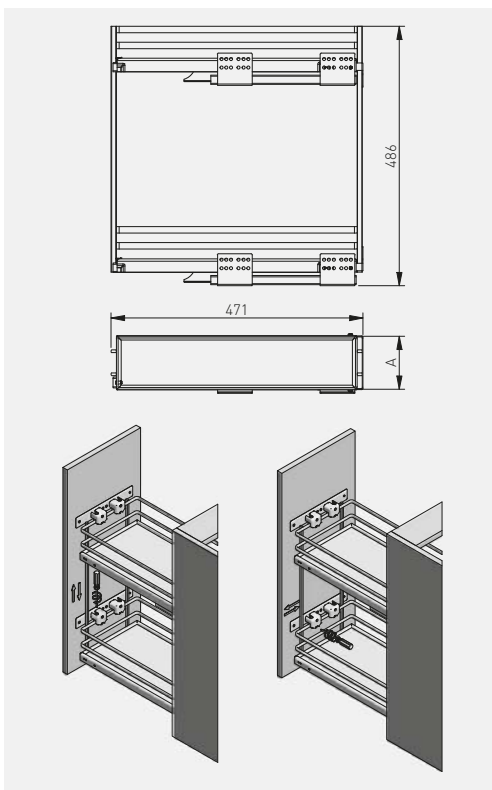

|              |     |                                   |   |                        |
|--------------|-----|-----------------------------------|---|------------------------|
| KO-300BO-60  | 300 | осынк<br>galvanized<br>гальваника | antracyt<br>anthracite<br>антрацит  | stal<br>steel<br>сталь |
| KO-400BO-60  | 400 |                                   | chrom + mata antracyt<br>chrome + anthracite mat<br>хром + антрацитовый мат |                        |
| KO-500BO-60  | 500 |                                   |   |                        |
| KO-300BO-01  | 300 |                                   |   |                        |
| KO-400BO-01  | 400 |                                   | chrom + biala mata<br>chrome + white mat<br>хром + белый коврик             |                        |
| KO-500BO-01  | 500 |                                   |   |                        |
| KO-300BO-01B | 300 |                                   |   |                        |
| KO-400BO-01B | 400 |                                   |   |                        |
| KO-500BO-01B | 500 |                                   |   |                        |



- \* Produkt nie zawiera prowadnic.
- \* Produkty komplementarne: dla rozmiarów szafek 300, 400, 500 mm – prowadnice z cichym domykaniem PB-KO450BO.
- \* Product does not include slides.
- \* Complementary products: for cabinet sizes 300, 400, 500 mm - PB-KO450BO slides with soft close.
- \* В состав продукта не входят направляющие
- \* Дополнительные продукты: для шкафов размером 300, 400, 500 мм - направляющие с доводчиком PB-KO450BO.

Cargo boczne na prowadnicach dolnego montażu

Side cargo on bottom mount slides

Боковая корзина карго на направляющих нижнего монтажа

NEW

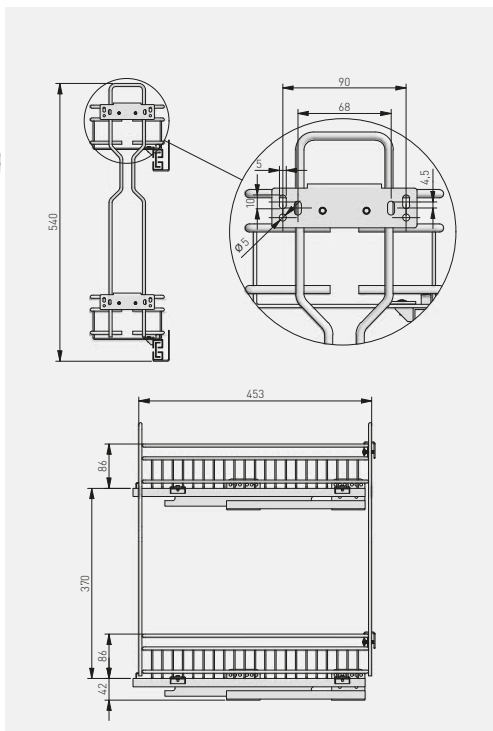

|               | mm  |                         |                        |
|---------------|-----|-------------------------|------------------------|
| KO-150BO-E-01 | 150 | chrom<br>chrome<br>хром | stal<br>steel<br>сталь |
| KO-200BO-E-01 | 200 |                         |                        |



\* Produkt nie zawiera prowadnic.

Produkty komplementarne: prowadnice z cichym domykiem PB-KO450BO-E-L, PB-KO450BO-E-R.

\* Product does not include slides.

Complementary products - slides with soft close PB-KO450BO-E-L, PB-KO450BO-E-R.

\* Продукт не включает направляющие.

Дополнительные продукты - направляющие с доводчиком PB-KO450BO-E-L, PB-KO450BO-E-R.

Ociekarka dwupoziomowa do montażu  
Two tier dish drying rack  
Двухуровневая сушилка для посуды



|             |   |   |
|-------------|---|---|
| OC-A0150-06 |   |   |
| OC-A0160-06 | stal szcztokowana<br>brushed steel<br>шлифованная сталь | stal nierdzewna<br>stainless steel<br>нержавеющая сталь |
| OC-A0170-06 |   |   |
| OC-A0180-06 |   |   |
| OC-A0190-06 |   |   |

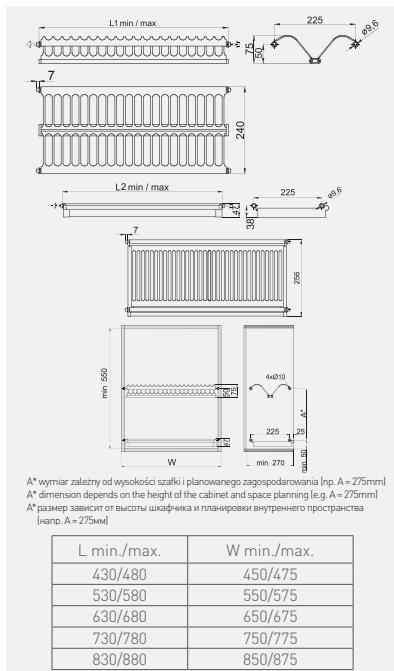

Ociekarka jednopoziomowa do montażu  
Dish drying rack  
Сушилка для посуды



|             |   |   |
|-------------|---|---|
| OC-A0660-06 | stal szcztokowana<br>brushed steel<br>шлифованная сталь | stal nierdzewna<br>stainless steel<br>нержавеющая сталь |
| OC-A0680-06 |   |   |

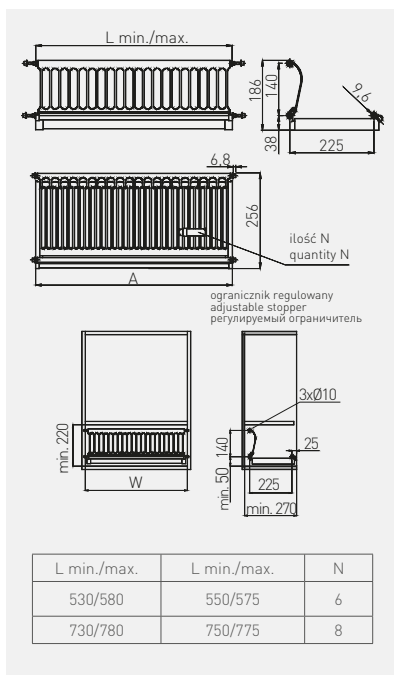

Ociekarka dwupoziomowa do montażu  
Two tier dish drying rack  
Двухуровневая сушилка для посуды

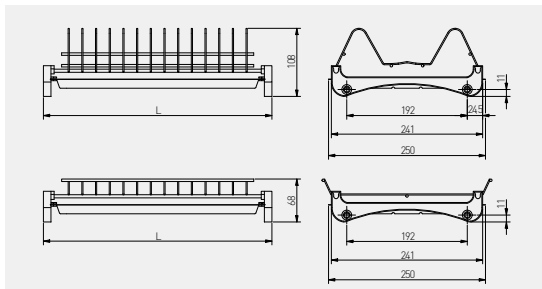

|                   |  |     |     |                         |  |
|-------------------|--|-----|-----|-------------------------|--|
| OC-2PV340-02-18   | do płyty 18 mm<br>for 18 mm board<br>для поверхности 18 мм | 364 | 400 | chrom<br>chrome<br>хром | stal nierdzewna, tworzywo<br>stainless steel, plastic<br>нержавеющая сталь, пластмасса |
| OC-2PV345-02-18   |  | 414 | 450 |                         |  |
| OC-2PV350-02-18   |  | 464 | 500 |                         |  |
| OC-2PV360-02-18   |  | 564 | 600 |                         |  |
| OC-2PV360-02-18A* |  | 564 | 600 |                         |  |
| OC-2PV370-02-18   |  | 664 | 700 |                         |  |
| OC-2PV380-02-18   |  | 764 | 800 |                         |  |
| OC-2PV380-02-18A* |  | 764 | 800 |                         |  |
| OC-2PV390-02-18   |  | 864 | 900 |                         |  |



Ociekarka dwupoziomowa A04, wolnostojąca  
 Two tier dish drying rack A04  
 Сушилка для посуды настольная A04, двухуровневая

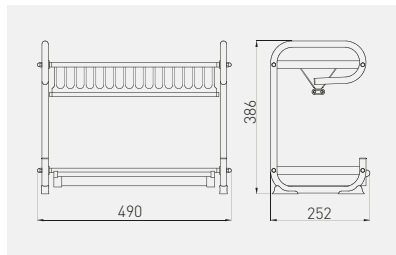

OC-A0450-06



stal szorstkowana  
 brushed steel  
 шлифованная сталь



stal nierdzewna  
 stainless steel  
 нержавеющая сталь



Ociekarka dwupoziomowa A03, wolnostojąca  
 Two tier dish drying rack A03  
 Сушилка для посуды настольная A03, двухуровневая

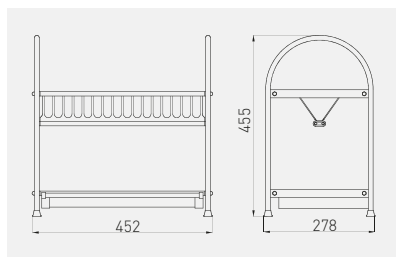

OC-A0350K-06



stal szorstkowana  
 brushed steel  
 шлифованная сталь



stal nierdzewna  
 stainless steel  
 нержавеющая сталь





Ociekarka dwupoziomowa z organizerem, wolnostojąca  
 Two tier dish drying rack with organizer  
 Сушилка для посуды и столовых приборов настольная, двухуровневая

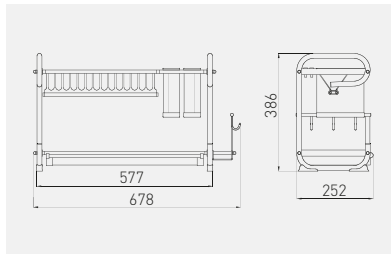

OC-A0460D-06



stal szczotkowana  
 brushed steel  
 шлифованная сталь



stal nierdzewna  
 stainless steel  
 нержавеющая сталь



Ociekarka zwijana  
 Roll-up drying rack  
 Складная сушилка

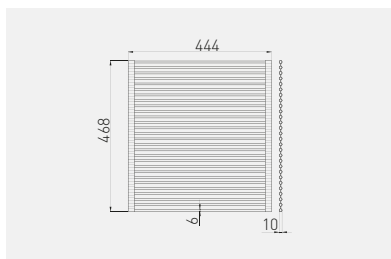
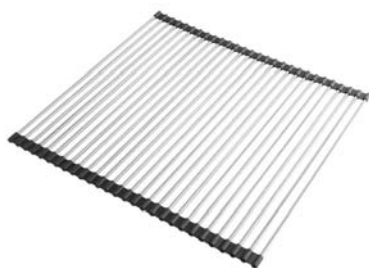

OC-E0707D-CZ



stal szczotkowana, czarny  
 brushed steel, black  
 шлифованная сталь, чёрный



stal nierdzewna  
 stainless steel  
 нержавеющая сталь



Półka pod klawiaturę z prowadnicą kulkową 27 mm  
 Keyboard shelf with 27 mm drawer slide  
 Полка для клавиатуры с шариковой направляющей 27 мм

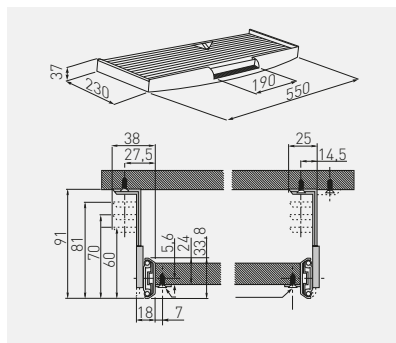

PU-KEY027-20



czarny / black / чёрны



tworzywo  
 plastic  
 пластмасса

PU-KEY027-60

szary / gray / серый



Półka pod klawiaturę z podkładką na myszkę  
 Keyboard shelf with mouse pad  
 Полка для клавиатуры с подставкой для мыши

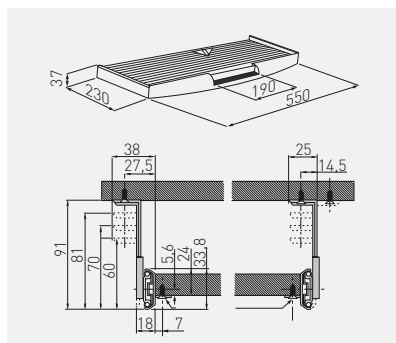

PU-KEYM27-20



czarny / black / чёрны



tworzywo  
 plastic  
 пластмасса

PU-KEYM27-60

szary / gray / серый



Wózek pod komputer  
Computer trolley  
Передвижная подставка под компьютер

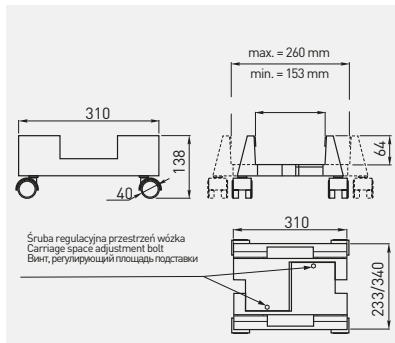

|              |                         |                                |
|--------------|-------------------------|--------------------------------|
| PU-PKO-00-20 | czarny / black / чёрный | tworzywo plastic<br>пластмасса |
| PU-PKO-00-60 | szary / gray / серый    |                                |



Hub – 4 porty USB  
Hub – 4 USB ports  
Удлинитель на 4 входа USB

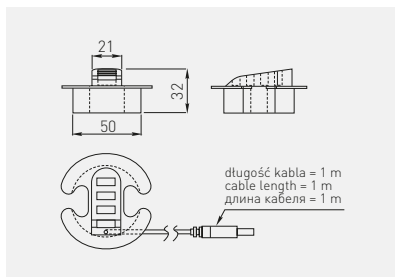

|              |                               |                                |
|--------------|-------------------------------|--------------------------------|
| HB-USB-4X-60 | srebrny / silver / серебряный | tworzywo plastic<br>пластмасса |
|--------------|-------------------------------|--------------------------------|



Przepust MERIDA 80  
 Desk cable outlet MERIDA 80  
 Пропуск для кабеля MERIDA 80

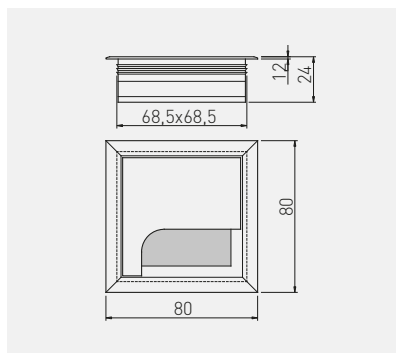





|   |   |   |   |
|---|---|---|---|
|  | <br>mm |  |  |
| LB-K80X80-05  | 80 x 80   | aluminium / aluminium / алюминий  |   |
| LB-K80X80-20  |   | czarny / black / чёрный   |   |
|   |   | aluminium<br>aluminium<br>алюминий  |   |

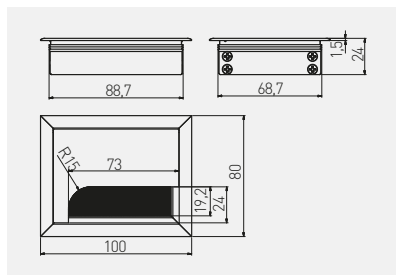

Przepust MERIDA 100  
 Desk cable outlet MERIDA 100  
 Пропуск для кабеля MERIDA 100





|   |   |   |   |
|---|---|---|---|
|  | <br>mm |  |  |
| LB-80X100-05  | 80 x 100  | aluminium / aluminium / алюминий  |   |
| LB-80X100-20  |   | czarny / black / чёрный   |   |
|   |   | aluminium<br>aluminium<br>алюминий  |   |

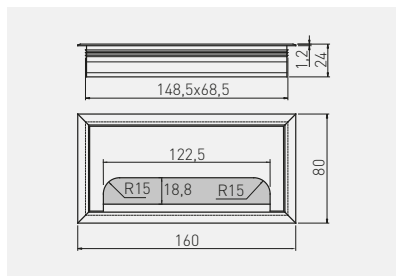

Przepust MERIDA 160  
 Desk cable outlet MERIDA 160  
 Пропуск для кабеля MERIDA 160



|   |   |   |   |
|---|---|---|---|
|  | <br>mm |  |  |
| LB-80X160-05  | 80 x 160  | aluminium / aluminium / алюминий  | aluminium   |
| LB-80X160-20  |   | czarny / black / чёрный   | aluminium<br>aluminium<br>алюминий  |



Przepust MERIDA 280  
 Desk cable outlet MERIDA 280  
 Пропуск для кабеля MERIDA 280

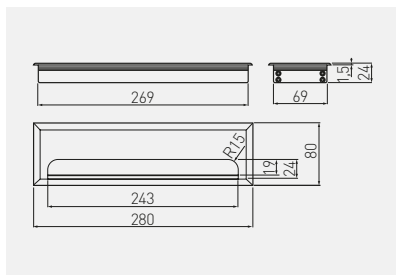





|   |   |   |   |
|---|---|---|---|
|  | <br>mm |  |  |
| LB-80X280-05  | 80 x 280  | aluminium / aluminium / алюминий  | aluminium   |
| LB-80X280-20  |   | czarny / black / чёрный   | aluminium<br>aluminium<br>алюминий  |

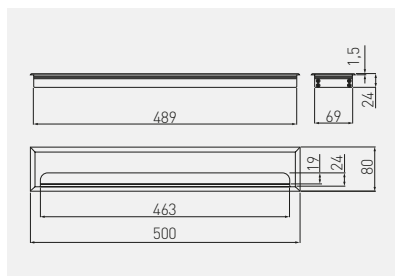

Przepust MERIDA 500  
Desk cable outlet MERIDA 500  
Пропуск для кабеля MERIDA 500



|   |   |   |   |
|---|---|---|---|
|  |  |  |  |
| LB-80X500-05  | 80 x 500  | aluminium / aluminium / алюминий  | aluminium   |
| LB-80X500-20  |   | czarny / black / чёрный   | aluminium<br>aluminium<br>алюминий  |



Przepust LBF  
Desk cable grommet LBF  
Пропуск для кабеля LBF

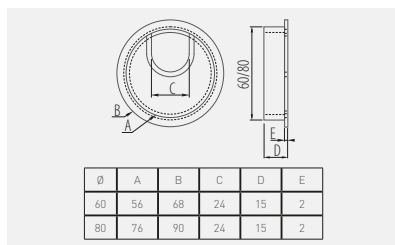

|   |   |   |   |
|---|---|---|---|
|  |  |  |  |
| PM-LBFI60-01  | 60  | chrom / chrome / хром   | ZnAl  |
| PM-LBFI60-02  |   | satyna / satin / сатин  |   |
| PM-LBFI60-05  |   | aluminium / aluminium / алюминий  |   |
| PM-LBFI60-06  |   | stal szcztokowana / brushed steel / шлифованная сталь                               |   |
| PM-LBFI60-20M   | czarny mat / black matt / чёрный матовый  |   |   |
| PM-LBFI80-01  | 80  | chrom / chrome / хром   |   |
| PM-LBFI80-02  |   | satyna / satin / сатин  |   |
| PM-LBFI80-05  |   | aluminium / aluminium / алюминий  |   |
| PM-LBFI80-06  |   | stal szcztokowana / brushed steel / шлифованная сталь                               |   |
| PM-LBFI80-20M   | czarny mat / black matt / чёрный матовый  |   |   |



Przepust PLF  
Desk cable grommet PLF  
Пропуск для кабеля PLF

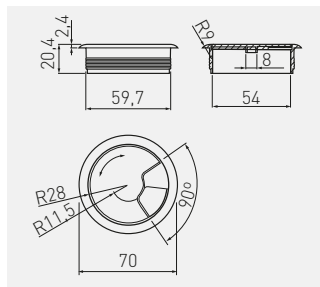

| PM-PLFI60-05 | aluminium / aluminium / алюминий             |                                   |
|--------------|--|-----------------------------------|
| PM-PLFI60-10 | biały / white / белый                        |                                   |
| PM-PLFI60-20 | czarny / black / чёрный                      |                                   |
| PM-PLFI60-30 | szary / gray / серый                         |                                   |
| PM-PLFI60-43 | jasny brąz / light brown / светло-коричневый |                                   |
| PM-PLFI60-45 | orzech / walnut / цвет орех                  | tworzywo<br>plastic<br>пластмасса |
| PM-PLFI60-47 | buk / beech / бук                            |                                   |
| PM-PLFI60-49 | klon / maple / клен                          |                                   |
| PM-PLFI60-50 | beż / beige / бежевый                        |                                   |
| PM-PLFI60-51 | kalwados / calvados / кальвадос              |                                   |



Zamek K-138  
 Lock K-138  
 Замок K-138

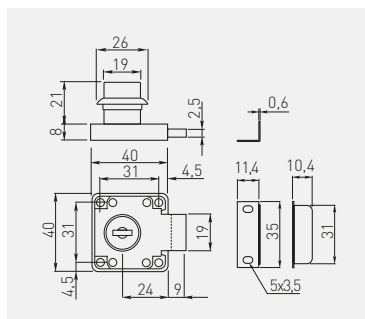

ZZ-KM-138-01-S



chrom / chrome / хром



ZnAl, stal / ZnAl, steel / ZnAl, сталь

Zamek Z-138 z kluczem łamanym  
 Lock Z-138 with folding key  
 Замок Z-138 со складным ключом

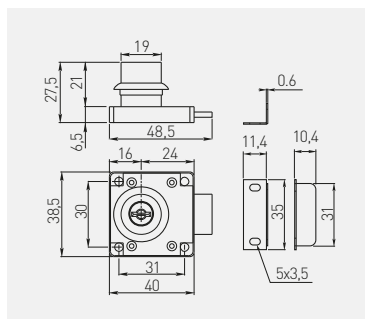

ZZ-ZN-138-01



chrom / chrome / хром



ZnAl, stal / ZnAl, steel / ZnAl, сталь



Zamek C-138 z kluczem cyfrowym  
 Lock C-138 with key  
 Замок C-138 с цифровым ключом

Kompatybilny z kluczem MASTER  
 Compatible with MASTER key  
 Подходит для ключа MASTER

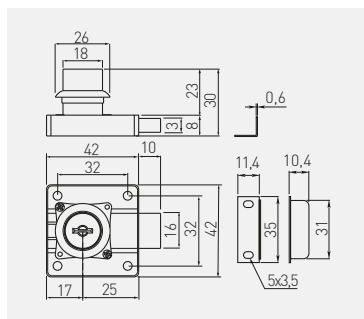

ZZ-CF-138-01



chrom / chrome / хром



ZnAl, stal / ZnAl, steel / ZnAl, сталь

Klucz MASTER do zamka C-138  
 MASTER key for C-138 lock  
 Ключ MASTER к замку C-138



ZZ-KLMASTER



chrom / chrome / хром



ZnAl, stal / ZnAl, steel / ZnAl, сталь

Zamek Z-338 zatraskowy  
 Square lock Z-338  
 Замок Z-338 с защёлкой

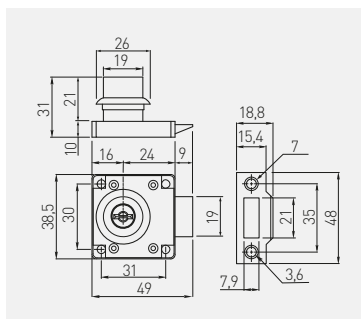

ZZ-ZN-338-01-S



chrom / chrome / хром



ZnAl, stal / ZnAl, steel / ZnAl, сталь

Zamek B-105 bolcowy  
 Pin lock B-105  
 Замок B-105 кнопочный

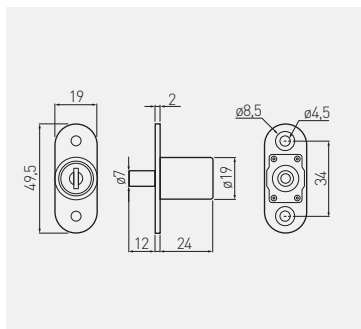

ZZ-B0-105-01-S









chrom / chrome / хром

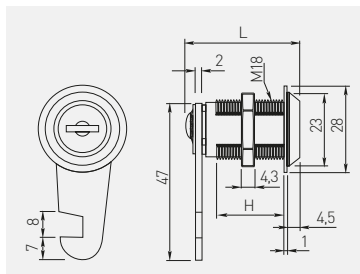

ZnAl, stal / ZnAl, steel / ZnAl, сталь

Zamek Z-103 skrzynkowy  
Box lock Z-103  
Замок Z-103



|                |  |  L<br>mm |  H<br>mm |  |  |
|----------------|---|---|---|---|---|
| ZZ-16-103-01-S |   | 27  | 12  | chrom / chrome / хром   | ZnAl, stal / ZnAl, steel / ZnAl, сталь  |
| ZZ-20-103-01-S |   | 30  | 16,5  |   |   |
| ZZ-30-103-01-S |   | 40  | 26,5  |   |   |

Zamek S-409 do szyb  
Glass door lock S-409  
Замок S-409 для стеклянных фасадов

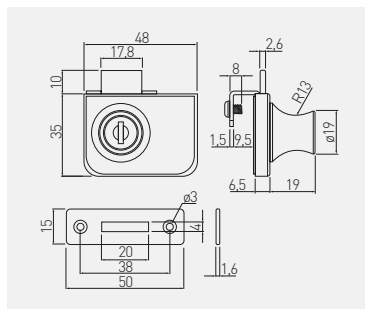

Zastosowanie do szkła 4 - 8 mm  
For 4 - 8 mm glass  
Толщина стекла 4 - 8 мм

|                |  |  |  |
|----------------|---|---|---|
| ZZ-SZ-409-01-S |   | chrom / chrome / хром   | ZnAl, stal / ZnAl, steel / ZnAl, сталь  |

Zamek M-201  
 Lock M-201  
 Замок M-201

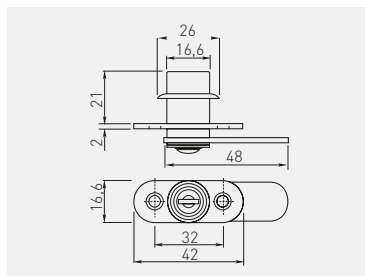

ZZ-M0-201-01-S

chrom / chrome / хром

ZnAl, stal, plastik / ZnAl, steel, plastic / ZnAl, сталь, пластмасса

Zamek Z-202 zaluzjowy  
 Double hook lock Z-202  
 Замок Z-202 жалюзийный

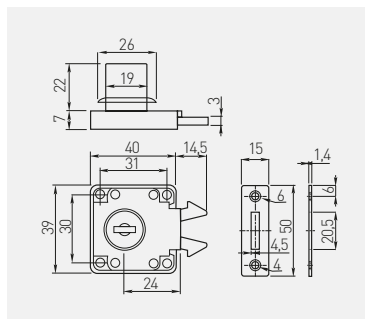

ZZ-Z0-202-01-S

chrom / chrome / хром

ZnAl, stal, plastik / ZnAl, steel, plastic / ZnAl, сталь, пластмасса



Zamek C-288 centralny  
Cabinet drawer lock C-288  
Замок C-288 центральный боковой

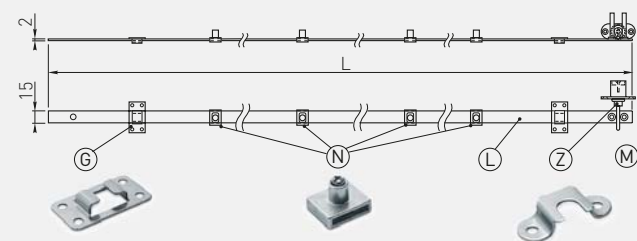

Skład zestawu / Set includes / Состав набора:

- Ⓒ Mocowanie listwy / Slat fixing / Крепление планки
- Ⓓ Blokada szuflady / Drawer locking mechanism / Блокада ящика
- Ⓔ Listwa zamka / Lock slat / Планка замка
- Ⓕ Zamek / Lock / Замок
- Ⓜ Zaczep / Hook / Зацепка

| Model | C5  | C6  | C8  | C1   |
|-------|-----|-----|-----|------|
| L     | 500 | 600 | 800 | 1200 |
| N     | 3   | 3   | 4   | 4    |
| M     | 3   | 3   | 4   | 4    |
| G     | 2   | 2   | 3   | 3    |

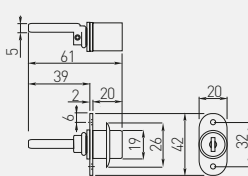
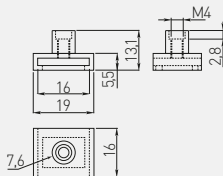
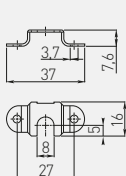

|                |  |  mm |  |  |
|----------------|---|--|---|---|
| ZZ-C5-288-01-S |   | 500  | chrom / chrome / хром   | ZnAl, stal / ZnAl, steel / ZnAl, сталь  |
| ZZ-C6-288-01-S |   | 600  |   |   |
| ZZ-C8-288-01-S |   | 800  |   |   |
| ZZ-C1-288-01-S |   | 1200   |   |   |
| ZZ-SP-105-05   |   | -  | srebrny / silver / серебристый  | stal, plastik / steel, plastic / сталь, пластмасса                                  |
| ZZ-SP-KLMASTER |   | -  | chrom / chrome / хром   |   |

Kratka wentylacyjna  
Plinth vent  
Вентиляционная решётка

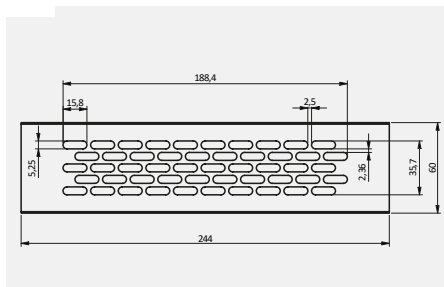





|              |   |  |                                    |
|--------------|---|--|------------------------------------|
| KK-W60245-M0 | przepustowość powietrza<br>– 40 cm <sup>2</sup>       | aluminium / aluminium / алюминий                         | aluminium<br>aluminium<br>алюминий |
| KK-W60245-M1 | air throughput<br>– 40 cm <sup>2</sup>                | biały / white / белый                                    |                                    |
| KK-W60245-M2 | прохождение воздушного<br>потока – 40 см <sup>2</sup> | czarny / black / чёрный                                  |                                    |
| KK-W60245-M6 |   | stal szorstkowana / brushed steel /<br>шлифованная сталь |                                    |

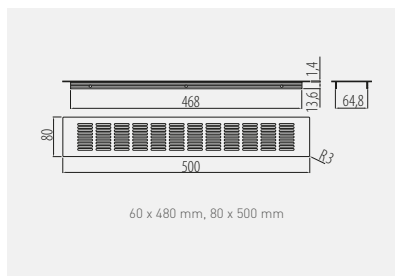

Kratka wentylacyjna D50-80  
Plinth vent D50-80  
Вентиляционная решётка D50-80







|   |  |   |   |
|---|--|---|---|
|  |   |  |  |
| KK-D50-80-06  | przepustowość powietrza – 108 cm <sup>2</sup><br>air throughput – 108 cm <sup>2</sup><br>прохождение воздушного потока – 108 см <sup>2</sup> | stal szczotkowana<br>brushed steel<br>шлифованная сталь                           | aluminium<br>aluminium<br>алюминий  |

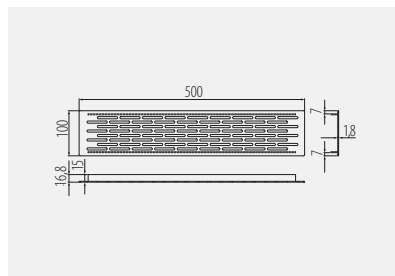

Kratka wentylacyjna D50-100  
Plinth vent D50-100  
Вентиляционная решётка D50-100



|   |  |   |   |
|---|--|---|---|
|  |   |  |  |
| KK-D50100-06  | przepustowość powietrza – 130 cm <sup>2</sup><br>air throughput – 130 cm <sup>2</sup><br>прохождение воздушного потока – 130 см <sup>2</sup> | stal szczotkowana<br>brushed steel<br>шлифованная сталь                             | aluminium<br>aluminium<br>алюминий  |





Kratka wentylacyjna W60  
Plinth vent W60  
Вентиляционная решётка W60

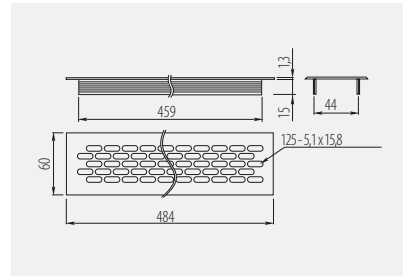

|              |   |                         |                                    |
|--------------|---|-------------------------|------------------------------------|
|              |   |                         |                                    |
| KK-W60800-M0 | przepustowość powietrza – 94 cm <sup>2</sup><br>air throughput – 94 cm <sup>2</sup><br>прохождение воздушного потока – 94 см <sup>2</sup> | szary / gray / серый    | aluminium<br>aluminium<br>алюминий |
| KK-W60800-M1 |   | biały / white / белый   |                                    |
| KK-W60800-M2 |   | czarny / black / чёрный |                                    |



Kratka wentylacyjna W80  
Plinth vent W80  
Вентиляционная решётка W80

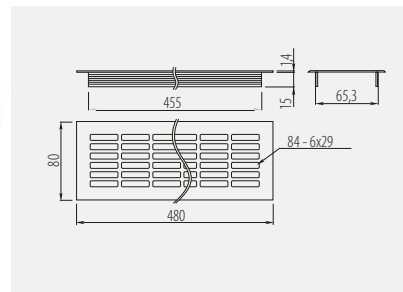





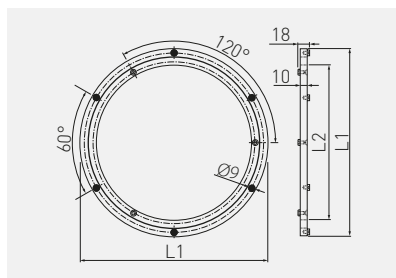

|              |  |                         |                                    |
|--------------|--|-------------------------|------------------------------------|
|              |  |                         |                                    |
| KK-W80800-D0 | przepustowość powietrza – 146 cm <sup>2</sup><br>air throughput – 146 cm <sup>2</sup><br>прохождение воздушного потока – 146 см <sup>2</sup> | szary / gray / серый    | aluminium<br>aluminium<br>алюминий |
| KK-W80800-D1 |  | biały / white / белый   |                                    |
| KK-W80800-D2 |  | czarny / black / чёрный |                                    |



Obrotnica okrągła  
Round swivel bracket  
Круглый поворотный кронштейн







|              |  |  L1<br>mm |  L2<br>mm |  kg<br>↓ |  |  |
|--------------|---|--|--|---|---|---|
| OM-OB0300-05 |   | 300  | 248  | 60  | aluminium<br>aluminium<br>алюминий  | aluminium<br>aluminium<br>алюминий  |
| OM-OB0400-05 |   | 400  | 338  | 100   |   |   |

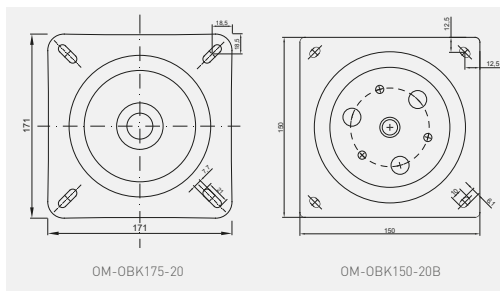

Obrotnica kwadratowa  
Square swivel bracket  
Поворотный кронштейн, квадратный



|               |  |  kg<br>↓ |  |  |
|---------------|---|---|---|---|
| OM-OBK150-20B |   | 50  | czarny<br>black<br>чёрный   | stal<br>steel<br>сталь  |
| OM-OBK175-20* |   | 100   |   |   |





MB

**AKCESORIA DEKORACYJNE  
DECORATIVE ACCESSORIES  
ЛИЦЕВАЯ ФУРНИТУРА**

|  |           |
|--|-----------|
| Uchwyty<br>Handles<br>Ручки                          | 318 – 411 |
| Wieszaki<br>Hooks<br>Крючки                          | 412 – 429 |
| Wsporniki<br>Shelf supports<br>Полкодержатели        | 430 – 437 |
| Nóżki meblowe<br>Furniture legs<br>Мебельные ножки   | 438 – 458 |
| Nogi meblowe<br>Furniture legs<br>Мебельные опоры    | 459 – 475 |
| Rolki meblowe<br>Furniture castors<br>Колесные опоры | 476 – 481 |





Uchwyt EXTEND  
Handle EXTEND  
Ручка EXTEND

NEW

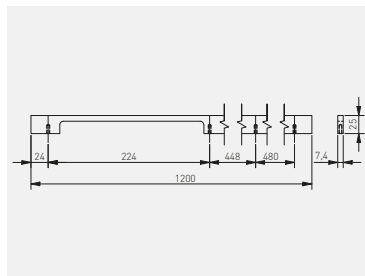

| C<br>mm            | L<br>mm     |  |                         |                                    |
|--------------------|-------------|--|-------------------------|------------------------------------|
|                    |             | czarny mat<br>black matt<br>чёрный матовый | złoty<br>gold<br>золото | aluminium<br>aluminium<br>алюминий |
| <b>224/448/480</b> | <b>1200</b> | UA-EXTEND-1200-20M                         | UA-EXTEND-1200-22       |                                    |

Uchwyt MONZA  
Handle MONZA  
Ручка MONZA

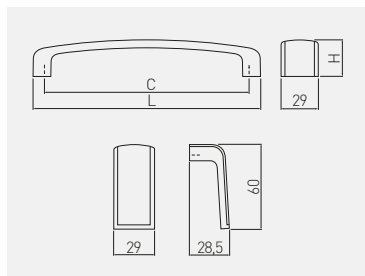

| C<br>mm    | L<br>mm    | H<br>mm     |  |  |  |   |
|------------|------------|-------------|--|--|--|---|
| <b>16</b>  | <b>29</b>  | <b>28,5</b> | stal szorstkowana, chrom<br>brushed steel, chrome<br>шлифованная сталь, хром | biały, chrom<br>white, chrome<br>белый, хром | czarny, chrom<br>black, chrome<br>чёрный, хром | ZnAl,<br>aluminium<br>ZnAl,<br>aluminium<br>ZnAl,<br>алюминий |
|            |            |             | -  | UZ-MONZA16-10                                | -  |   |
| <b>160</b> | <b>178</b> | <b>29</b>   | UZ-MONZA160-06   | UZ-MONZA160-10                               | UZ-MONZA160-20                                 |   |
| <b>256</b> | <b>274</b> | <b>33</b>   | UZ-MONZA256-06   | UZ-MONZA256-10                               | UZ-MONZA256-20                                 |   |
| <b>384</b> | <b>402</b> | <b>34</b>   | UZ-MONZA384-06   | UZ-MONZA384-10                               | UZ-MONZA384-20                                 |   |



Uchwyt MONA  
Handle MONA  
Ручка MONA

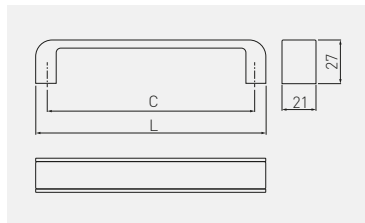

| C<br>mm | L<br>mm |  |  |      |
|---------|---------|--|--|------|
|         |         | chrom, biały<br>chrome, white<br>хром, белый | chrom, czarny<br>chrome, black<br>хром, чёрный | ZnAl |
| 128     | 142     | UZ-MONA-128-01-10                            | UZ-MONA-128-01-20                              |      |
| 192     | 206     | UZ-MONA-192-01-10                            | UZ-MONA-192-01-20                              |      |
| 256     | 270     | UZ-MONA-256-01-10                            | UZ-MONA-256-01-20                              |      |

Uchwyt ARES  
Handle ARES  
Ручка ARES

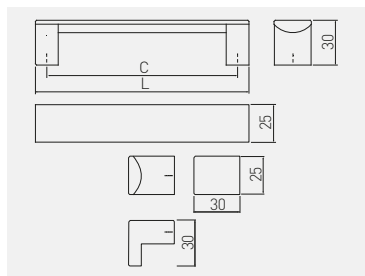

| C<br>mm | L<br>mm |                           |                                    |  |
|---------|---------|---------------------------|------------------------------------|--|
|         |         | czarny<br>black<br>чёрный | aluminium<br>aluminium<br>алюминий |  |
| 96      | 111     | UA-ARS096-20              |                                    |  |
| 128     | 143     | UA-ARS128-20              |                                    |  |
| 160     | 175     | UA-ARS160-20              |                                    |  |
| 192     | 207     | UA-ARS192-20              |                                    |  |
| 224     | 239     | UA-ARS224-20              |                                    |  |

| C<br>mm                | L<br>mm |                           |                                    |  |
|------------------------|---------|---------------------------|------------------------------------|--|
|                        |         | czarny<br>black<br>чёрный | aluminium<br>aluminium<br>алюминий |  |
| 256                    | 271     | UA-ARS256-20              |                                    |  |
| 320                    | 335     | UA-ARS320-20              |                                    |  |
| gatka<br>knob<br>ручка |         | UA-ARSG30-20              |                                    |  |





Uchwyt UZ-G2  
Handle UZ-G2  
Ручка UZ-G2

NEW

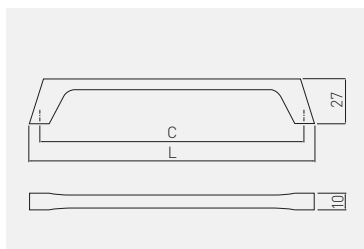

| C<br>mm | L<br>mm |                         |   |  |      |
|---------|---------|-------------------------|---|--|------|
|         |         | chrom<br>chrome<br>хром | stal szczotkowana<br>brushed steel<br>шлифованная сталь | czarny mat<br>black matt<br>чёрный матовый | ZnAl |
| 160     | 172     | UZ-G2-160-01            | UZ-G2-160-06  | UZ-G2-160-20M                              |      |
| 224     | 236     | UZ-G2-224-01            | UZ-G2-224-06  | UZ-G2-224-20M                              |      |

Uchwyt TIVOLI  
Handle TIVOLI  
Ручка TIVOLI

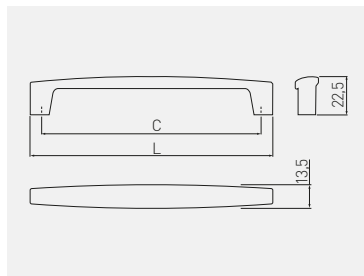

| C<br>mm | L<br>mm |                         |   |                            |      |
|---------|---------|-------------------------|---|----------------------------|------|
|         |         | chrom<br>chrome<br>хром | czarny chrom<br>black chrome<br>чёрный хром | tytan<br>titanium<br>титан | ZnAl |
| 192     | 206     | UZ-TIVOL-192-01         | UZ-TIVOL-192-12                             | UZ-TIVOL-192-13            |      |
| 320     | 334     | UZ-TIVOL-320-01         | UZ-TIVOL-320-12                             | UZ-TIVOL-320-13            |      |

Uchwyt BAGIO  
Handle BAGIO  
Ручка BAGIO

NEW

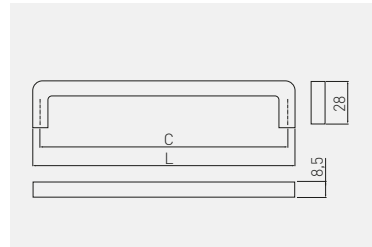

| C<br>mm | L<br>mm |                         |  |                                    |   |      |
|---------|---------|-------------------------|--|------------------------------------|---|------|
|         |         | chrom<br>chrome<br>хром | antyczny mosiądz<br>antique brass<br>античная латунь | aluminium<br>aluminium<br>алюминий | stal szcztokowana<br>brushed steel<br>шлифованная сталь |      |
| 128     | 136     | UZ-BAGIO-128-01         | UZ-BAGIO-128-04                                      | UZ-BAGIO-128-05                    | UZ-BAGIO-128-06   | ZnAl |
| 160     | 168     | UZ-BAGIO-160-01         | UZ-BAGIO-160-04                                      | UZ-BAGIO-160-05                    | UZ-BAGIO-160-06   |      |
| 192     | 200     | UZ-BAGIO-192-01         | UZ-BAGIO-192-04                                      | UZ-BAGIO-192-05                    | UZ-BAGIO-192-06   |      |
| 320     | 328     | UZ-BAGIO-320-01         | UZ-BAGIO-320-04                                      | UZ-BAGIO-320-05                    | UZ-BAGIO-320-06   |      |

| C<br>mm | L<br>mm |   |   |                         |                                 |  |
|---------|---------|---|---|-------------------------|---------------------------------|--|
|         |         | antyczne srebro<br>antique silver<br>античное серебро | tytan szcztokowany<br>brushed titanium<br>шлифованный титан | miedź<br>copper<br>медь | szampan<br>champagne<br>шампань | czarny mat<br>black matt<br>чёрный матовый |
| 128     | 136     | UZ-BAGIO-128-07                                       | UZ-BAGIO-128-11   | UZ-BAGIO-128-15         | UZ-BAGIO-128-90                 | UZ-BAGIO-128-20M                           |
| 160     | 168     | UZ-BAGIO-160-07                                       | UZ-BAGIO-160-11   | UZ-BAGIO-160-15         | UZ-BAGIO-160-90                 | UZ-BAGIO-160-20M                           |
| 192     | 200     | UZ-BAGIO-192-07                                       | UZ-BAGIO-192-11   | UZ-BAGIO-192-15         | UZ-BAGIO-192-90                 | UZ-BAGIO-192-20M                           |
| 320     | 328     | UZ-BAGIO-320-07                                       | UZ-BAGIO-320-11   | UZ-BAGIO-320-15         | UZ-BAGIO-320-90                 | UZ-BAGIO-320-20M                           |



MODERN

Uchwyt ANCONA  
Handle ANCONA  
Ручка ANCONA

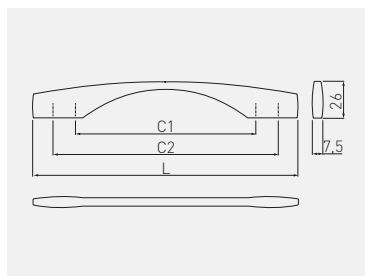

| C1<br>mm | C2<br>mm | L<br>mm |                         |                                    |   |      |
|----------|----------|---------|-------------------------|------------------------------------|---|------|
|          |          |         | chrom<br>chrome<br>хром | aluminium<br>aluminium<br>алюминий | stal szczotkowana<br>brushed steel<br>шлифованная сталь | ZnAl |
| 128      | 160      | 190     | UZ-ANCON-128-01         | UZ-ANCON-128-05                    | UZ-ANCON-128-06   |      |
| 192      | 224      | 254     | UZ-ANCON-192-01         | UZ-ANCON-192-05                    | UZ-ANCON-192-06   |      |
| 256      | 288      | 318     | UZ-ANCON-256-01         | UZ-ANCON-256-05                    | UZ-ANCON-256-06   |      |

Uchwyt KATANIA  
Handle KATANIA  
Ручка KATANIA

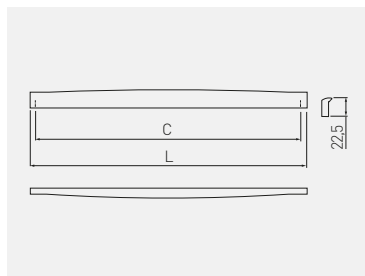

| C<br>mm | L<br>mm |                         |   |      |
|---------|---------|-------------------------|---|------|
|         |         | chrom<br>chrome<br>хром | czarny chrom<br>black chrome<br>чёрный хром | ZnAl |
| 320     | 334     | UZ-KATAN-320-01         | UZ-KATAN-320-12                             |      |

Uchwyt UZ-40  
Handle UZ-40  
Ручка UZ-40

NEW

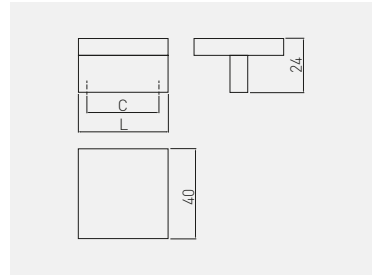

| C<br>mm | L<br>mm |                         |                          |                                    |   |   |      |
|---------|---------|-------------------------|--------------------------|------------------------------------|---|---|------|
|         |         | chrom<br>chrome<br>хром | satyna<br>satin<br>сатин | aluminium<br>aluminium<br>алюминий | stal szczerkowana<br>brushed steel<br>шлифованная сталь | czarny matt<br>black matt<br>чёрный матовый | ZnAl |
| 32      | 40      | UZ-40-032-01            | UZ-40-032-02             | UZ-40-032-05                       | UZ-40-032-06  | UZ-40-032-20M                               |      |

Uchwyt UZ-55  
Handle UZ-55  
Ручка UZ-55

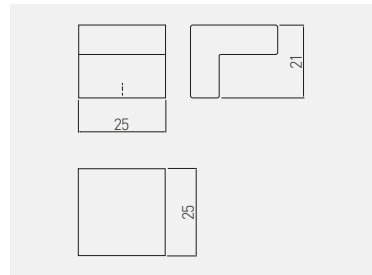

|                        | L<br>mm |                                    |      |
|------------------------|---------|------------------------------------|------|
|                        |         | aluminium<br>aluminium<br>алюминий | ZnAl |
| gatka<br>knob<br>ручка | 25      | UZ-55-025-05                       |      |

MODERN

Uchwyt UZ-60  
Handle UZ-60  
Ручка UZ-60

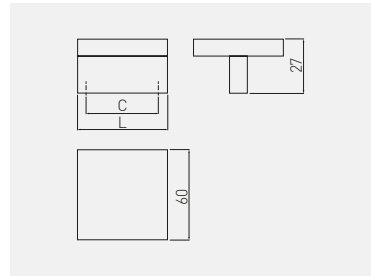

| C<br>mm | L<br>mm |                         |      |
|---------|---------|-------------------------|------|
|         |         | chrom<br>chrome<br>хром | ZnAl |
| 32      | 60      | UZ-60-032-01            |      |

Uchwyt UZ-133  
Handle UZ-133  
Ручка UZ-133

NEW

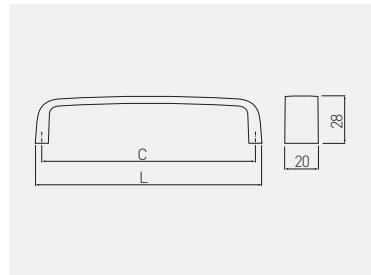

| C<br>mm | L<br>mm |                         |                          |                                    |   |  |      |
|---------|---------|-------------------------|--------------------------|------------------------------------|---|--|------|
|         |         | chrom<br>chrome<br>хром | satyna<br>satin<br>сатин | aluminium<br>aluminium<br>алюминий | stal szczotkowana<br>brushed steel<br>шлифованная сталь | czarny mat<br>black matt<br>чёрный матовый | ZnAl |
| 128     | 135     | UZ-133128-01            | UZ-133128-02             | UZ-133128-05                       | UZ-133128-06  | UZ-133128-20M                              |      |

Uchwyt MODENA  
Handle MODENA  
Ручка MODENA

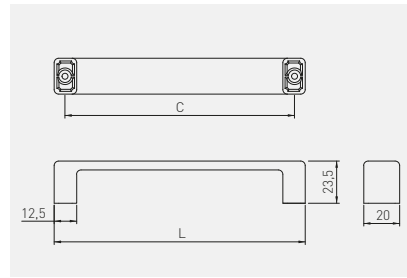

| C<br>mm | L<br>mm | chrom<br>chrome<br>хром | aluminium<br>aluminium<br>алюминий | stal szcztokowana<br>brushed steel<br>шлифованная сталь | czarny mat<br>black matt<br>чёрный матовый | ZnAl |
|---------|---------|-------------------------|------------------------------------|---|--|------|
| 128     | 140     | UZ-MODEN-128-01         | UZ-MODEN-128-05                    | UZ-MODEN-128-06   | UZ-MODEN-128-20M                           | ZnAl |
| 160     | 172     | UZ-MODEN-160-01         | UZ-MODEN-160-05                    | UZ-MODEN-160-06   | UZ-MODEN-160-20M                           |      |
| 192     | 204     | UZ-MODEN-192-01         | UZ-MODEN-192-05                    | UZ-MODEN-192-06   | UZ-MODEN-192-20M                           |      |



Uchwyt UZ-334  
Handle UZ-334  
Ручка UZ-334

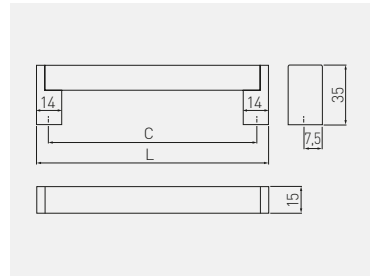

| C   | L   |   |  |
|-----|-----|---|--|
| mm  | mm  |   |  |
|     |     | stal szczotkowana<br>brushed steel<br>шлифованная сталь | ZnAl, stal<br>ZnAl, steel<br>ZnAl, сталь |
| 128 | 144 | UZ-334128-06  |  |
| 160 | 175 | UZ-334160-06  |  |
| 192 | 206 | UZ-334192-06  |  |
| 256 | 272 | UZ-334256-06  |  |
| 320 | 335 | UZ-334320-06  |  |

Uchwyt UZ-336  
Handle UZ-336  
Ручка UZ-336

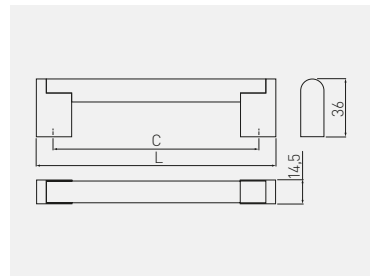

| C   | L   |   |  |
|-----|-----|---|--|
| mm  | mm  |   |  |
|     |     | stal szczotkowana<br>brushed steel<br>шлифованная сталь | ZnAl, stal<br>ZnAl, steel<br>ZnAl, сталь |
| 128 | 148 | UZ-336128-06  |  |
| 160 | 182 | UZ-336160-06  |  |
| 192 | 213 | UZ-336192-06  |  |
| 256 | 276 | UZ-336256-06  |  |
| 320 | 340 | UZ-336320-06  |  |
| 416 | 436 | UZ-336416-06  |  |
| 480 | 500 | UZ-336480-06  |  |



Uchwyt UZ-682  
Handle UZ-682  
Ручка UZ-682

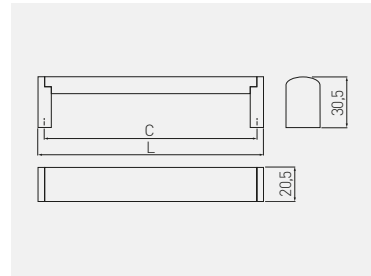

| C<br>mm | L<br>mm |   |  |  |
|---------|---------|---|--|--|
|         |         | stal szorstkowana<br>brushed steel<br>шлифованная сталь | stal, ZnAl<br>steel, ZnAl<br>сталь, ZnAl |  |
| 128     | 136     | UZ-682128-06  |  |  |
| 160     | 170     | UZ-682160-06  |  |  |
| 192     | 209     | UZ-682192-06  |  |  |
| 224     | 232     | UZ-682224-06  |  |  |

| C<br>mm | L<br>mm |   |  |  |
|---------|---------|---|--|--|
|         |         | stal szorstkowana<br>brushed steel<br>шлифованная сталь | stal, ZnAl<br>steel, ZnAl<br>сталь, ZnAl |  |
| 256     | 266     | UZ-682256-06  |  |  |
| 320     | 329     | UZ-682320-06  |  |  |
| 416     | 425     | UZ-682416-06  |  |  |
| 480     | 489     | UZ-682480-06  |  |  |

Uchwyt MILANO  
Handle MILANO  
Ручка MILANO

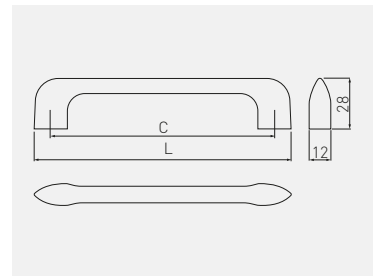

| C<br>mm                | L<br>mm |                         |                                    |   |  |      |
|------------------------|---------|-------------------------|------------------------------------|---|--|------|
| C                      | L       | chrom<br>chrome<br>хром | aluminium<br>aluminium<br>алюминий | stal szorstkowana<br>brushed steel<br>шлифованная сталь | czarny mat<br>black matt<br>чёрный матовый | ZnAl |
| 128                    | 146     | UZ-MILAN-128-01         | UZ-MILAN-128-05                    | UZ-MILAN-128-06   | UZ-MILAN-128-20M                           |      |
| 256                    | 274     | UZ-MILAN-256-01         | UZ-MILAN-256-05                    | UZ-MILAN-256-06   | UZ-MILAN-256-20M                           |      |
| gatka<br>knob<br>ручка |         | -                       | -                                  | -   | GZ-MILAN-32-20M                            |      |

Uchwyt OCTAVIO  
Handle OCTAVIO  
Ручка OCTAVIO

NEW

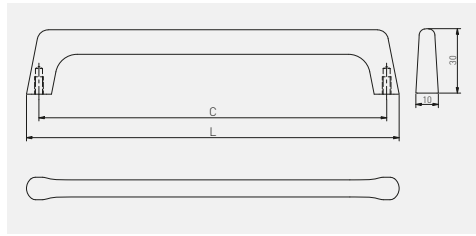

C  
mm

L  
mm



| C   | L   | chrom<br>chrome<br>хром | mosiądz<br>brass<br>латунь | stal szczotkowana<br>brushed steel<br>шлифованная сталь | złoty szczotkowany<br>brushed gold<br>матовое золото | czarny mat<br>black matt<br>чёрный матовый | ZnAl |
|-----|-----|-------------------------|----------------------------|---|--|--|------|
| 128 | 139 | UZ-OCTAVIO-128-01       | UZ-OCTAVIO-128-03          | UZ-OCTAVIO-128-06                                       | UZ-OCTAVIO-128-18                                    | UZ-OCTAVIO-128-20M                         |      |
| 160 | 171 | UZ-OCTAVIO-160-01       | UZ-OCTAVIO-160-03          | UZ-OCTAVIO-160-06                                       | UZ-OCTAVIO-160-18                                    | UZ-OCTAVIO-160-20M                         |      |
| 192 | 203 | UZ-OCTAVIO-192-01       | UZ-OCTAVIO-192-03          | UZ-OCTAVIO-192-06                                       | UZ-OCTAVIO-192-18                                    | UZ-OCTAVIO-192-20M                         |      |



Uchwyt CAPRI  
Handle CAPRI  
Ручка CAPRI

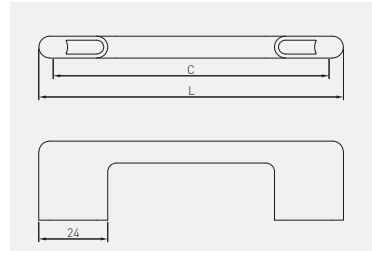

**C**  
mm

**L**  
mm



| C   | L   | chrom<br>chrome<br>хром | satyna<br>satin<br>сатин | aluminium<br>aluminium<br>алюминий | stal szorstkowana<br>brushed steel<br>шлифованная сталь | czarny mat<br>black matt<br>чёрный матовый |      |
|-----|-----|-------------------------|--------------------------|------------------------------------|---|--|------|
| 96  | 106 | UZ-CAPRI-96-01          | UZ-CAPRI-96-02           | UZ-CAPRI-96-05                     | UZ-CAPRI-96-06  | -  |      |
| 128 | 138 | UZ-CAPRI-128-01         | UZ-CAPRI-128-02          | UZ-CAPRI-128-05                    | UZ-CAPRI-128-06   | UZ-CAPRI-128-20M                           | ZnAl |
| 160 | 170 | UZ-CAPRI-160-01         | UZ-CAPRI-160-02          | UZ-CAPRI-160-05                    | UZ-CAPRI-160-06   | UZ-CAPRI-160-20M                           |      |
| 192 | 202 | UZ-CAPRI-192-01         | UZ-CAPRI-192-02          | UZ-CAPRI-192-05                    | UZ-CAPRI-192-06   | UZ-CAPRI-192-20M                           |      |
| 256 | 266 | UZ-CAPRI-256-01         | UZ-CAPRI-256-02          | UZ-CAPRI-256-05                    | UZ-CAPRI-256-06   | UZ-CAPRI-256-20M                           |      |
| 320 | 330 | UZ-CAPRI-320-01         | UZ-CAPRI-320-02          | UZ-CAPRI-320-05                    | UZ-CAPRI-320-06   | -  |      |



Uchwyt UZ-819  
Handle UZ-819  
Ручка UZ-819

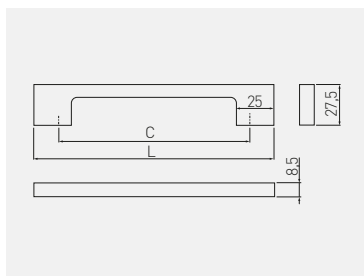

| C   | L   | chrom<br>chrome<br>хром | satyna<br>satin<br>сатин | aluminium<br>aluminium<br>алюминий | stal szcztokowana<br>brushed steel<br>шлифованная сталь | antyczne srebro<br>antique silver<br>античное серебро | biały<br>white<br>белый | ZnAl |
|-----|-----|-------------------------|--------------------------|------------------------------------|---|---|-------------------------|------|
| 96  | 129 | UZ-819096-01            | UZ-819096-02             | UZ-819096-05                       | UZ-819096-06  | UZ-819096-07  | UZ-819096-10            |      |
| 128 | 161 | UZ-819128-01            | UZ-819128-02             | UZ-819128-05                       | UZ-819128-06  | UZ-819128-07  | UZ-819128-10            |      |
| 160 | 193 | UZ-819160-01            | UZ-819160-02             | UZ-819160-05                       | UZ-819160-06  | UZ-819160-07  | UZ-819160-10            |      |
| 192 | 225 | UZ-819192-01            | UZ-819192-02             | UZ-819192-05                       | UZ-819192-06  | UZ-819192-07  | UZ-819192-10            |      |
| 256 | 289 | UZ-819256-01            | UZ-819256-02             | UZ-819256-05                       | UZ-819256-06  | UZ-819256-07  | UZ-819256-10            |      |
| 320 | 353 | UZ-819320-01            | UZ-819320-02             | UZ-819320-05                       | UZ-819320-06  | UZ-819320-07  | UZ-819320-10            |      |



| C   | L   | czarny chrom<br>black chrome<br>чёрный хром | antyczna miedź<br>antique copper<br>античная медь | miedź<br>copper<br>медь | złoty mosiądz<br>gold brass<br>золотая латунь | czarny<br>black<br>чёрный | ZnAl |
|-----|-----|---|---|-------------------------|---|---------------------------|------|
| 96  | 129 | UZ-819096-12                                | UZ-819096-14                                      | -                       | -   | UZ-819096-20              |      |
| 128 | 161 | UZ-819128-12                                | UZ-819128-14                                      | UZ-819128-15            | UZ-819128-16                                  | UZ-819128-20              |      |
| 160 | 193 | UZ-819160-12                                | UZ-819160-14                                      | UZ-819160-15            | UZ-819160-16                                  | UZ-819160-20              |      |
| 192 | 225 | UZ-819192-12                                | UZ-819192-14                                      | UZ-819192-15            | UZ-819192-16                                  | UZ-819192-20              |      |
| 256 | 289 | UZ-819256-12                                | UZ-819256-14                                      | UZ-819256-15            | UZ-819256-16                                  | UZ-819256-20              |      |
| 320 | 353 | UZ-819320-12                                | UZ-819320-14                                      | -                       | -   | UZ-819320-20              |      |



antyczna miedź  
antique copper  
античная медь



miedź  
copper  
медь

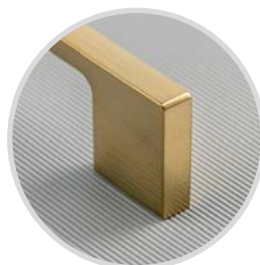

złoty mosiądz  
gold brass  
золотая латунь



Gatka SPOT  
Knob SPOT  
Ручка SPOT

NEW

MODERN

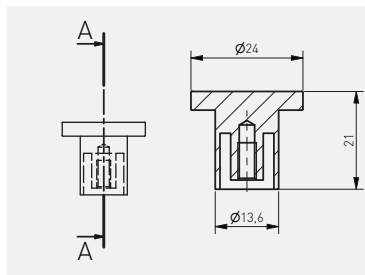

|   | stal szcztokowana<br>brushed steel<br>шлифованная сталь | złoty szcztokowany<br>brushed gold<br>матовое золото | czarny matt<br>black matt<br>чёрный матовый |      |
|---|---|--|---|------|
| <b>gatka</b><br><b>knob</b><br><b>ручка</b> | GZ-SPOT-1-06  | GZ-SPOT-1-18   | GZ-SPOT-1-20M                               | ZnAl |

Uchwyt CLEO  
Handle CLEO  
Ручка CLEO

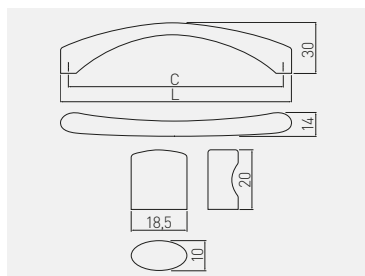

|            |            | chrom<br>chrome<br>хром | aluminium<br>aluminium<br>алюминий | stal szcztokowana<br>brushed steel<br>шлифованная сталь |      |
|------------|------------|-------------------------|------------------------------------|---|------|
| <b>128</b> | <b>137</b> | UZ-CLEO-128-01          | UZ-CLEO-128-05                     | UZ-CLEO-128-06  | ZnAl |
| <b>160</b> | <b>169</b> | UZ-CLEO-160-01          | UZ-CLEO-160-05                     | UZ-CLEO-160-06  |      |
| <b>192</b> | <b>201</b> | UZ-CLEO-192-01          | UZ-CLEO-192-05                     | UZ-CLEO-192-06  |      |





Uchwyt PRATO  
Handle PRATO  
Ручка PRATO

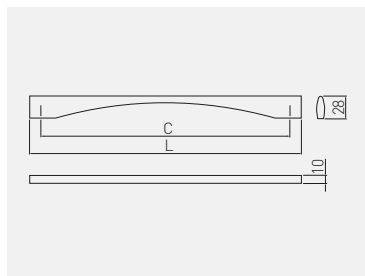

| C<br>mm | L<br>mm |                         |   |      |
|---------|---------|-------------------------|---|------|
|         |         | chrom<br>chrome<br>хром | stal szczotkowana<br>brushed steel<br>шлифованная сталь | ZnAl |
| 160     | 189     | UZ-PRATO-160-01         | UZ-PRATO-160-06   |      |
| 320     | 349     | UZ-PRATO-320-01         | UZ-PRATO-320-06   |      |

Uchwyt UA-B311  
Handle UA-B311  
Ручка UA-B311

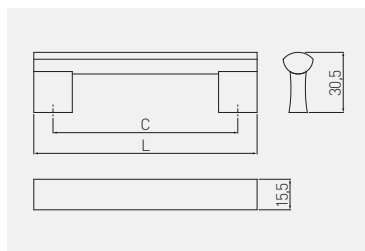

| C<br>mm | L<br>mm |                         |                                    |                           |                                    |
|---------|---------|-------------------------|------------------------------------|---------------------------|------------------------------------|
|         |         | chrom<br>chrome<br>хром | aluminium<br>aluminium<br>алюминий | czarny<br>black<br>чёрный | aluminium<br>aluminium<br>алюминий |
| 96      | 116     | UA-B31109601*           | UA-B0-311096                       | UA-B0-311096-20M          |                                    |
| 128     | 148     | UA-B31112801            | UA-B0-311128                       | UA-B0-311128-20M          |                                    |
| 160     | 180     | UA-B31116001            | UA-B0-311160                       | UA-B0-311160-20M          |                                    |
| 192     | 212     | UA-B31119201            | UA-B0-311192                       | UA-B0-311192-20M          |                                    |
| 224     | 244     | UA-B31122401            | UA-B0-311224                       | UA-B0-311224-20M          |                                    |
| 256     | 276     | UA-B31125601            | UA-B0-311256                       | UA-B0-311256-20M          |                                    |
| 288     | 307     | UA-B31128801*           | UA-B0-311288                       | UA-B0-311288-20M*         |                                    |
| 320     | 340     | UA-B31132001*           | UA-B0-311320                       | UA-B0-311320-20M          |                                    |
| 480     | 500     | UA-B31148001*           | UA-B0-311480                       | UA-B0-311480-20M*         |                                    |

\* Produkt dostępny na indywidualne zamówienie / Available for special orders / Товар доступен под заказ



Uchwyt UA-B337  
Handle UA-B337  
Ручка UA-B337

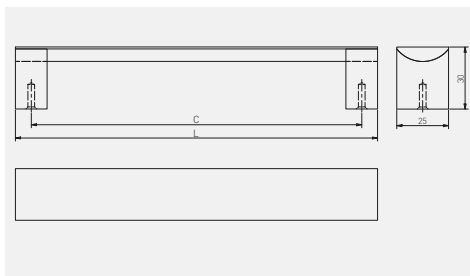

| <br>C<br>mm | <br>L<br>mm |  |  |
|--|--|---|---|
|  |  | aluminium<br>aluminium<br>алюминий  | aluminium<br>aluminium<br>алюминий  |
| 128  | 143  | UA-B0-337128  |   |
| 160  | 175  | UA-B0-337160  |   |
| 192  | 207  | UA-B0-337192  |   |
| 224  | 239  | UA-B0-337224  |   |
| 256  | 271  | UA-B0-337256  |   |
| 320  | 335  | UA-B0-337320  |   |



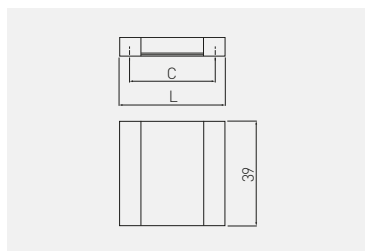

Uchwyt UA-114  
Handle UA-114  
Ручка UA-114

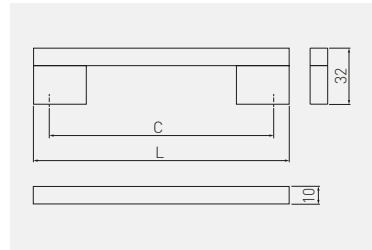

| <br>C<br>mm | <br>L<br>mm |  |  |
|--|--|---|---|
|  |  | aluminium<br>aluminium<br>алюминий  | aluminium<br>aluminium<br>алюминий  |
| 32   | 39   | UA-AA-114-05  |   |

Uchwyt UA-18  
Handle UA-18  
Ручка UA-18





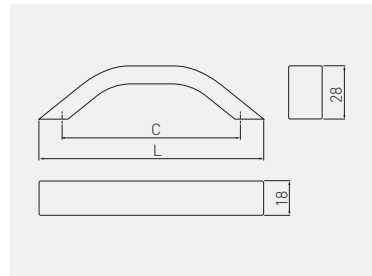

|  C<br>mm |  L<br>mm |  |  |
|---|---|---|---|
|   |   | chrom<br>chrome<br>хром   | aluminium<br>aluminium<br>алюминий  |
| <b>128</b>  | <b>146</b>  | UA-A18128-01  | UA-18-128146  |
| <b>160</b>  | <b>178</b>  | UA-A18160-01  | UA-18-160178  |
| <b>192</b>  | <b>210</b>  | UA-A18192-01  | UA-18-192210  |
| <b>224</b>  | <b>242</b>  | UA-A18224-01  | UA-18-224242  |
| <b>256</b>  | <b>274</b>  | UA-A18256-01  | UA-18-256274  |
| <b>320</b>  | <b>338</b>  | UA-A18320-01  | UA-18-320338  |
| <b>400</b>  | <b>418</b>  | -   | UA-18-400418  |

aluminium  
aluminium  
алюминий





Uchwyt UA-313  
Handle UA-313  
Ручка UA-313

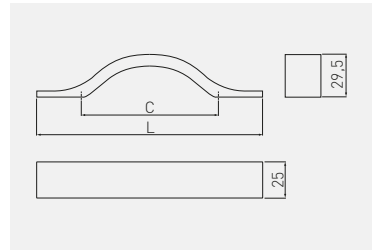

|  C<br>mm |  L<br>mm |  |  |
|---|---|---|---|
|   |   | aluminium<br>aluminium<br>алюминий  | aluminium<br>aluminium<br>алюминий  |
| <b>128</b>  | <b>150</b>  | UA-00-313128  |   |
| <b>160</b>  | <b>182</b>  | UA-00-313160  |   |
| <b>192</b>  | <b>214</b>  | UA-00-313192  |   |





Uchwyt UA-319  
Handle UA-319  
Ручка UA-319

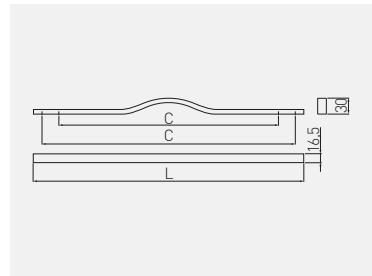

|  C<br>mm |  L<br>mm |  |  |
|---|---|---|---|
|   |   | aluminium<br>aluminium<br>алюминий  | aluminium<br>aluminium<br>алюминий  |
| <b>96</b>   | <b>158</b>  | UA-00-319096  |   |
| <b>128</b>  | <b>189</b>  | UA-00-319128  |   |
| <b>160</b>  | <b>231</b>  | UA-00-319160  |   |

Uchwyt DOPPIO  
Handle DOPPIO  
Ручка DOPPIO



|  C<br>mm |  L<br>mm |  |  |
|---|---|---|---|
|   |   | chrom, aluminium<br>chrome, aluminium<br>хром, алюминий                             | aluminium<br>aluminium<br>алюминий  |
| <b>192 / 224</b>  | <b>256</b>  | UA-DOPPIO192-01   |   |
| <b>416 / 480</b>  | <b>512</b>  | UA-DOPPIO416-01   |   |

Uchwyt VITO  
Handle VITO  
Ручка VITO

NEW

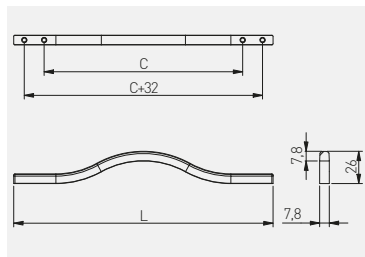

C  
mm

L  
mm



| C<br>mm | L<br>mm | chrom<br>chrome<br>хром | aluminium<br>aluminium<br>алюминий | antyczne srebro<br>antique silver<br>античное серебро | ZnAl |
|---------|---------|-------------------------|------------------------------------|---|------|
| 160     | 210     | UZ-VITO-160-01          | UZ-VITO-160-05                     | UZ-VITO-160-07  | ZnAl |
| 288     | 340     | UZ-VITO-288-01          | UZ-VITO-288-05                     | UZ-VITO-288-07  |      |

C  
mm

L  
mm



| C<br>mm | L<br>mm | czarny chrom<br>black chrome<br>чёрный хром | złoty mosiądz<br>gold brass<br>золотая латунь | czarny mat<br>black matt<br>чёрный матовый | ZnAl |
|---------|---------|---|---|--|------|
| 160     | 210     | UZ-VITO-160-12                              | UZ-VITO-160-16                                | UZ-VITO-160-20M                            | ZnAl |
| 288     | 340     | UZ-VITO-288-12                              | UZ-VITO-288-16                                | UZ-VITO-288-20M                            |      |

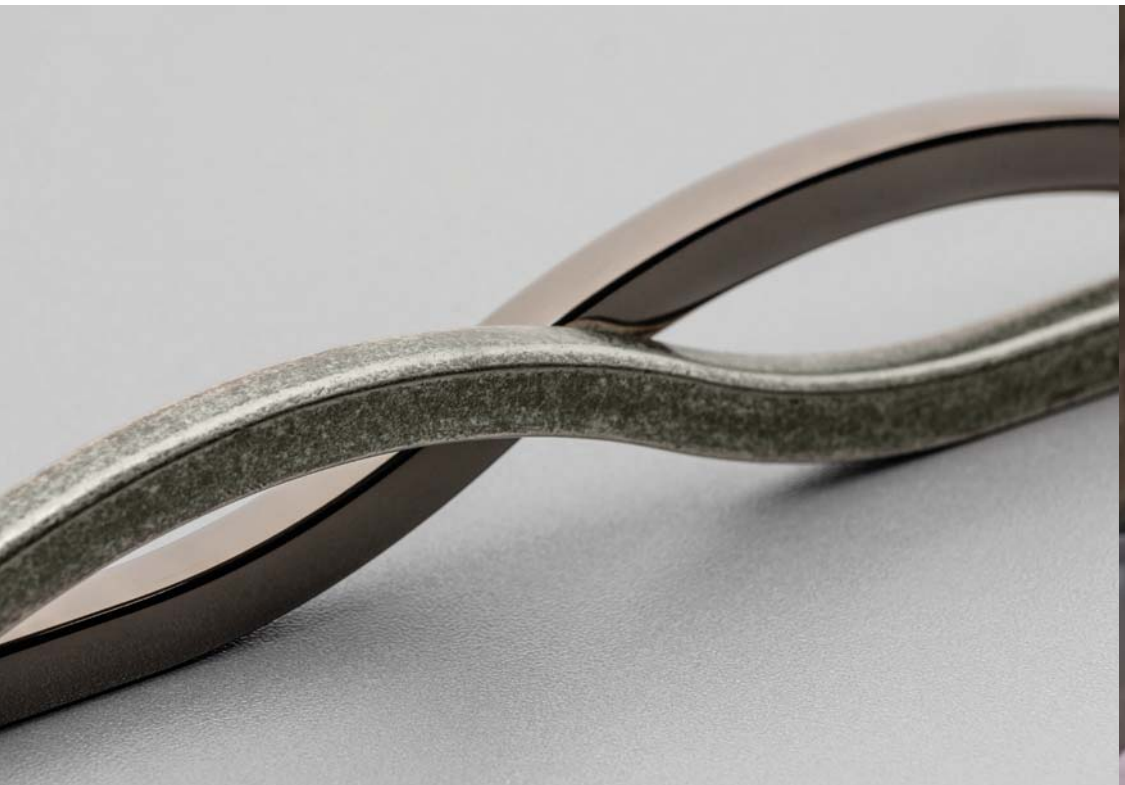

Gatka DUNE  
Knob DUNE  
Ручка DUNE

NEW

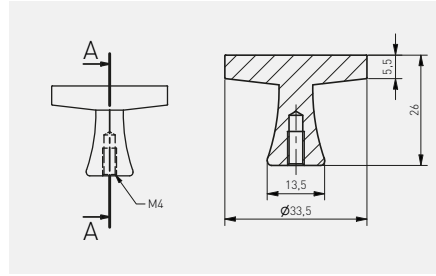

|   | stal szczotkowana<br>brushed steel<br>шлифованная сталь | złoty mosiądz<br>gold brass<br>золотая латунь | czarny mat<br>black matt<br>чёрный матовый |      |
|---|---|---|--|------|
| <b>gatka</b><br><b>knob</b><br><b>ручка</b> | GZ-DUNE-1-06  | GZ-DUNE-1-16                                  | GZ-DUNE-1-20M                              | ZnAl |

MODERN



Uchwyt FLAVIO  
Handle FLAVIO  
Ручка FLAVIO

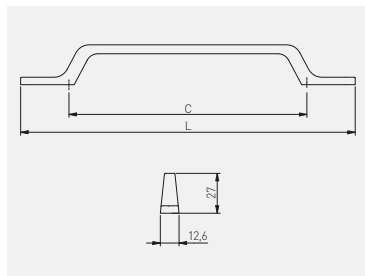

| C<br>mm    | L<br>mm    |                         |   |   |  |      |
|------------|------------|-------------------------|---|---|--|------|
|            |            | chrom<br>chrome<br>хром | stal szcztokowana<br>brushed steel<br>шлифованная сталь | złoty mosiądz<br>golden brass<br>золотая латунь | czarny mat<br>black matt<br>чёрный матовый | ZnAl |
| <b>96</b>  | <b>161</b> | UZ-FLAVIO-96-01         | UZ-FLAVIO-96-06   | UZ-FLAVIO-96-16                                 | UZ-FLAVIO-96-20M                           |      |
| <b>128</b> | <b>193</b> | UZ-FLAVIO-128-01        | UZ-FLAVIO-128-06  | UZ-FLAVIO-128-16                                | UZ-FLAVIO-128-20M                          |      |
| <b>160</b> | <b>225</b> | UZ-FLAVIO-160-01        | UZ-FLAVIO-160-06  | UZ-FLAVIO-160-16                                | UZ-FLAVIO-160-20M                          |      |

Uchwyt THIN  
Handle THIN  
Ручка THIN

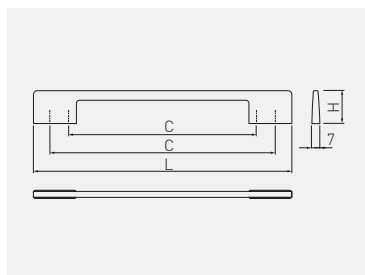

| C<br>mm        | L<br>mm    | H<br>mm   |                         |                                    |   |      |
|----------------|------------|-----------|-------------------------|------------------------------------|---|------|
|                |            |           | chrom<br>chrome<br>хром | aluminium<br>aluminium<br>алюминий | stal szcztokowana<br>brushed steel<br>шлифованная сталь | ZnAl |
| <b>96/128</b>  | <b>156</b> | <b>24</b> | UZ-TH096128-01          | UZ-TH096128-05                     | UZ-TH096128-06  |      |
| <b>160/192</b> | <b>220</b> | <b>28</b> | UZ-TH160192-01          | UZ-TH160192-05                     | UZ-TH160192-06  |      |
| <b>288/320</b> | <b>348</b> | <b>28</b> | UZ-TH288320-01          | -                                  | UZ-TH288320-06  |      |

Uchwyt UA-337  
Handle UA-337  
Ручка UA-337

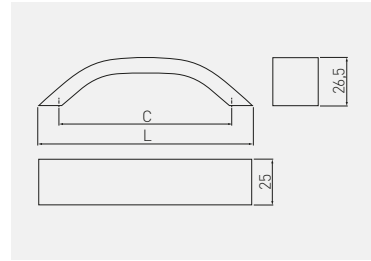

| C<br>mm    | L<br>mm    |  |  |                                    |
|------------|------------|---|---|------------------------------------|
|            |            | aluminium<br>aluminium<br>алюминий  | czarny<br>black<br>чёрный   | aluminium<br>aluminium<br>алюминий |
| <b>96</b>  | <b>116</b> | UA-00-337096  | UA-00-337096-20M  |                                    |
| <b>128</b> | <b>146</b> | UA-00-337128  | UA-00-337128-20M  |                                    |
| <b>160</b> | <b>180</b> | UA-00-337160  | UA-00-337160-20M  |                                    |
| <b>192</b> | <b>212</b> | UA-00-337192  | UA-00-337192-20M  |                                    |
| <b>224</b> | <b>244</b> | UA-00-337224  | UA-00-337224-20M  |                                    |
| <b>256</b> | <b>275</b> | UA-00-337256  | UA-00-337256-20M  |                                    |
| <b>320</b> | <b>340</b> | UA-00-337320  | UA-00-337320-20M  |                                    |



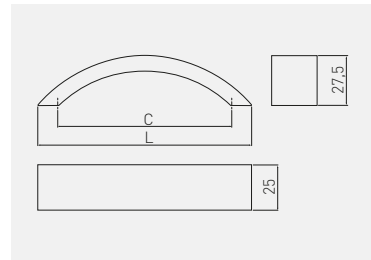

Uchwyt UA-338  
Handle UA-338  
Ручка UA-338

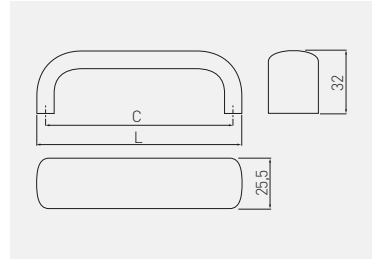

| C<br>mm    | L<br>mm    |  |  |                                    |
|------------|------------|---|---|------------------------------------|
|            |            | aluminium<br>aluminium<br>алюминий  |   | aluminium<br>aluminium<br>алюминий |
| <b>128</b> | <b>137</b> | UA-00-338128  |   |                                    |
| <b>160</b> | <b>169</b> | UA-00-338160  |   |                                    |

Uchwyt UA-340  
Handle UA-340  
Ручка UA-340



|  C<br>mm |  L<br>mm |  |  |
|---|---|---|---|
|   |   | aluminium<br>aluminium<br>алюминий  | aluminium<br>aluminium<br>алюминий  |
| <b>128</b>  | <b>137</b>  | UA-00-340128  |   |
| <b>160</b>  | <b>169</b>  | UA-00-340160  |   |
| <b>192</b>  | <b>201</b>  | UA-00-340192  |   |
| <b>224</b>  | <b>233</b>  | UA-00-340224  |   |
| <b>256</b>  | <b>265</b>  | UA-00-340256  |   |
| <b>320</b>  | <b>329</b>  | UA-00-340320  |   |

Uchwyt UA-347  
Handle UA-347  
Ручка UA-347

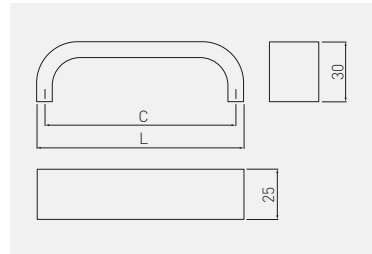

|  C<br>mm |  L<br>mm |  |  |
|---|---|---|---|
|   |   | aluminium<br>aluminium<br>алюминий  | aluminium<br>aluminium<br>алюминий  |
| <b>128</b>  | <b>136</b>  | UA-00-347128  |   |
| <b>160</b>  | <b>168</b>  | UA-00-347160  |   |
| <b>192</b>  | <b>200</b>  | UA-00-347192  |   |
| <b>224</b>  | <b>232</b>  | UA-00-347224  |   |
| <b>256</b>  | <b>264</b>  | UA-00-347256  |   |
| <b>320</b>  | <b>328</b>  | UA-00-347320  |   |



Uchwyt CALABRIA  
Handle CALABRIA  
Ручка CALABRIA

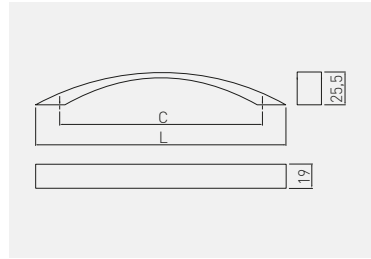

| C<br>mm | L<br>mm |                         |   |      |
|---------|---------|-------------------------|---|------|
| 160     | 195     | chrom<br>chrome<br>хром | stal szczotkowana<br>brushed steel<br>шлифованная сталь | ZnAl |
| 192     | 224     | UZ-CALABRIA160-01       | UZ-CALABRIA160-06                                       |      |
| 224     | 258     | UZ-CALABRIA192-01       | UZ-CALABRIA192-06                                       |      |
|         |         | UZ-CALABRIA224-01       | UZ-CALABRIA224-06                                       |      |

CLASSIC

Uchwyt GENUA  
Handle GENUA  
Ручка GENUA

NEW

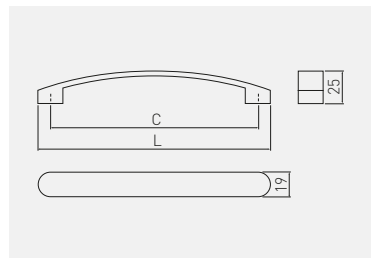

| C<br>mm | L<br>mm |                         |                          |                                    |   |      |
|---------|---------|-------------------------|--------------------------|------------------------------------|---|------|
| 128     | 148     | chrom<br>chrome<br>хром | satyna<br>satin<br>сатин | aluminium<br>aluminium<br>алюминий | czarny matt<br>black matt<br>чёрный матовый | ZnAl |
|         |         | UZ-GENUA128-01          | UZ-GENUA128-02           | UZ-GENUA128-05                     | UZ-GENUA128-20M                             |      |
| 160     | 180     | UZ-GENUA160-01          | UZ-GENUA160-02           | UZ-GENUA160-05                     | UZ-GENUA160-20M                             |      |

Uchwyt G0  
Handle G0  
Ручка G0

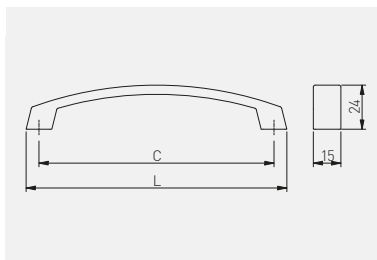

| C<br>mm    | L<br>mm    |                         |                                    |   |      |
|------------|------------|-------------------------|------------------------------------|---|------|
|            |            | chrom<br>chrome<br>хром | aluminium<br>aluminium<br>алюминий | stal szczotkowana<br>brushed steel<br>шлифованная сталь | ZnAl |
| <b>128</b> | <b>142</b> | UZ-G0-128-01            | UZ-G0-128-05                       | UZ-G0-128-06  |      |
| <b>160</b> | <b>174</b> | UZ-G0-160-01            | UZ-G0-160-05                       | UZ-G0-160-06  |      |
| <b>192</b> | <b>206</b> | UZ-G0-192-01            | UZ-G0-192-05                       | UZ-G0-192-06  |      |
| <b>256</b> | <b>270</b> | UZ-G0-256-01            | UZ-G0-256-05                       | UZ-G0-256-06  |      |

Uchwyt UZ-G1  
Handle UZ-G1  
Ручка UZ-G1

NEW

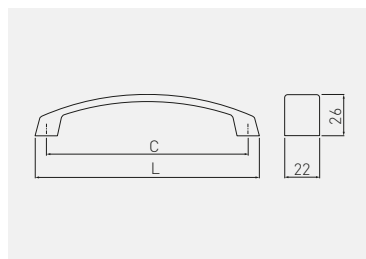

| C<br>mm    | L<br>mm    |                         |                                    |   |                            |  |      |
|------------|------------|-------------------------|------------------------------------|---|----------------------------|--|------|
|            |            | chrom<br>chrome<br>хром | aluminium<br>aluminium<br>алюминий | stal szczotkowana<br>brushed steel<br>шлифованная сталь | tytan<br>titanium<br>титан | czarny mat<br>black matt<br>чёрный матовый | ZnAl |
| <b>128</b> | <b>142</b> | UZ-G1-128-01            | UZ-G1-128-05                       | UZ-G1-128-06  | UZ-G1-128-13               | UZ-G1-128-20M                              |      |
| <b>160</b> | <b>174</b> | UZ-G1-160-01            | UZ-G1-160-05                       | UZ-G1-160-06  | UZ-G1-160-13               | UZ-G1-160-20M                              |      |
| <b>192</b> | <b>206</b> | UZ-G1-192-01            | UZ-G1-192-05                       | UZ-G1-192-06  | UZ-G1-192-13               | UZ-G1-192-20M                              |      |
| <b>256</b> | <b>270</b> | UZ-G1-256-01            | UZ-G1-256-05                       | UZ-G1-256-06  | UZ-G1-256-13               | UZ-G1-256-20M                              |      |
| <b>320</b> | <b>334</b> | UZ-G1-320-01            | UZ-G1-320-05                       | UZ-G1-320-06  | UZ-G1-320-13               | UZ-G1-320-20M                              |      |
| <b>416</b> | <b>430</b> | UZ-G1-416-01            | UZ-G1-416-05                       | UZ-G1-416-06  | -                          | -  |      |

Uchwyt NORD  
Handle NORD  
Ручка NORD

NEW

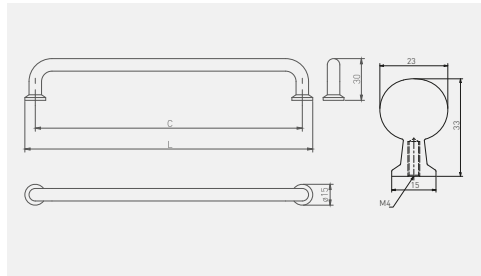

| C<br>mm                | L<br>mm | mosiądz<br>brass<br>латунь | złoty szcztokowany<br>brushed gold<br>матовое золото | czarny mat<br>black matt<br>чёрный матовый | ZnAl |
|------------------------|---------|----------------------------|--|--|------|
| 128                    | 146     | UZ-NORD-128-03             | UZ-NORD-128-18                                       | UZ-NORD-128-20M                            |      |
| 160                    | 174,5   | UZ-NORD-160-03             | UZ-NORD-160-18                                       | UZ-NORD-160-20M                            |      |
| 192                    | 212     | UZ-NORD-192-03             | UZ-NORD-192-18                                       | UZ-NORD-192-20M                            |      |
| 320                    | 334     | UZ-NORD-320-03             | UZ-NORD-320-18                                       | UZ-NORD-320-20M                            |      |
| gatka<br>knob<br>ручка |         | GZ-NORD-1-03               | GZ-NORD-1-18   | GZ-NORD-1-20M                              |      |

CLASSIC



Uchwyt VENICE  
Handle VENICE  
Ручка VENICE

NEW

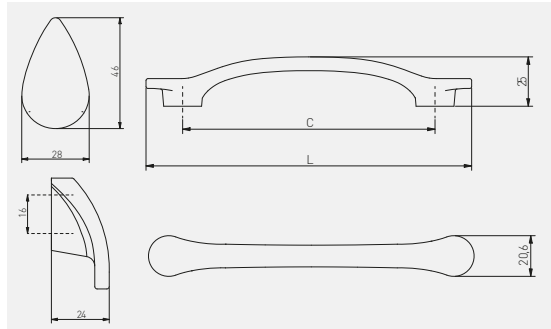
C  
mmL  
mm





| C                      | L   | szampan<br>champagne<br>шампань | czarny mat<br>black matt<br>чёрный матовый | ZnAl |
|------------------------|-----|---------------------------------|--|------|
| 128                    | 165 | UZ-VENICE-128-90                | UZ-VENICE-128-20M                          |      |
| galka<br>knob<br>ручка |     | GZ-VENICE-1-90                  | GZ-VENICE-1-20M                            |      |

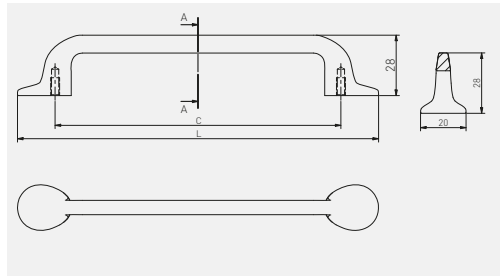

Uchwyt FABRICIO  
Handle FABRICIO  
Ручка FABRICIO

NEW



|  C<br>mm |  L<br>mm |  |  |      |
|---|---|---|---|------|
|   |   | złoty szczotkowany<br>brushed gold<br>матовое золото                              | czarny mat<br>black matt<br>чёрный матовый  |      |
| 128   | 161   | UZ-FABRICIO-128-18  | UZ-FABRICIO-128-20M   | ZnAl |
| 192   | 225   | UZ-FABRICIO-192-18  | UZ-FABRICIO-192-20M   |      |
| 320   | 353   | UZ-FABRICIO-320-18  | UZ-FABRICIO-320-20M   |      |

CLASSIC



Uchwyt OTTO  
Handle OTTO  
Ручка OTTO

NEW

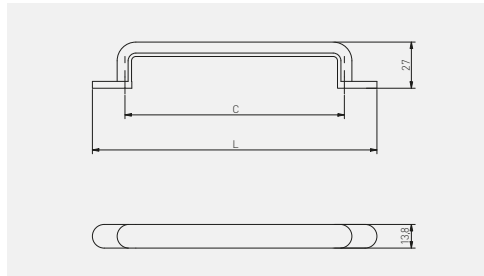

| C<br>mm | L<br>mm |   |                                 |  |      |
|---------|---------|---|---------------------------------|--|------|
|         |         | stal szcztokowana<br>brushed steel<br>шлифованная сталь | szampan<br>champagne<br>шампань | czarny mat<br>black matt<br>чёрный матовый | ZnAl |
| 128     | 166     | UZ-OTTO-128-06  | UZ-OTTO-128-90                  | UZ-OTTO-128-20M                            |      |
| 160     | 198     | UZ-OTTO-160-06  | UZ-OTTO-160-90                  | UZ-OTTO-160-20M                            |      |



Uchwyt EVER  
Handle EVER  
Ручка EVER

NEW

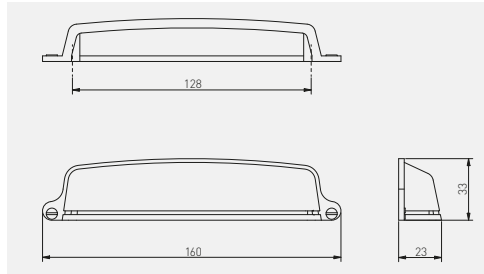

| C<br>mm | L<br>mm |                                 |  |      |
|---------|---------|---------------------------------|--|------|
|         |         | szampan<br>champagne<br>шампань | czarny mat<br>black matt<br>чёрный матовый | ZnAl |
| 128     | 160     | UZ-EVER-128-90                  | UZ-EVER-128-20M                            |      |

CLASSIC



Gatka POINT  
 Knob POINT  
 Ручка POINT

NEW

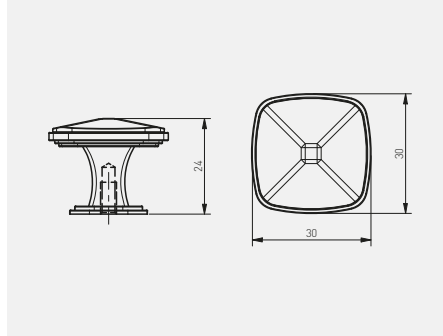

CLASSIC



|   |   |  |  |      |
|---|---|--|--|------|
|   | stal szczotkowana<br>brushed steel<br>шлифованная сталь | złoty szczotkowany<br>brushed gold<br>матовое золото | czarny mat<br>black matt<br>чёрный матовый |      |
| <b>gatka</b><br><b>knob</b><br><b>ручка</b> | GZ-POINT-1-06   | GZ-POINT-1-18  | GZ-POINT-1-20M                             | ZnAl |





Gatka LORENA  
Knob LORENA  
Ручка LORENA

NEW

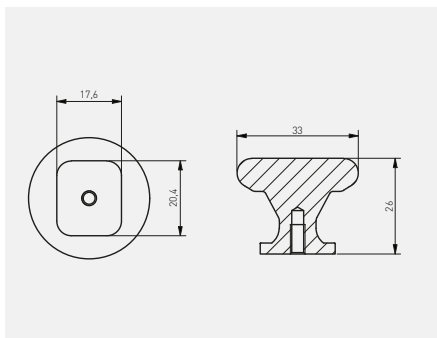

|   | złoty szczotkowany<br>brushed gold<br>матовое золото | czarny mat<br>black matt<br>чёрный матовый | szczotkowany antracyt<br>brushed anthracite<br>матовое антрацит |      |
|---|--|--|---|------|
| <b>gatka</b><br><b>knob</b><br><b>ручка</b> | GZ-LORENA-1-18                                       | GZ-LORENA-1-20M                            | GZ-LORENA-1-21  | ZnAl |

CLASSIC

Uchwyt STEP  
Handle STEP  
Ручка STEP

NEW

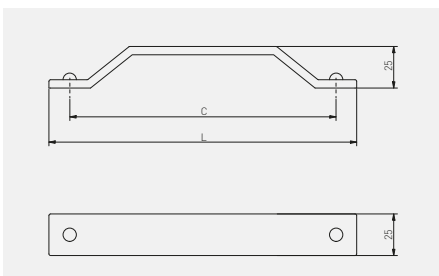

|            |  C<br>mm |  L<br>mm |  |  |
|------------|---|---|---|---|
|            |   |   | antyczne srebro<br>antique silver<br>античное серебро                               | czarny mat<br>black matt<br>чёрный матовый  |
| <b>160</b> | <b>185</b>  | UZ-STEP-160-07  | UZ-STEP-160-20M   | ZnAl  |

Uchwyt FLOW  
Handle FLOW  
Ручка FLOW

NEW

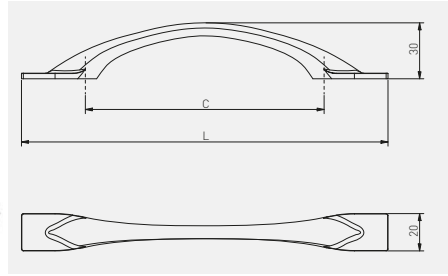

| C<br>mm | L<br>mm |   |                                 |  |      |
|---------|---------|---|---------------------------------|--|------|
|         |         | stal szczotkowana<br>brushed steel<br>шлифованная сталь | szampan<br>champagne<br>шампань | czarny mat<br>black matt<br>чёрный матовый | ZnAl |
| 128     | 200     | UZ-FLOW-128-06  | UZ-FLOW-128-90                  | UZ-FLOW-128-20M                            |      |
| 192     | 270     | UZ-FLOW-192-06  | UZ-FLOW-192-90                  | UZ-FLOW-192-20M                            |      |



Uchwyt STILO  
Handle STILO  
Ручка STILO

NEW

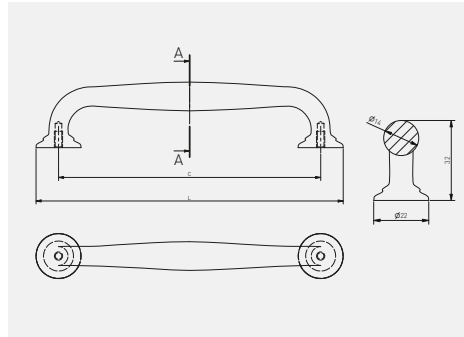

C  
mm

L  
mm



|                        |     | złoty szczotkowany<br>brushed gold<br>матовое золото | czarny mat<br>black matt<br>чёрный матовый |      |
|------------------------|-----|--|--|------|
| 128                    | 147 | UZ-STILO-128-18                                      | UZ-STILO-128-20M                           | ZnAl |
| 160                    | 179 | UZ-STILO-160-18                                      | UZ-STILO-160-20M                           |      |
| gatka<br>knob<br>ручка |     | GZ-STILO-1-18  | GZ-STILO-1-20M                             |      |

CLASSIC



Uchwyt STRUCTURE  
Handle STRUCTURE  
Ручка STRUCTURE

NEW

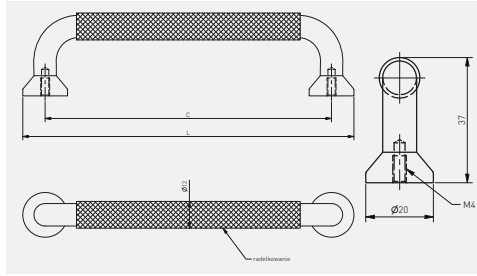

| C<br>mm                | L<br>mm |  |  |
|------------------------|---------|--|---|
|                        |         | czarny mat<br>black matt<br>чёрный матовый |   |
| 128                    | 147     | UA-STRUCTURE-128-20M                       | Aluminium<br>aluminium<br>aluminio  |
| 192                    | 212     | UA-STRUCTURE-192-20M                       |   |
| gatka<br>кноп<br>ручка |         | GA-STRUCTURE-1-20M                         |   |



Uchwyt UZ-01  
Handle UZ-01  
Ручка UZ-01

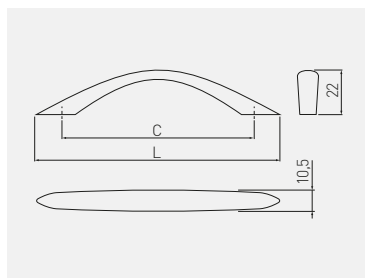

| C<br>mm | L<br>mm |                         |  |                                    |  |
|---------|---------|-------------------------|---|------------------------------------|---|
| 96      | 121     | chrom<br>chrome<br>хром | satyna<br>satin<br>сатин  | aluminium<br>aluminium<br>алюминий | ZnAl  |
| 128     | 158     | UZ-01-096-01            | UZ-01-096-02  | UZ-01-096-05                       |   |
|         |         | UZ-01-128-01            | UZ-01-128-02  | UZ-01-128-05                       |   |

Uchwyt UZ-05  
Handle UZ-05  
Ручка UZ-05

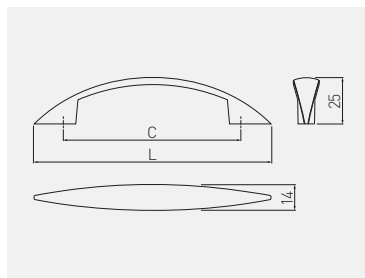

| C<br>mm | L<br>mm |                         |  |                                    |  |
|---------|---------|-------------------------|---|------------------------------------|---|
| 96      | 132     | chrom<br>chrome<br>хром | satyna<br>satin<br>сатин  | aluminium<br>aluminium<br>алюминий | ZnAl  |
| 128     | 164     | UZ-05-096-01            | UZ-05-096-02  | UZ-05-096-05                       |   |
|         |         | UZ-05-128-01            | UZ-05-128-02  | UZ-05-128-05                       |   |

Uchwyt UZ-06  
Handle UZ-06  
Ручка UZ-06

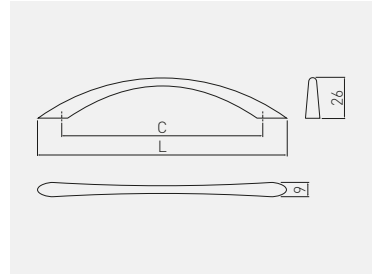

| C<br>mm | L<br>mm |                         |  |                                    |  |
|---------|---------|-------------------------|---|------------------------------------|---|
|         |         | chrom<br>chrome<br>хром | satyna<br>satin<br>сатин  | aluminium<br>aluminium<br>алюминий | ZnAl  |
| 128     | 164     | UZ-06-128-01            | UZ-06-128-02  | UZ-06-128-05                       |   |

Uchwyt UZ-07  
Handle UZ-07  
Ручка UZ-07

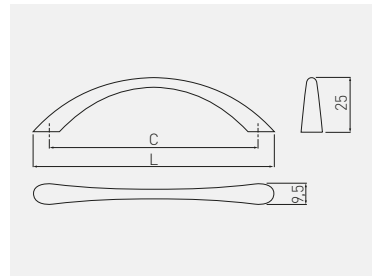

| C<br>mm | L<br>mm |                         |  |                                    |  |
|---------|---------|-------------------------|---|------------------------------------|---|
|         |         | chrom<br>chrome<br>хром | satyna<br>satin<br>сатин  | aluminium<br>aluminium<br>алюминий | ZnAl  |
| 96      | 111     | UZ-07-096-01            | UZ-07-096-02  | UZ-07-096-05                       |   |

Uchwyt UZ-Z10  
Handle UZ-Z10  
Ручка UZ-Z10

NEW

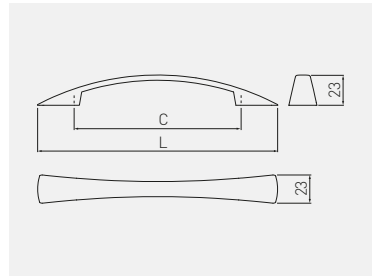

| C<br>mm    | L<br>mm    |                         |                          |                                    |  |      |
|------------|------------|-------------------------|--------------------------|------------------------------------|--|------|
|            |            | chrom<br>chrome<br>хром | satyna<br>satin<br>сатин | aluminium<br>aluminium<br>алюминий | czarny mat<br>black matt<br>чёрный матовый | ZnAl |
| <b>96</b>  | <b>138</b> | UZ-Z10096-01            | UZ-Z10096-02             | UZ-Z10096-05                       | UZ-Z10096-20M                              |      |
| <b>128</b> | <b>184</b> | UZ-Z10128-01            | UZ-Z10128-02             | UZ-Z10128-05                       | UZ-Z10128-20M                              |      |

Uchwyt UZ-13  
Handle UZ-13  
Ручка UZ-13

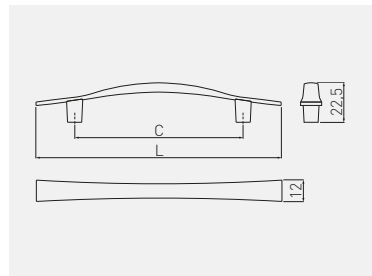

| C<br>mm   | L<br>mm    |                         |                          |                                    |  |      |
|-----------|------------|-------------------------|--------------------------|------------------------------------|--|------|
|           |            | chrom<br>chrome<br>хром | satyna<br>satin<br>сатин | aluminium<br>aluminium<br>алюминий |  | ZnAl |
| <b>96</b> | <b>140</b> | UZ-13-096-01            | UZ-13-096-02             | UZ-13-096-05                       |  |      |

CLASSIC

Uchwyt UZ-14  
Handle UZ-14  
Ручка UZ-14

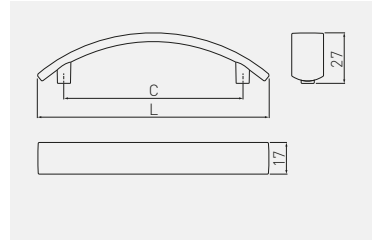

| C<br>mm | L<br>mm |                         |                          |                                    |      |
|---------|---------|-------------------------|--------------------------|------------------------------------|------|
|         |         | chrom<br>chrome<br>хром | satyna<br>satin<br>сатин | aluminium<br>aluminium<br>алюминий | ZnAl |
| 96      | 138     | UZ-14-096-01            | UZ-14-096-02             | UZ-14-096-05                       |      |
| 128     | 184     | UZ-14-128-01            | UZ-14-128-02             | UZ-14-128-05                       |      |
|         |         |                         |                          |                                    |      |

Uchwyt CAMAIO  
Handle CAMAIO  
Ручка CAMAIO

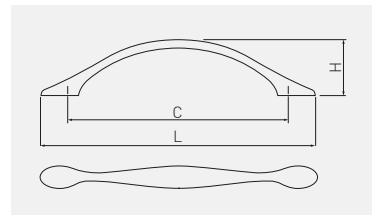

NEW

| C<br>mm | L<br>mm | H<br>mm |                         |                          |   |  |
|---------|---------|---------|-------------------------|--------------------------|---|--|
|         |         |         | chrom<br>chrome<br>хром | satyna<br>satin<br>сатин | stal szcztokowana<br>brushed steel<br>шлифованная сталь | antyczny miedz<br>szcztokowany<br>antique brushed brass<br>античная шлифованная латунь |
| 96      | 126     | 23      | UZ-CAMAI-96-01          | UZ-CAMAI-96-02           | UZ-CAMAI-96-06  | UZ-CAMAI-96-09   |
| 128     | 160     | 32,5    | UZ-CAMAI-128-01         | UZ-CAMAI-128-02          | UZ-CAMAI-128-06   | UZ-CAMAI-128-09  |

| C<br>mm | L<br>mm | H<br>mm |  |  |                                |   |
|---------|---------|---------|--|--|--------------------------------|---|
|         |         |         | biały mat<br>white matt<br>белый матовый | czarny mat<br>black matt<br>чёрный матовый | szampa<br>champagne<br>шампань | czarny chrom<br>black chrome<br>чёрный хром |
| 96      | 126     | 23      | UZ-CAMAI-96-10M                          | UZ-CAMAI-96-20M                            | UZ-CAMAI-96-90                 | UZ-CAMAI-96-12                              |
| 128     | 160     | 32,5    | UZ-CAMAI-128-10M                         | UZ-CAMAI-128-20M                           | UZ-CAMAI-128-90                | UZ-CAMAI-128-12                             |



Gatka BERGAMO  
Knob BERGAMO  
Ручка BERGAMO

NEW

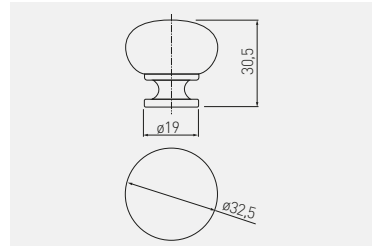

|                                 |                         |                          |                                    |   |                        |
|---------------------------------|-------------------------|--------------------------|------------------------------------|---|------------------------|
|                                 | chrom<br>chrome<br>хром | satyna<br>satin<br>сатин | aluminium<br>aluminium<br>алюминий | stal szcztokowana<br>brushed steel<br>шлифованная сталь | stal<br>steel<br>сталь |
| <b>gatka<br/>knob<br/>ручка</b> | GS-BERGA-1-01           | GS-BERGA-1-02            | GS-BERGA-1-05                      | GS-BERGA-1-06   |                        |



|                                 |                         |  |   |                                 |                        |
|---------------------------------|-------------------------|--|---|---------------------------------|------------------------|
|                                 | biały<br>white<br>белый | czarny mat<br>black matt<br>чёрный матовый | czarny chrom<br>black chrome<br>чёрный хром | szampań<br>champagne<br>шампань | stal<br>steel<br>сталь |
| <b>gatka<br/>knob<br/>ручка</b> | GS-BERGA-1-10           | GS-BERGA-1-20M                             | GS-BERGA-1-12                               | GS-BERGA-1-90                   |                        |



Gatka UDINE  
Knob UDINE  
Ручка UDINE

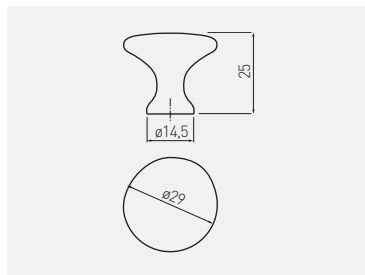

|   |                         |                          |                                    |   |      |
|---|-------------------------|--------------------------|------------------------------------|---|------|
|   | chrom<br>chrome<br>хром | satyna<br>satin<br>сатин | aluminium<br>aluminium<br>алюминий | stal szczotkowana<br>brushed steel<br>шлифованная сталь | ZnAl |
| <b>gatka</b><br><b>knob</b><br><b>ручка</b> | GZ-UDINE-1-01           | GZ-UDINE-1-02            | GZ-UDINE-1-05                      | GZ-UDINE-1-06   |      |



|   |  |   |  |      |
|---|--|---|--|------|
|   | biały mat<br>white matt<br>белый матовый | czarny chrom<br>black chrome<br>чёрный хром | czarny mat<br>black matt<br>чёрный матовый | ZnAl |
| <b>gatka</b><br><b>knob</b><br><b>ручка</b> | GZ-UDINE-1-10M                           | GZ-UDINE-1-12N                              | GZ-UDINE-1-20M                             |      |

Gatka TERNI  
Knob TERNI  
Ручка TERNI

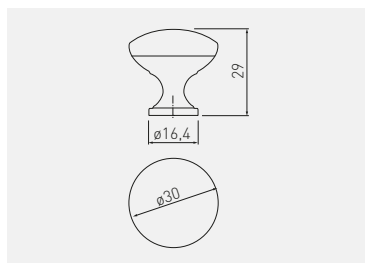



|   |                         |                          |                                    |   |   |
|---|-------------------------|--------------------------|------------------------------------|---|---|
|   | chrom<br>chrome<br>хром | satyna<br>satin<br>сатин | aluminium<br>aluminium<br>алюминий | stal szczotkowana<br>brushed steel<br>шлифованная сталь | antyczny mosiądz szczotkowany<br>antique brushed brass<br>античная шлифованная латунь |
| <b>gatka</b><br><b>knob</b><br><b>ручка</b> | GZ-TERNI-1-01           | GZ-TERNI-1-02            | GZ-TERNI-1-05                      | GZ-TERNI-1-06   | GZ-TERNI-1-09   |

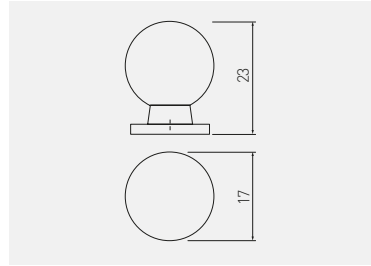

|   |                         |   |                         |   |  |      |
|---|-------------------------|---|-------------------------|---|--|------|
|   | biały<br>white<br>белый | czarny chrom<br>black chrome<br>чёрный хром | miedź<br>copper<br>медь | złoty mosiądz<br>gold brass<br>золотая латунь | czarny mat<br>black matt<br>чёрный матовый | ZnAl |
| <b>gatka</b><br><b>knob</b><br><b>ручка</b> | GZ-TERNI-1-10           | GZ-TERNI-1-12                               | GZ-TERNI-1-15           | GZ-TERNI-1-16                                 | GZ-TERNI-1-20M                             |      |

Gatka GZ-1155  
Knob GZ-1155  
Ручка GZ-1155



|   |   |   |
|---|---|---|
|   |  |  |
|   | chrom<br>chrome<br>хром   | ZnAl  |
| <b>gatka</b><br><b>knob</b><br><b>ручка</b> | GZ-WP1155-01  |   |

Gatka GZ-ZH  
Knob GZ-ZH  
Ручка GZ-ZH

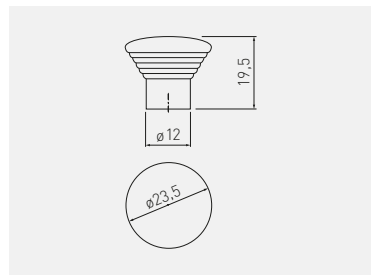

|   |   |   |
|---|---|---|
|  |  |  |
|   | aluminium<br>aluminium<br>алюминий  | ZnAl  |
| <b>gatka</b><br><b>knob</b><br><b>ручка</b>   | GZ-ZH-011-05A   |   |

# Uchwyt RELING RS

## Handle RELING RS

### Ручка RELING RS

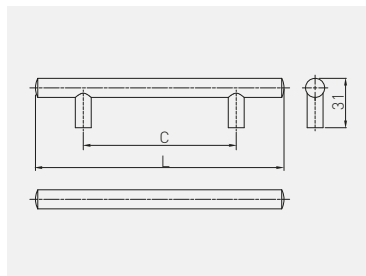

| C<br>mm | L<br>mm | chrom<br>chrome<br>хром | satyna<br>satin<br>сатин | aluminium<br>aluminium<br>алюминий | stal szcztkowana<br>brushed steel<br>шлифованная сталь | antyczna miedz<br>antique copper<br>античная медь |                        |
|---------|---------|-------------------------|--------------------------|------------------------------------|--|---|------------------------|
| 96      | 156     | RS-156096-01            | RS-156096-02             | RS-156096-05                       | RS-156096-06   | RS-156096-14                                      | stal<br>steel<br>сталь |
| 128     | 188     | RS-188128-01            | RS-188128-02             | RS-188128-05                       | RS-188128-06   | RS-188128-14                                      |                        |
| 160     | 220     | RS-220160-01            | RS-220160-02             | RS-220160-05                       | RS-220160-06   | RS-220160-14                                      |                        |
| 192     | 272     | RS-272192-01            | RS-272192-02             | RS-272192-05                       | RS-272192-06   | RS-272192-14                                      |                        |
| 224     | 304     | RS-304224-01            | RS-304224-02             | RS-304224-05                       | RS-304224-06   | RS-304224-14                                      |                        |
| 256     | 336     | RS-336256-01            | RS-336256-02             | RS-336256-05                       | RS-336256-06   | RS-336256-14                                      |                        |
| 288     | 368     | RS-368288-01            | RS-368288-02             | RS-368288-05                       | RS-368288-06   | RS-368288-14*                                     |                        |
| 320     | 400     | RS-400320-01            | RS-400320-02             | RS-400320-05                       | RS-400320-06   | RS-400320-14                                      |                        |

| C<br>mm | L<br>mm | stal szcztkowana<br>brushed steel<br>шлифованная сталь | czarny mat<br>black matt<br>чёрный матовый |                        |
|---------|---------|--|--|------------------------|
| 96      | 156     | -  | ID-RS-E-15696-20M*                         | stal<br>steel<br>сталь |
| 128     | 188     | -  | ID-RS-E-188128-20M*                        |                        |
| 160     | 220     | ID-RS-E-220160-06*                                     | ID-RS-E-220160-20M*                        |                        |
| 192     | 272     | ID-RS-E-272192-06*                                     | ID-RS-E-272192-20M*                        |                        |
| 224     | 304     | ID-RS-E-304224-06*                                     | ID-RS-E-304224-20M*                        |                        |
| 256     | 336     | ID-RS-E-336256-06*                                     | ID-RS-E-336256-20M*                        |                        |
| 288     | 368     | ID-RS-E-368288-06*                                     | ID-RS-E-368288-20M*                        |                        |
| 320     | 400     | ID-RS-E-400320-06*                                     | ID-RS-E-400320-20M*                        |                        |

Na indywidualne zamówienie dostępne również rozstawy:  
352, 384, 416, 480, 512, 544, 576, 608, 640, 672, 704, 736,  
768, 800 (mm).

Other sizes available as special-order items:  
352, 384, 416, 480, 512, 544, 576, 608, 640, 672, 704, 736,  
768, 800 (mm).

Под заказ доступны ручки с межцентровым расстоянием:  
352, 384, 416, 480, 512, 544, 576, 608, 640, 672, 704, 736,  
768, 800 (mm).

antyczna miedz  
antique copper  
античная медь



\* Produkt dostępny na indywidualne zamówienie / Available for special orders / Товар доступен под заказ

Istnieje możliwość zakupu dodatkowych rozstawów i kolorów na zamówienie indywidualne / Additional spacings and colours can be purchased on individual order / По индивидуальному заказу можно приобрести дополнительные размеры и цвета



Uchwyt TRIEST  
Handle TRIEST  
Ручка TRIEST

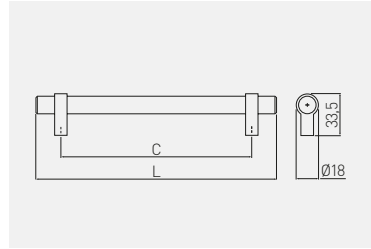

| C<br>mm | L<br>mm |  |  |
|---------|---------|---|---|
|         |         | stal szczotkowana<br>brushed steel<br>шлифованная сталь                           |   |
| 96      | 136     | RS-TRIES-96-06  | stal, ZnAl<br>steel, ZnAl<br>сталь, ZnAl  |
| 128     | 168     | RS-TRIES-128-06   |   |
| 160     | 200     | RS-TRIES-160-06   |   |
| 192     | 232     | RS-TRIES-192-06   |   |
| 256     | 296     | RS-TRIES-256-06   |   |
| 320     | 360     | RS-TRIES-320-06   |   |



Uchwyt UA-326  
Handle UA-326  
Ручка UA-326

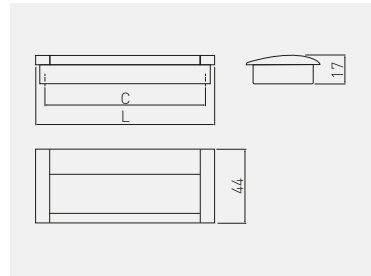

| C<br>mm    | L<br>mm    |  |                                    |                           |                                    |
|------------|------------|--|------------------------------------|---------------------------|------------------------------------|
|            |            | aluminium / chrom<br>aluminium / chrome<br>алюминий / хром | aluminium<br>aluminium<br>алюминий | czarny<br>black<br>чёрный | aluminium<br>aluminium<br>алюминий |
| <b>96</b>  | <b>108</b> | UA-01-326096-V1  | UA-00-326096-05                    | UA-00-326096-20M          |                                    |
| <b>128</b> | <b>140</b> | UA-01-326128-V1  | UA-00-326128-05                    | UA-00-326128-20M          |                                    |
| <b>160</b> | <b>172</b> | UA-01-326160   | UA-00-326160                       | UA-00-326160-20M          |                                    |

Uchwyt UZ-E6  
Handle UZ-E6  
Ручка UZ-E6

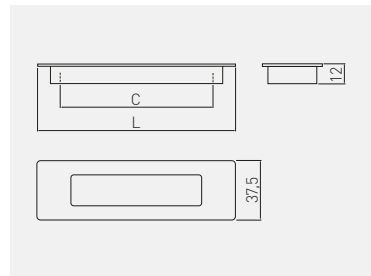

| C<br>mm    | L<br>mm    |                         |                                    |   |      |
|------------|------------|-------------------------|------------------------------------|---|------|
|            |            | chrom<br>chrome<br>хром | aluminium<br>aluminium<br>алюминий | stal szcztokowana<br>brushed steel<br>шлифованная сталь | ZnAl |
| <b>96</b>  | <b>124</b> | UZ-E6-096-01            | UZ-E6-096-05                       | UZ-E6-096-06  |      |
| <b>128</b> | <b>155</b> | UZ-E6-128-01            | UZ-E6-128-05                       | UZ-E6-128-06  |      |
| <b>160</b> | <b>186</b> | UZ-E6-160-01            | UZ-E6-160-05                       | UZ-E6-160-06  |      |

Uchwyt B224  
Handle B224  
Ручка B224

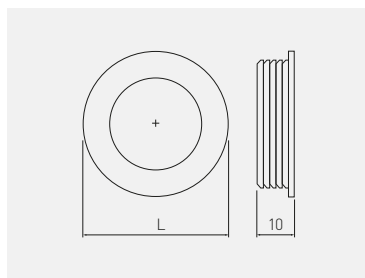

|  L<br>mm |  |  |                                    |                         |                           |      |  |
|---|---|---|------------------------------------|-------------------------|---------------------------|------|--|
|   | chrom<br>chrome<br>хром   | satyna<br>satin<br>сатин  | aluminium<br>aluminium<br>алюминий | biały<br>white<br>белый | czarny<br>black<br>чёрный | ZnAl |  |
| <b>40,5</b>   | UZ-00B224-01  | UZ-00B224-02  | UZ-00B224-05                       | UZ-00B224-10            | UZ-00B224-20              |      |  |

Uchwyt B226  
Handle B226  
Ручка B226

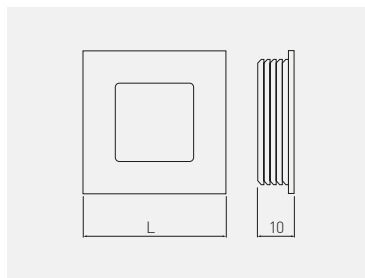
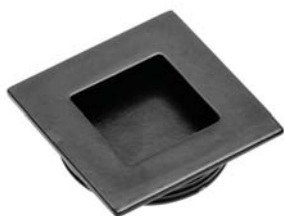

|  L<br>mm |  |  |                                    |                         |                           |      |  |
|---|---|---|------------------------------------|-------------------------|---------------------------|------|--|
|   | chrom<br>chrome<br>хром   | satyna<br>satin<br>сатин  | aluminium<br>aluminium<br>алюминий | biały<br>white<br>белый | czarny<br>black<br>чёрный | ZnAl |  |
| <b>40</b>   | UZ-00B226-01  | UZ-00B226-02  | UZ-00B226-05                       | UZ-00B226-10            | UZ-00B226-20              |      |  |



Uchwyt LIND  
Handle LIND  
Ручка LIND

NEW

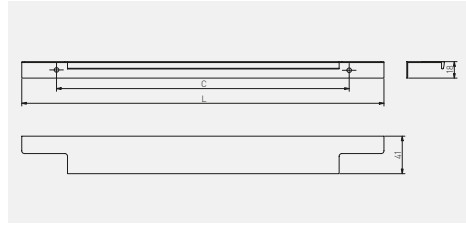

RECESSED

C  
mm

L  
mm



|     |      | chrom<br>chrome<br>хром | aluminium<br>aluminium<br>алюминий | złoty szcztokowany<br>brushed gold<br>матовое золото | czarny matt<br>black matt<br>чёрный матовый |                                    |
|-----|------|-------------------------|------------------------------------|--|---|------------------------------------|
| 256 | 296  | UA-LIND-256-296-01      | UA-LIND-256-296-05                 | UA-LIND-256-296-18                                   | UA-LIND-256-296-20M                         | aluminium<br>aluminium<br>алюминий |
| 320 | 396  | UA-LIND-320-396-01      | UA-LIND-320-396-05                 | UA-LIND-320-396-18                                   | UA-LIND-320-396-20M                         |                                    |
| 224 | 496* | UA-LIND-224-496-01      | UA-LIND-224-496-05                 | UA-LIND-224-496-18                                   | UA-LIND-224-496-20M                         |                                    |
| 256 | 596  | UA-LIND-256-596-01      | UA-LIND-256-596-05                 | UA-LIND-256-596-18                                   | UA-LIND-256-596-20M                         |                                    |
| 352 | 796  | UA-LIND-352-796-01      | UA-LIND-352-796-05                 | UA-LIND-352-796-18                                   | UA-LIND-352-796-20M                         |                                    |

\* Mocowanie na 3 wkręty / Mounted with 3 screws / Крепление на 3 самореза





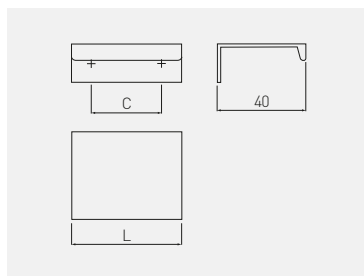

MB

Uchwyt HEXI  
Handle HEXI  
Ручка HEXI

NEW



| <br>C<br>mm | <br>L<br>mm |                         |  |  |  |                                    |
|--|--|-------------------------|---|--|---|------------------------------------|
|  |  | chrom<br>chrome<br>хром | aluminium<br>aluminium<br>алюминий  | biały mat<br>white matt<br>белый матовый | czarny mat<br>black matt<br>чёрный матовый  | aluminium<br>aluminium<br>алюминий |
| <b>32</b>  | <b>50</b>  | UA-HEXI-01              | UA-HEXI-05  | UA-HEXI-10M                              | UA-HEXI-20M   |                                    |
| <b>96</b>  | <b>150</b>   | UA-HEXI96-01            | UA-HEXI96-05  | UA-HEXI96-10M                            | UA-HEXI96-20M   |                                    |
| <b>128</b>   | <b>150</b>   | UA-HEXI-128-01          | UA-HEXI-128-05  | UA-HEXI-128-10M                          | UA-HEXI-128-20M   |                                    |
| <b>160</b>   | <b>190</b>   | UA-HEXI-160-01          | UA-HEXI-160-05  | UA-HEXI-160-10M                          | UA-HEXI-160-20M   |                                    |
| <b>192</b>   | <b>225</b>   | UA-HEXI192-01           | UA-HEXI192-05   | UA-HEXI192-10M                           | UA-HEXI192-20M  |                                    |
| <b>256</b>   | <b>290</b>   | UA-HEXI-256-01          | UA-HEXI-256-05  | UA-HEXI-256-10M                          | UA-HEXI-256-20M   |                                    |
| <b>320</b>   | <b>360</b>   | UA-HEXI-320-01          | UA-HEXI-320-05  | UA-HEXI-320-10M                          | UA-HEXI-320-20M   |                                    |
| <b>do cięcia<br/>to cut<br/>для резки</b>  | <b>3500</b>  | -                       | UA-HEXI-3500-05   | -  | UA-HEXI-3500-20M  |                                    |





| <br>C<br>mm | <br>L<br>mm |                                    |  |  |  |
|---|---|------------------------------------|--|--|--|
|   |   | antracyt<br>anthracite<br>антрацит | złoty szcztokowany<br>brushed gold<br>матовое золото                               |  | aluminium<br>aluminium<br>алюминий   |
| <b>32</b>   | <b>50</b>   | UA-HEXI-60                         | UA-HEXI-18   |  |  |
| <b>96</b>   | <b>150</b>  | UA-HEXI96-60                       | UA-HEXI96-18   |  |  |
| <b>160</b>  | <b>190</b>  | UA-HEXI-160-60                     | UA-HEXI-160-18   |  |  |
| <b>192</b>  | <b>225</b>  | UA-HEXI192-60                      | UA-HEXI192-18  |  |  |
| <b>256</b>  | <b>290</b>  | UA-HEXI-290-60                     | UA-HEXI-290-18   |  |  |
| <b>320</b>  | <b>360</b>  | UA-HEXI-360-60                     | UA-HEXI-360-18   |  |  |



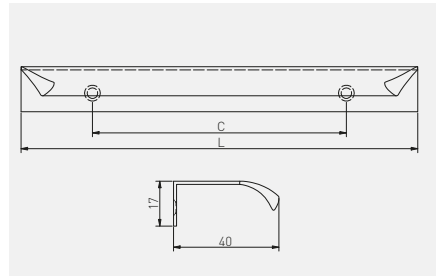



Uchwyt HEXA  
Handle HEXA  
Ручка HEXA

NEW



|  C<br>mm |  L<br>mm |  |  |                         |                                    |
|---|---|---|---|-------------------------|------------------------------------|
|   |   | chrom<br>chrome<br>хром   | aluminium<br>aluminium<br>алюминий  | biały<br>white<br>белый |                                    |
| <b>32</b>   | <b>50</b>   | UA-HEXA-32-01   | UA-HEXA-32-05   | UA-HEXA-32-10M          | aluminium<br>aluminium<br>алюминий |
| <b>96</b>   | <b>150</b>  | UA-HEXA-96-01   | UA-HEXA-96-05   | UA-HEXA-96-10M          |                                    |
| <b>192</b>  | <b>225</b>  | UA-HEXA-192-01  | UA-HEXA-192-05  | UA-HEXA-192-10M         |                                    |
| <b>352</b>  | <b>1200</b>   | -   | UA-HEXA-1200-05   | UA-HEXA-1200-10M        |                                    |

|  C<br>mm |  L<br>mm |  |  |                         |                                    |
|---|---|---|---|-------------------------|------------------------------------|
|   |   | złoty szorstkowany<br>brushed gold<br>матовое золото                                | czarny mat<br>black matt<br>чёрный матовый  | złoty<br>gold<br>золото |                                    |
| <b>32</b>   | <b>50</b>   | UA-HEXA-32-18   | UA-HEXA-32-20M  | -                       | aluminium<br>aluminium<br>алюминий |
| <b>96</b>   | <b>150</b>  | UA-HEXA-96-18   | UA-HEXA-96-20M  | -                       |                                    |
| <b>192</b>  | <b>225</b>  | UA-HEXA-192-18  | UA-HEXA-192-20M   | -                       |                                    |
| <b>352</b>  | <b>1200</b>   | -   | UA-HEXA-1200-20M  | UA-HEXA-1200-22         |                                    |





Uchwyt PICADO  
Handle PICADO  
Ручка PICADO

NEW

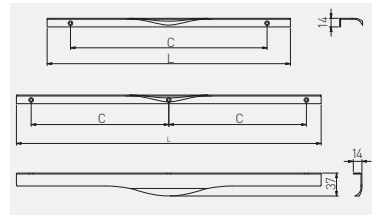

C  
mm

L  
mm



| C        | L   | chrom<br>chrome<br>хром | aluminium<br>aluminum<br>алюминий | aluminium<br>aluminium<br>алюминий |
|----------|-----|-------------------------|-----------------------------------|------------------------------------|
| 256      | 296 | UA-PICADO-256-296-01    | UA-PICADO-256-296-05              |                                    |
| 320      | 396 | UA-PICADO-320-396-01    | UA-PICADO-320-396-05              |                                    |
| 2 x 224* | 496 | UA-PICADO-224-496-01    | UA-PICADO-224-496-05              |                                    |
| 2 x 256* | 596 | UA-PICADO-256-596-01    | UA-PICADO-256-596-05              |                                    |
| 2 x 352* | 796 | UA-PICADO-352-796-01    | UA-PICADO-352-796-05              |                                    |

C  
mm

L  
mm



| C        | L   | złoty szczotkowany<br>brushed gold<br>матовое золото | czarny mat<br>black matt<br>чёрный матовый | aluminium<br>aluminium<br>алюминий |
|----------|-----|--|--|------------------------------------|
| 256      | 296 | UA-PICADO-256-296-18                                 | UA-PICADO-256-296-20M                      |                                    |
| 320      | 396 | UA-PICADO-320-396-18                                 | UA-PICADO-320-396-20M                      |                                    |
| 2 x 224* | 496 | UA-PICADO-224-496-18                                 | UA-PICADO-224-496-20M                      |                                    |
| 2 x 256* | 596 | UA-PICADO-256-596-18                                 | UA-PICADO-256-596-20M                      |                                    |
| 2 x 352* | 796 | UA-PICADO-352-796-18                                 | UA-PICADO-352-796-20M                      |                                    |

\* Mocowanie na 3 wkręty / Mounted with 3 screws / Крепление на 3 самореза



Uchwyt FIORD  
Handle FIORD  
Ручка FIORD

NEW

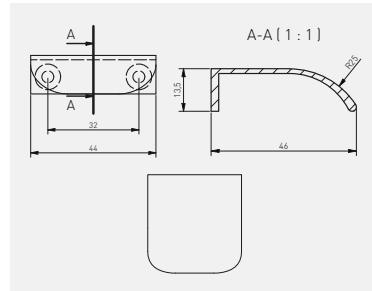

EDGE MOUNTED

|   | aluminium<br>aluminium<br>алюминий | stal szorstkowana<br>brushed steel<br>шлифованная сталь | złoto szorstkowane<br>brushed gold<br>матовое золото | czarny mat<br>black matt<br>чёрный матовый |      |
|---|------------------------------------|---|--|--|------|
| <b>gatka</b><br><b>knob</b><br><b>ручка</b> | UZ-FIORD-32-05                     | UZ-FIORD-32-06  | UZ-FIORD-32-18                                       | UZ-FIORD-32-20M                            | ZnAl |

Uchwyt TREX  
Handle TREX  
Ручка TREX

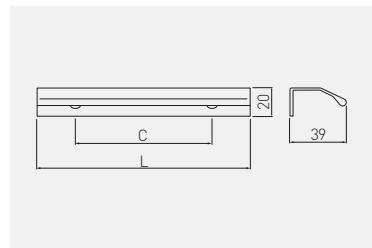

| <b>C</b><br>mm  | <b>L</b><br>mm | aluminium<br>aluminium<br>алюминий | czarny mat<br>black matt<br>чёрный матовый |                                    |
|---|----------------|------------------------------------|--|------------------------------------|
| 32  | 50             | UA-TREX-32-50-05                   | UA-TREX-32-50-20M                          | aluminium<br>aluminium<br>алюминий |
| 96  | 150            | UA-TREX-96-150-05                  | UA-TREX-96-150-20M                         |                                    |
| 224   | 250            | UA-TREX-224-250-05                 | UA-TREX-224-250-20M                        |                                    |
| 320   | 350            | UA-TREX-320-350-05                 | UA-TREX-320-350-20M                        |                                    |
| <b>do cięcia</b><br><b>to cut</b><br><b>для резки</b> | 3500           | UA-TREX-3500-05                    | UA-TREX-3500-20M                           |                                    |

Uchwyt PROFIL C  
Handle PROFIL C  
Ручка PROFIL C

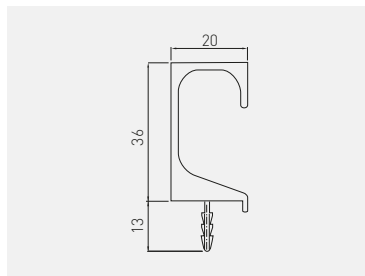

| C<br>mm                                   | L<br>mm     |                                    |   |  |                                    |
|---|-------------|------------------------------------|---|--|------------------------------------|
|   |             | aluminium<br>aluminium<br>алюминий | stal szczotkowana<br>brushed steel<br>шлифованная сталь | czarny mat<br>black matt<br>чёрный матовый | aluminium<br>aluminium<br>алюминий |
| <b>do cięcia<br/>to cut<br/>для резки</b> | <b>3500</b> | PA-0242-35-50                      | PA-0242-35-50-06  | PA-0242-35-50-20M                          |                                    |

Uchwyt PROFIL C2  
Handle PROFIL C2  
Ручка PROFIL C2

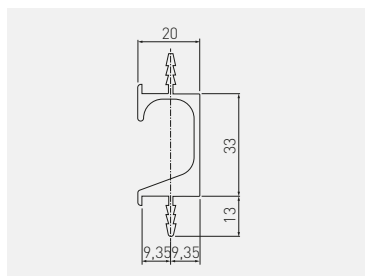

| C<br>mm                                   | L<br>mm     |                                    |                                    |
|---|-------------|------------------------------------|------------------------------------|
|   |             | aluminium<br>aluminium<br>алюминий | aluminium<br>aluminium<br>алюминий |
| <b>do cięcia<br/>to cut<br/>для резки</b> | <b>3500</b> | PA-0241-35-50                      |                                    |



Uchwyt PROFIL L  
Handle PROFIL L  
Ручка PROFIL L

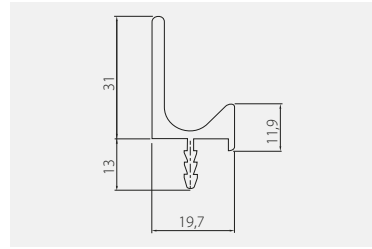

| <br>C<br>mm | <br>L<br>mm |  |  |  |                                    |
|--|--|---|---|--|------------------------------------|
|  |  | aluminium<br>aluminium<br>алюминий  | stal szcztokowana<br>brushed steel<br>шлифованная сталь                           | czarny mat<br>black matt<br>чёрный матовый | aluminium<br>aluminium<br>алюминий |
| <b>do cięcia<br/>to cut<br/>для резки</b>  | <b>3500</b>  | PA-0243-35-50   | PA-0243-35-50-06  | PA-0243-35-50-20M                          |                                    |

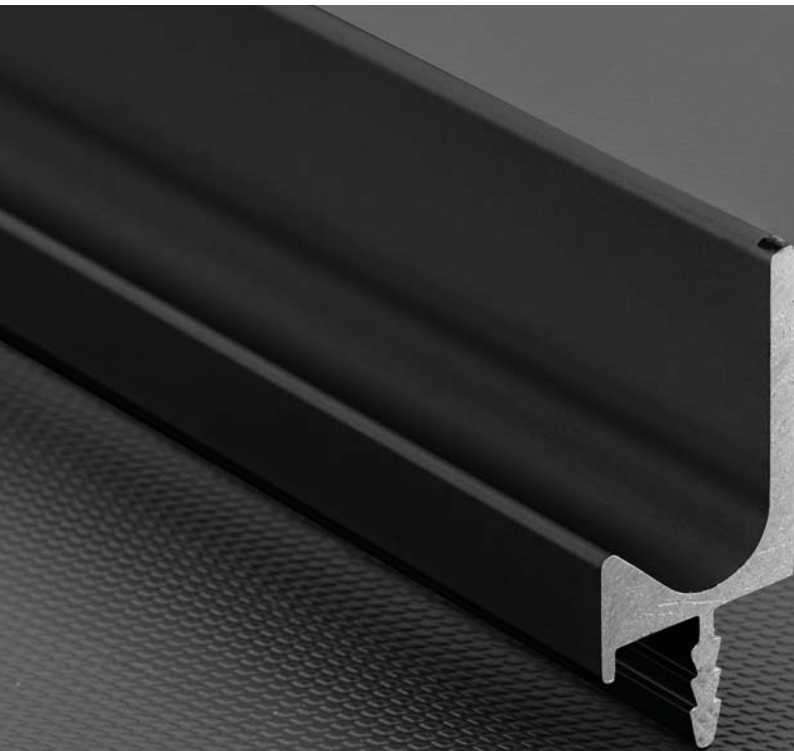

System bezuchwytowy VELLO  
VELLO handleless system  
Система профилей VELLO

NEW

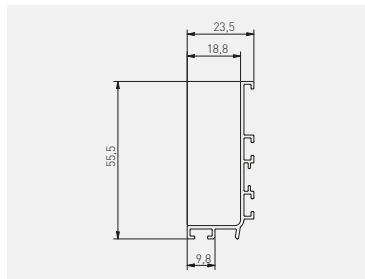

|                                  | C<br>mm | L<br>mm |                                    |   |                         |
|----------------------------------|---------|---------|------------------------------------|---|-------------------------|
|                                  |         |         | aluminium<br>aluminium<br>алюминий | stal szcztokowana<br>brushed steel<br>шлифованная сталь | biały<br>white<br>белый |
| do cięcia<br>to cut<br>для резки | 3000    |         | PA-VELLO-L3M-05                    | PA-VELLO-L3M-06   | PA-VELLO-L3M-10         |
|                                  | 4100    |         | PA-VELLO-L4M-05                    | PA-VELLO-L4M-06   | PA-VELLO-L4M-10         |
|                                  |         |         | aluminium<br>aluminium<br>алюминий |   |                         |

|                                  | C<br>mm | L<br>mm |  |                         |                                    |
|----------------------------------|---------|---------|--|-------------------------|------------------------------------|
|                                  |         |         | czarny mat<br>black matt<br>чёрный матовый | złoty<br>gold<br>золото | aluminium<br>aluminium<br>алюминий |
| do cięcia<br>to cut<br>для резки | 3000    |         | PA-VELLO-L3M-20M                           | -                       |                                    |
|                                  | 4100    |         | PA-VELLO-L4M-20M                           | PA-VELLO-L4M-21         |                                    |

Aksesoria / Accessories / Аксессуары



PA-ZASVELLO-LNL-20M



PA-ZASVELLO-LNP-20M



PA-ZASVELLO-LPL-20M



PA-ZASVELLO-LPP-20M



Ostonki / Covers / Крышки

PA-OSMLGLAXMIC3M-00N

| aluminium<br>aluminium<br>алюминий | stal szcztokowana<br>brushed steel<br>шлифованная сталь | biały<br>white<br>белый | tworzywo<br>plastic<br>пластмасса |
|------------------------------------|---|-------------------------|-----------------------------------|
| PA-ZASVELLO-LNL-05                 | PA-ZASVELLO-LNL-06                                      | PA-ZASVELLO-LNL-10      |                                   |
| PA-ZASVELLO-LNP-05                 | PA-ZASVELLO-LNP-06                                      | PA-ZASVELLO-LNP-10      |                                   |
| PA-ZASVELLO-LPL-05                 | PA-ZASVELLO-LPL-06                                      | PA-ZASVELLO-LPL-10      |                                   |
| PA-ZASVELLO-LPP-05                 | PA-ZASVELLO-LPP-06                                      | PA-ZASVELLO-LPP-10      |                                   |

| czarny mat<br>black matt<br>чёрный матовый | złoty<br>gold<br>золото | tworzywo<br>plastic<br>пластмасса |
|--|-------------------------|-----------------------------------|
| PA-ZASVELLO-LNL-20M                        | PA-ZASVELLO-LNL-21      |                                   |
| PA-ZASVELLO-LNP-20M                        | PA-ZASVELLO-LNP-21      |                                   |
| PA-ZASVELLO-LPL-20M                        | PA-ZASVELLO-LPL-21      |                                   |
| PA-ZASVELLO-LPP-20M                        | PA-ZASVELLO-LPP-21      |                                   |



PA-MOUNT-GL-00

Możliwość zastosowania oświetlenia LED. Polecana ostonka PA-OSMLGLAXMIC3M-00N  
Possibility of using LED lighting. Recommended PA-OSMLGLAXMIC3M-00N cover.  
Возможность использования светодиодного освещения. Рекомендуемая заглушка PA-OSMLGLAXMIC3M-00N



System bezuchwytowy VELLO  
VELLO handleless system  
Система профилей VELLO

NEW

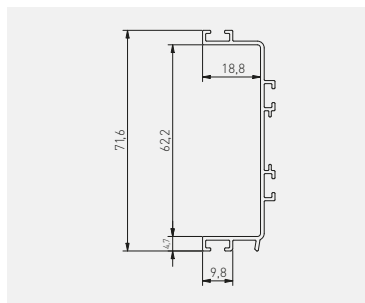

|   | C<br>mm     | L<br>mm         |   |                         |                                    |
|---|-------------|-----------------|---|-------------------------|------------------------------------|
|   |             |                 | stal szorstkowana<br>brushed steel<br>шлифованная сталь | biały<br>white<br>белый | aluminium<br>aluminium<br>алюминий |
| <b>do cięcia<br/>to cut<br/>для резки</b> | <b>3000</b> | PA-VELLO-C3M-05 | PA-VELLO-C3M-06   | PA-VELLO-C3M-10         |                                    |
|   | <b>4100</b> | PA-VELLO-C4M-05 | PA-VELLO-C4M-06   | PA-VELLO-C4M-10         |                                    |

|   | C<br>mm     | L<br>mm          |  |                         |                                    |
|---|-------------|------------------|--|-------------------------|------------------------------------|
|   |             |                  | czarny mat<br>black matt<br>чёрный матовый | złoty<br>gold<br>золото | aluminium<br>aluminium<br>алюминий |
| <b>do cięcia<br/>to cut<br/>для резки</b> | <b>3000</b> | PA-VELLO-C3M-20M | -  |                         |                                    |
|   | <b>4100</b> | PA-VELLO-C4M-20M | PA-VELLO-C4M-21                            |                         |                                    |

Aksesoria / Accessories / Аксессуары



PA-ZASVELLO-CN-20M



PA-ZASVELO-CP-20M



PA-MOUNT-GL-00

Ostonki / Covers / Крышки



PA-OSMLGLAXMIC3M-00N

|                   | aluminium<br>aluminium<br>алюминий | stal szorstkowana<br>brushed steel<br>шлифованная сталь | biały<br>white<br>белый | tworzywo<br>plastic<br>пластмасса |
|-------------------|------------------------------------|---|-------------------------|-----------------------------------|
| PA-ZASVELLO-CN-05 | PA-ZASVELLO-CN-06                  | PA-ZASVELLO-CN-10                                       |                         |                                   |
| PA-ZASVELLO-CP-05 | PA-ZASVELLO-CP-06                  | PA-ZASVELO-CP-10  |                         |                                   |

|                    | czarny mat<br>black matt<br>чёрный матовый | złoty<br>gold<br>золото | tworzywo<br>plastic<br>пластмасса |
|--------------------|--|-------------------------|-----------------------------------|
| PA-ZASVELLO-CN-20M | PA-ZASVELLO-CN-21                          |                         |                                   |
| PA-ZASVELO-CP-20M  | PA-ZASVELLO-CP-21                          |                         |                                   |

Możliwość zastosowania oświetlenia LED. Polecana ostonka PA-OSMLGLAXMIC3M-00N

Possibility of using LED lighting. Recommended PA-OSMLGLAXMIC3M-00N cover.

Возможность использования светодиодного освещения. Рекомендуемая заглушка PA-OSMLGLAXMIC3M-00N



System bezuchwytowy VELLO  
 VELLO handleless system  
 Система профилей VELLO

NEW

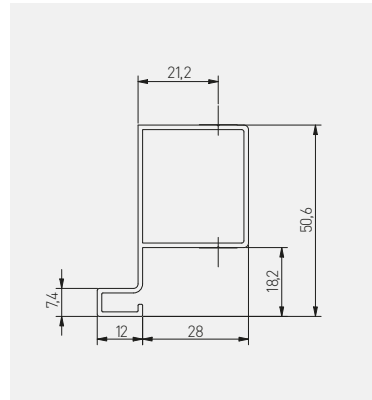

|   |  C<br>mm |  L<br>mm |  |  |  |                                    |
|---|---|---|---|---|---|------------------------------------|
|   |   |   | aluminium<br>aluminium<br>алюминий  | stal szorstkowana<br>brushed steel<br>шлифованная сталь                             | biały<br>white<br>белый   | aluminium<br>aluminium<br>алюминий |
| <b>do cięcia<br/>to cut<br/>для резки</b> | <b>3000</b>   | PA-VELLO-TJ3M-05  | PA-VELLO-TJ3M-06  | PA-VELLO-TJ3M-10  |   |                                    |

|   |  C<br>mm |  L<br>mm |  |  |  |
|---|---|---|---|---|---|
|   |   |   | czarny mat<br>black matt<br>чёрный матовый  | złoty<br>gold<br>золото   | aluminium<br>aluminium<br>алюминий  |
| <b>do cięcia<br/>to cut<br/>для резки</b> | <b>3000</b>   | PA-VELLO-TJ3M-20M   | PA-VELLO-TJ3M-21  |   |   |

System bezuchwytowy VELLO  
 VELLO handleless system  
 Система профилей VELLO

NEW

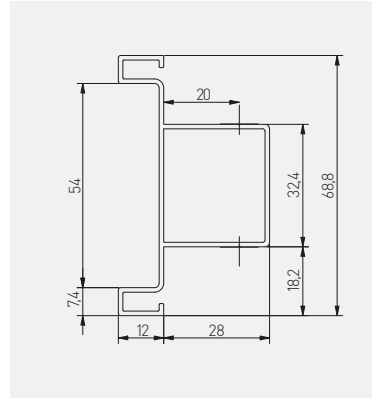



|  C<br>mm |  L<br>mm |  |  |                         |   |
|---|---|---|---|-------------------------|---|
|   |   | aluminium<br>aluminium<br>алюминий  | stal szorstkowana<br>brushed steel<br>шлифованная сталь                             | biały<br>white<br>белый |  |
| <b>do cięcia<br/>to cut<br/>для резки</b>   | 3000  | PA-VELLO-TD3M-05  | PA-VELLO-TD3M-06  | PA-VELLO-TD3M-10        | aluminium<br>aluminium<br>алюминий  |

|  C<br>mm |  L<br>mm |  |  |   |
|---|---|---|---|---|
|   |   | czarny mat<br>black matt<br>чёрный матовый  | złoty<br>gold<br>золото   |  |
| <b>do cięcia<br/>to cut<br/>для резки</b>   | 3000  | PA-VELLO-TD3M-20M   | PA-VELLO-TD3M-21  | aluminium<br>aluminium<br>алюминий  |

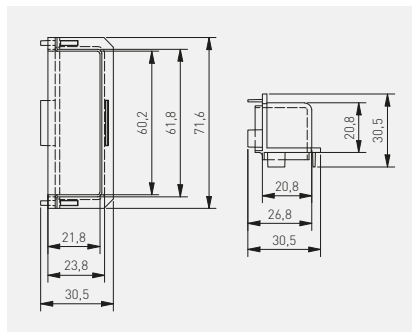

System bezuchwytowy VELLO  
VELLO handleless system  
Система профилей VELLO

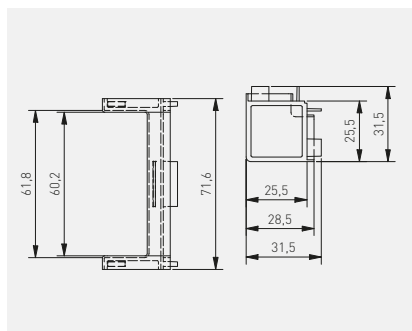

|   |                                   |   |                                   |
|---|-----------------------------------|---|-----------------------------------|
|  |                                   |  |                                   |
| aluminium<br>aluminium<br>алюминий  | inox<br>inox<br>шлифованная сталь | biały<br>white<br>белый   | tworzywo<br>plastic<br>пластмасса |
| PA-LACZVELLO-CIN-05   | PA-LACZVELLO-CIN-06               | PA-LACZVELLO-CIN-10M  |                                   |
|  |                                   |  |                                   |
| czarny mat<br>black matt<br>чёрный матовый  | złoty<br>gold<br>золото           | tworzywo<br>plastic<br>пластмасса   |                                   |
| PA-LACZVELLO-CIN-20M  | PA-LACZVELLO-CIN-21               |   |                                   |

System bezuchwytowy VELLO  
VELLO handleless system  
Система профилей VELLO



|   |                                   |   |                                   |
|---|-----------------------------------|---|-----------------------------------|
|  |                                   |  |                                   |
| aluminium<br>aluminium<br>алюминий  | inox<br>inox<br>шлифованная сталь | biały<br>white<br>белый   | tworzywo<br>plastic<br>пластмасса |
| PA-LACZVELLO-COUT-05  | PA-LACZVELLO-COUT-06              | PA-LACZVELLO-COUT-10M   |                                   |
|  |                                   |  |                                   |
| czarny mat<br>black matt<br>чёрный матовый  | złoty<br>gold<br>золото           | tworzywo<br>plastic<br>пластмасса   |                                   |
| PA-LACZVELLO-COUT-20M   | PA-LACZVELLO-COUT-21              |   |                                   |



System bezuchwytowy VELLO  
VELLO handleless system  
Система профилей VELLO

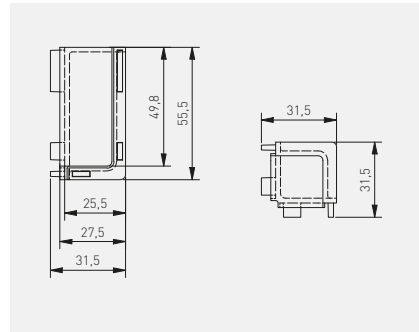

|   |                                   |   |                                   |
|---|-----------------------------------|---|-----------------------------------|
|  |                                   |  |                                   |
| aluminium<br>aluminium<br>алюминий  | inox<br>inox<br>шлифованная сталь | biały<br>white<br>белый   | tworzywo<br>plastic<br>пластмасса |
| PA-LACZVELLO-LIN-05   | PA-LACZVELLO-LIN-06               | PA-LACZVELLO-LIN-10M  |                                   |
|  |                                   |  |                                   |
| czarny mat<br>black matt<br>чёрный матовый  | złoty<br>gold<br>золото           | tworzywo<br>plastic<br>пластмасса   |                                   |
| PA-LACZVELLO-LIN-20M  | PA-LACZVELLO-LIN-21               |   |                                   |

System bezuchwytowy VELLO  
VELLO handleless system  
Система профилей VELLO

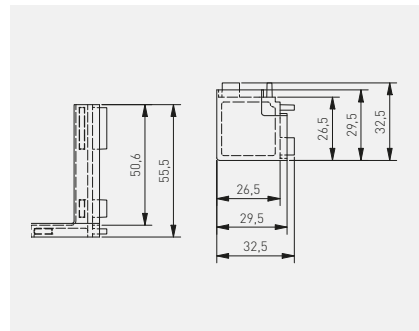

|   |                                   |   |                                   |
|---|-----------------------------------|---|-----------------------------------|
|  |                                   |  |                                   |
| aluminium<br>aluminium<br>алюминий  | inox<br>inox<br>шлифованная сталь | biały<br>white<br>белый   | tworzywo<br>plastic<br>пластмасса |
| PA-LACZVELLO-LOUT-05  | PA-LACZVELLO-LOUT-06              | PA-LACZVELLO-LOUT-10M   |                                   |
|  |                                   |  |                                   |
| czarny mat<br>black matt<br>чёрный матовый  | złoty<br>gold<br>золото           | tworzywo<br>plastic<br>пластмасса   |                                   |
| PA-LACZVELLO-LOUT-20M   | PA-LACZVELLO-LOUT-21              |   |                                   |

Gatka J4  
Knob J4  
Ручка J4

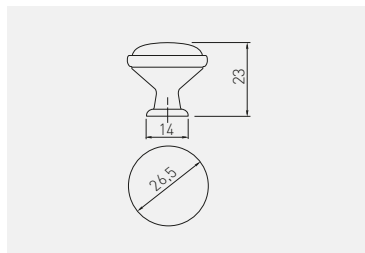

| motyw<br>pattern<br>рисунок | antyczny mosiądz<br>antique brass<br>античная латунь | antyczne srebro<br>antique silver<br>старинное серебро |  |
|-----------------------------|--|--|--|
| autumn rose                 | GP-0728-J4-B   | -  | ZnAl, porcelana<br>ZnAl, porcelain<br>ZnAl, фарфор |
| spring flower               | GP-0728-J4-R   | -  |  |
| blue rose                   | GP-0728-J4-A-04                                      | GP-0728-J4-A-07  |  |
| orient gold                 | GP-0728-J4-C-04                                      | -  |  |



autumn rose

spring flower

blue rose

orient gold

Uchwyt 728B  
Handle 728B  
Ручка 728B

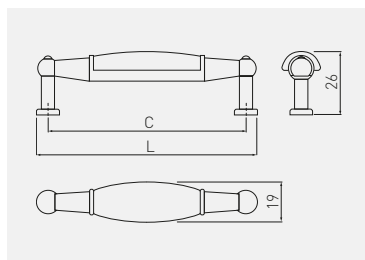

| motyw<br>pattern<br>рисунок | C<br>mm | L<br>mm | antyczny mosiądz<br>antique brass<br>античная латунь |  |
|-----------------------------|---------|---------|--|--|
| spring flower               | 96      | 106     | UP-WP0728-BR   | ZnAl, porcelana<br>ZnAl, porcelain<br>ZnAl, фарфор |
| country                     | 96      | 106     | UP-WP0728-BK   |  |
| ornament                    | 96      | 106     | UP-WP0728-BX   |  |
| autumn rose                 | 96      | 106     | UP-WP0728-BB   |  |



spring flower

country

ornament

autumn rose

Uchwyt 728P  
Handle 728P  
Ручка 728P

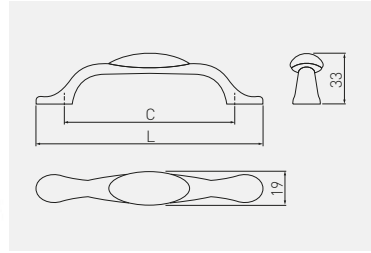

| motyw<br>pattern<br>рисунок | C<br>mm | L<br>mm | antyczny mosiądz<br>antique brass<br>античная латунь | antyczne srebro<br>antique silver<br>старинное серебро | ZnAl, porcelana<br>ZnAl, porcelain<br>ZnAl, фарфор |
|-----------------------------|---------|---------|--|--|--|
| blue rose                   | 96      | 125     | UP-WP0728-PA-04                                      | UP-WP0728-PA-07  |  |
| orient gold                 | 96      | 125     | UP-WP0728-PC-04                                      | -  |  |
| ornament                    | 96      | 125     | UP-WP0728-PX   | -  |  |
| autumn rose                 | 96      | 125     | UP-WP0728-PB   | -  |  |
| spring flower               | 96      | 125     | UP-WP0728-PR   | -  |  |
| country                     | 96      | 125     | UP-WP0728-PK   | -  |  |
| milky                       | 96      | 125     | UP-WP0728-P0   | -  |  |



blue rose



orient gold



ornament



autumn rose



spring flower



country



milky

Uchwyt ALATRI  
Handle ALATRI  
Ручка ALATRI

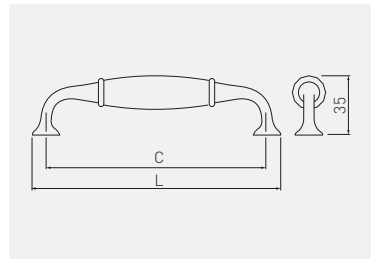

| C<br>mm | L<br>mm | antyczny mosiądz<br>antique brass<br>античная латунь | ZnAl, porcelana<br>ZnAl, porcelain<br>ZnAl, фарфор |
|---------|---------|--|--|
| 128     | 144     | UZ-ALATR-128-04                                      |  |



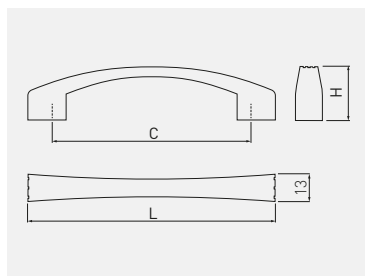



Uchwyt VASTO  
Handle VASTO  
Ручка VASTO

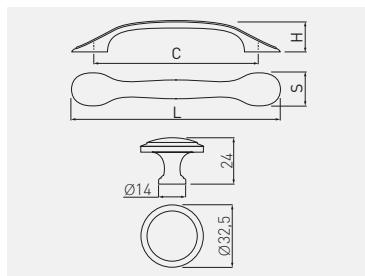

|  C<br>mm |  L<br>mm |  H<br>mm |    |  |
|---|---|---|---|---|
|   |   |   | antyczny miedź szczotkowany<br>antique brushed brass<br>античная шлифованная латунь | ZnAl  |
| 96  | 120   | 26  | UZ-VASTO-96-09  |   |
| 128   | 151   | 27  | UZ-VASTO-128-09   |   |

Uchwyt PALERMO  
Handle PALERMO  
Ручка PALERMO



|  C<br>mm |  L<br>mm |  H<br>mm |  S<br>mm |  |  |
|---|---|---|---|---|---|
|   |   |   |   | antyczne srebro<br>antique silver<br>античное серебро                               | ZnAl  |
| 96  | 127   | 22,5  | 23  | UZ-PALER-96-07  |   |
| 128   | 159   | 23  | 25  | UZ-PALER-128-07   |   |
| galka<br>knob<br>ручка  | -   | -   | -   | GZ-PALER-1-07   |   |

Uchwyt UZ-10  
Handle UZ-10  
Ручка UZ-10

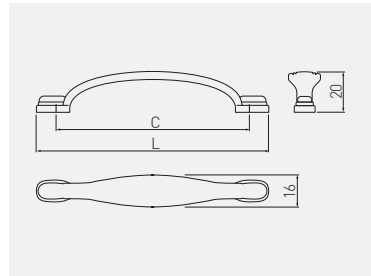

| C<br>mm | L<br>mm |  |  |
|---------|---------|---|---|
| 96      | 120     | antyczny mosiądz<br>antique brass<br>античная латунь                              | ZnAl  |
|         |         | UZ-10-096-N04   |   |

Uchwyt UZ-12  
Handle UZ-12  
Ручка UZ-12

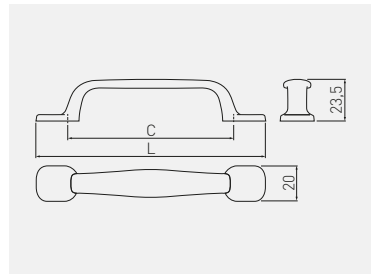

| C<br>mm | L<br>mm |  |  |  |  |
|---------|---------|---|---|---|---|
| 96      | 131     | antyczny mosiądz<br>antique brass<br>античная латунь                                | antyczne srebro<br>antique silver<br>античное серебро                               | czarny mat<br>black matt<br>чёрный матовый  | ZnAl  |
|         |         | UZ-12-096-04N   | UZ-12-096-07  | UZ-12-096-20M   |   |

Uchwyt RETRIS  
Handle RETRIS  
Ручка RETRIS

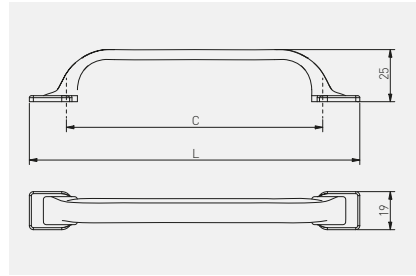

| C<br>mm | L<br>mm |  |   |  |      |
|---------|---------|--|---|--|------|
|         |         | antyczny mosiądz<br>antique brass<br>античная латунь | antyczne srebro<br>antique silver<br>античное серебро | czarny mat<br>black matt<br>чёрный матовый | ZnAl |
| 128     | 165     | UZ-RETRIS-128-04                                     | UZ-RETRIS-128-07                                      | UZ-RETRIS-128-20M                          |      |



Gatka ARDEA  
Knob ARDEA  
Ручка ARDEA

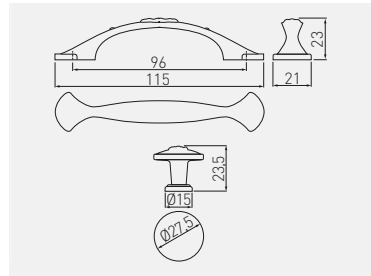

|  C<br>mm |  L<br>mm |  |  |
|---|---|---|---|
|   |   | antyczny mosiądz<br>antique brass<br>античная латунь                              | ZnAl  |
| <b>96</b>   | <b>115</b>  | UZ-ARDEA-96-09  |   |
| <b>gatka<br/>knob<br/>ручка</b>   | -   | GZ-ARDEA-1-09   |   |

Uchwyt WERONA  
Handle WERONA  
Ручка WERONA

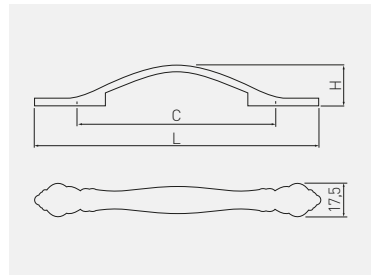

|  C<br>mm |  L<br>mm |  H<br>mm |  |    |  |  |
|---|---|---|---|---|---|---|
|   |   |   | antyczny mosiądz<br>antique brass<br>античная латунь                                | antyczny mosiądz szcztokowany<br>antique brushed brass<br>античная шлифованная латунь | czarny chrom<br>black chrome<br>чёрный хром   | ZnAl  |
| <b>96</b>   | <b>148</b>  | <b>24,5</b>   | UZ-WERON-96-04  | UZ-WERON-96-09  | UZ-WERON-96-12  |   |
| <b>128</b>  | <b>183</b>  | <b>26,5</b>   | UZ-WERON-128-04   | UZ-WERON-128-09   | UZ-WERON-128-12   |   |

Uchwyt ARCHE\*  
Handle ARCHE\*  
Ручка ARCHE\*

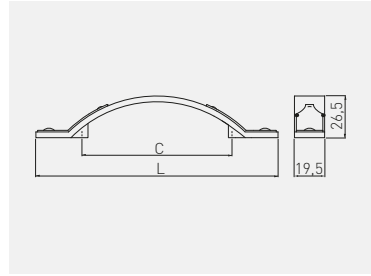

| C<br>mm | L<br>mm |      |  |
|---------|---------|---|---|
| 96      | 155     | antyczny mosiądz szczotkowany<br>antique brushed brass<br>античная шлифованная латунь | ZnAl  |
|         |         | UZ-ARCH096-AEB  |   |

\* Produkt dostępny na indywidualne zamówienie / Available for special orders / Товар доступен под заказ

Uchwyt AREZO  
Handle AREZO  
Ручка AREZO

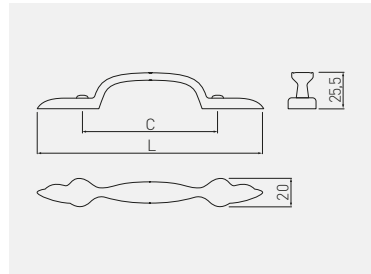

| C<br>mm | L<br>mm |  |  |
|---------|---------|---|---|
| 96      | 160     | antyczny mosiądz<br>antique brass<br>античная латунь                                | ZnAl  |
|         |         | UZ-AREZO-96-04  |   |



Uchwyt ABIATE  
Handle ABIATE  
Ручка ABIATE

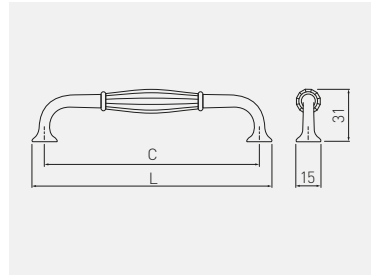

| C<br>mm | L<br>mm |  |  |
|---------|---------|---|---|
|         |         | antyczny mosiądz<br>antique brass<br>античная латунь                              | ZnAl  |
| 128     | 143     | UZ-ABIAT-128-04   |   |

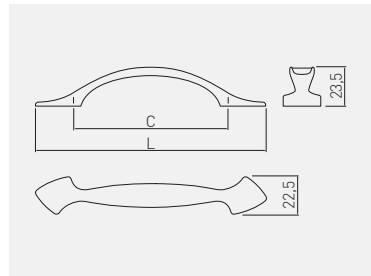

Uchwyt ADRIN  
Handle ADRIN  
Ручка ADRIN



| C<br>mm | L<br>mm |  |  |
|---------|---------|---|---|
|         |         | antyczny mosiądz<br>antique brass<br>античная латунь                                | ZnAl  |
| 96      | 139     | UZ-ADRIN-96-04  |   |

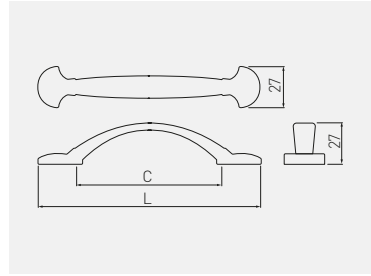



Uchwyt ACERA  
Handle ACERA  
Ручка ACERA

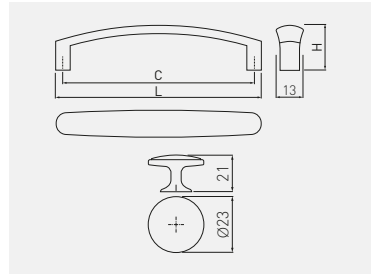

|  C<br>mm |  L<br>mm |  |  |
|---|---|---|---|
|   |   | antyczny mosiądz<br>antique brass<br>античная латунь                              | ZnAl  |
| <b>96</b>   | <b>147</b>  | UZ-ACERA-96-04  |   |

Uchwyt OLBIA  
Handle OLBIA  
Ручка OLBIA



|  C<br>mm |  L<br>mm |  H<br>mm |  |  |
|---|---|---|---|---|
|   |   |   | antyczny mosiądz<br>antique brass<br>античная латунь                                | ZnAl  |
| <b>96</b>   | <b>103</b>  | <b>22</b>   | UZ-OLBIA-96-04  |   |
| <b>128</b>  | <b>136</b>  | <b>24</b>   | UZ-OLBIA-128-04   |   |
| <b>gatka<br/>knob<br/>ручка</b>   | -   | -   | GZ-OLBIA-1-04   |   |

Uchwyt MARSALA  
Handle MARSALA  
Ручка MARSALA

NEW

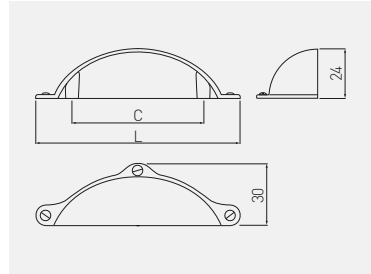

| C<br>mm | L<br>mm |   |   |  |  |      |
|---------|---------|---|---|--|--|------|
|         |         | antyczne srebro<br>antique silver<br>античное серебро       | antyczny mosiądz szcztokowany<br>antique brushed brass<br>античная шлифованная латунь | biały mat<br>white matt<br>белый матовый             | ZnAl                                       |      |
| 64      | 99,5    | UZ-MARSA-64-07  | UZ-MARSA-64-09  | UZ-MARSA-64-10M                                      |  |      |
| C<br>mm | L<br>mm |   |   |  |  |      |
|         |         | tytan szcztokowany<br>brushed titanium<br>шлифованный титан | miedź<br>copper<br>медь   | złoty szcztokowany<br>brushed gold<br>матовое золото | czarny mat<br>black matt<br>чёрный матовый | ZnAl |
| 64      | 99,5    | UZ-MARSA-64-11  | UZ-MARSA-64-15  | UZ-MARSA-64-18                                       | UZ-MARSA-64-20M                            |      |



Uchwyt ROYAL  
Handle ROYAL  
Ручка ROYAL

RETRO

GZ-ROYAL3-1-10-03



UZ-ROYAL4-96-03



UZ-ROYAL1-96-10-03



UZ-ROYAL2-96-10-03







UZ-ROYAL3-96-10-03

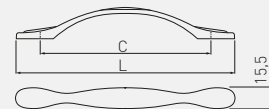
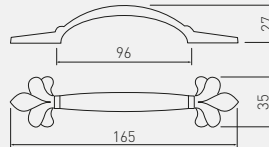
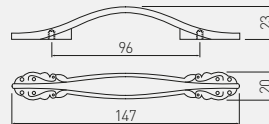
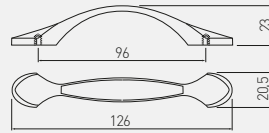
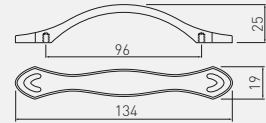
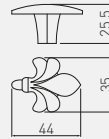

UZ-ROYAL5-128-10-03



|  |  C<br>mm |  L<br>mm |  |  |
|---|---|---|---|---|
| <b>motyw</b><br><b>pattern</b><br><b>рисунок</b>                                    |   |   | biały, złoty<br>white, gold<br>белый, золото  |   |
| <b>latina</b>   | <b>96</b>   | <b>126</b>  | UZ-ROYAL1-96-10-03  | ZnAl  |
| <b>werona</b>   | <b>96</b>   | <b>147</b>  | UZ-ROYAL2-96-10-03  |   |
| <b>genova</b>   | <b>96</b>   | <b>165</b>  | UZ-ROYAL3-96-10-03  |   |
| <b>reggio</b>   | <b>96</b>   | <b>134</b>  | UZ-ROYAL4-96-03   |   |
| <b>piano</b>  | <b>96</b>   | <b>131</b>  | UZ-ROYAL5-96-10-03  |   |
|   | <b>128</b>  | <b>164</b>  | UZ-ROYAL5-128-10-03   |   |
| <b>genova</b>   | <b>gatka</b><br><b>knob</b><br><b>ручка</b>   | <b>35</b>   | GZ-ROYAL3-1-10-03   |   |

Gatka UZ-WP146  
 Knob UZ-WP146  
 Ручка UZ-WP146

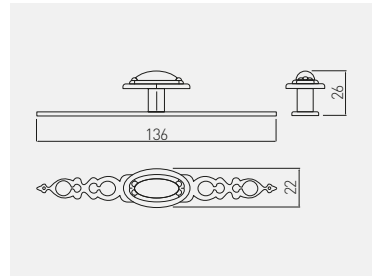

|                        |   |   |
|------------------------|---|---|
|                        |  |  |
|                        | antyczny mosiądz<br>antique brass<br>античная латунь                              | ZnAl  |
| gatka<br>knob<br>ручка | UZ-WP1146-04  |   |

Gatka GZ-1136  
 Knob GZ-1136  
 Ручка GZ-1136

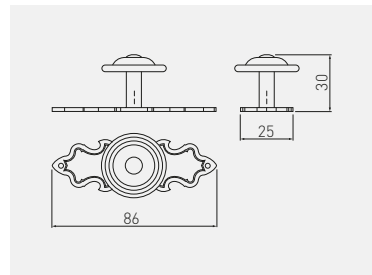

|                        |   |   |
|------------------------|---|---|
|                        |  |  |
|                        | antyczny mosiądz<br>antique brass<br>античная латунь                                | ZnAl  |
| gatka<br>knob<br>ручка | GZ-WP1136-04  |   |

Gatka GZ-1148  
 Knob GZ-1148  
 Ручка GZ-1148

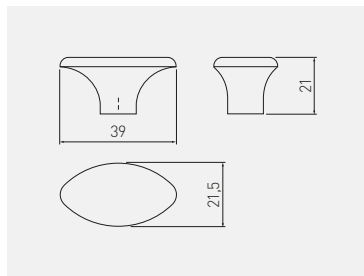

|   |   |   |
|---|---|---|
|   |  |  |
|   | antyczny mosiądz<br>antique brass<br>античная латунь                              | ZnAl  |
| <b>gatka</b><br><b>knob</b><br><b>ручка</b> | GZ-WP1148-04  |   |

Gatka GZ-1152\*  
 Knob GZ-1152\*  
 Ручка GZ-1152\*

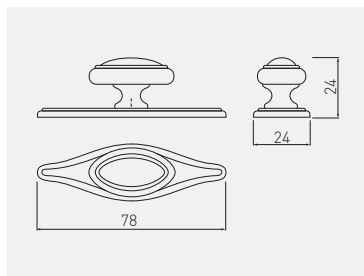

|   |   |   |
|---|---|---|
|   |  |  |
|   | antyczny mosiądz<br>antique brass<br>античная латунь                                | ZnAl  |
| <b>gatka</b><br><b>knob</b><br><b>ручка</b> | GZ-WP1152-04  |   |

\* Produkt dostępny na indywidualne zamówienie / Available for special orders / Товар доступен под заказ

Uchwyt RENNES  
Handle RENNES  
Ручка RENNES

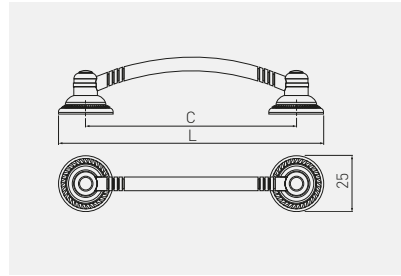

|  |  |   |   |
|--|--|---|---|
| <br>C<br>mm | <br>L<br>mm |  |  |
| 96   | 121  | antyczny mosiądz<br>antique brass<br>античная латунь                              | ZnAl  |
| UZ-REN096-04A  |  |   |   |

Kołatka KT-1147  
Knocker KT-1147  
Ручка KT-1147

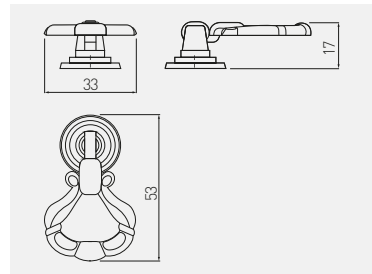

|                             |   |   |
|-----------------------------|---|---|
|                             |  |  |
| kołatka<br>knocker<br>ручка | antyczny mosiądz<br>antique brass<br>античная латунь                                | ZnAl  |
| KT-WP1147-04                |   |   |

Gatka CENTO  
Knob CENTO  
Ручка CENTO

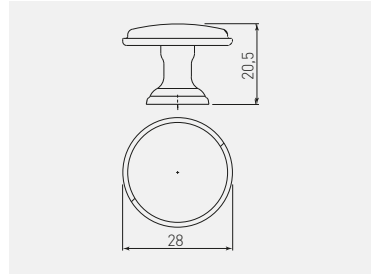

RETRO



|   | antyczny mosiądz<br>antique brass<br>античная латунь | antyczne srebro<br>antique silver<br>античное серебро | antyczna miedź<br>antique copper<br>античная медь | czarny mat<br>black matt<br>чёрный матовый | ZnAl |
|---|--|---|---|--|------|
| <b>gatka</b><br><b>knob</b><br><b>ручка</b> | GZ-CENTO-1-04  | GZ-CENTO-1-07   | GZ-CENTO-1-14                                     | GZ-CENTO-1-20M                             |      |





Gatka SONET  
Knob SONET  
Ручка SONET

NEW

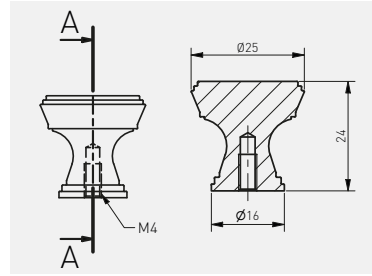

|   |   |  |  |      |
|---|---|--|--|------|
|   | antyczne srebro<br>antique silver<br>античное серебро | złoty szczotkowany<br>brushed gold<br>матовое золото | czarny mat<br>black matt<br>чёрный матовый | ZnAl |
| <b>gatka</b><br><b>knob</b><br><b>ручка</b> | GZ-SONET-1-07   | GZ-SONET-1-18  | GZ-SONET-1-20M                             |      |



Gałka IMPERIA  
Knob IMPERIA  
Ручка IMPERIA

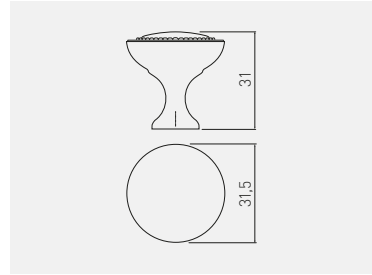

|   |                          |   |  |                                    |
|---|--------------------------|---|--|------------------------------------|
|   | satyna<br>satin<br>сатин | tytan szczotkowany<br>brushed titanium<br>шлифованный титан | czarny mat<br>black matt<br>чёрный матовый | aluminium<br>aluminium<br>алюминий |
| <b>gatka</b><br><b>knob</b><br><b>ручка</b> | GA-IMPER-1-02B           | GA-IMPER-1-11   | GA-IMPER-1-20M                             |                                    |

Uchwyt UZ-71C  
Handle UZ-71C  
Ручка UZ-71C

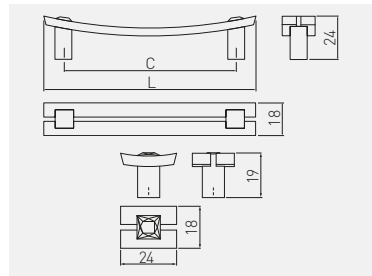

C  
mm

L  
mm



|   |            |                         |  |
|---|------------|-------------------------|--|
|   |            | chrom<br>chrome<br>хром | ZnAl, szkło<br>ZnAl, glass<br>ZnAl, стекло |
| <b>96</b>                                   | <b>118</b> | UZ-71C096-01            |  |
| <b>gatka</b><br><b>knob</b><br><b>ручка</b> |            | GZ-71C024-01            |  |

Uchwyt UZ-02C  
Handle UZ-02C  
Ручка UZ-02C

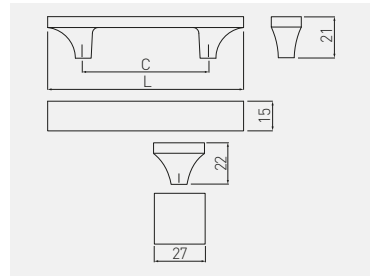

| C<br>mm                | L<br>mm |                         |  |
|------------------------|---------|-------------------------|--|
|                        |         | chrom<br>chrome<br>хром | ZnAl, szkło<br>ZnAl, glass<br>ZnAl, стекло |
| 64                     | 99      | UZ-02C064-01            |  |
| 96                     | 135     | UZ-02C096-01            |  |
| galka<br>knob<br>ручка | 27      | UZ-02CF27-01            |  |

Uchwyt UZ-CRA14\*  
Handle UZ-CRA14\*  
Ручка UZ-CRA14\*

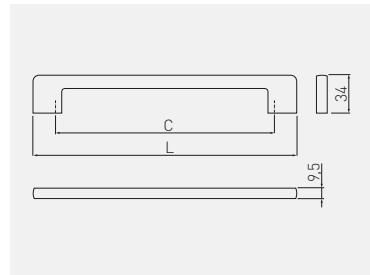



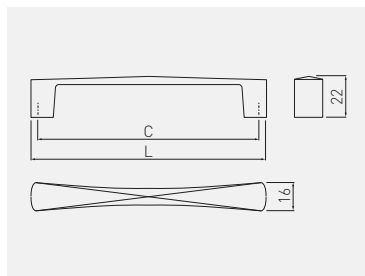

| C<br>mm | L<br>mm |                         |      |
|---------|---------|-------------------------|------|
|         |         | chrom<br>chrome<br>хром | ZnAl |
| 128     | 166     | UZ-CRA14-128            |      |
| 192     | 230     | UZ-CRA14-192            |      |
| 320     | 358     | UZ-CRA14-320            |      |

\* Produkt dostępny na indywidualne zamówienie / Available for special orders / Товар доступен под заказ







Uchwyt COMO  
Handle COMO  
Ручка COMO

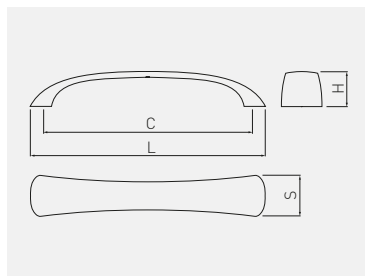

|  C<br>mm |  L<br>mm |  |  |
|---|---|---|---|
|   |   | chrom<br>chrome<br>хром   | ZnAl  |
| <b>96</b>   | <b>104</b>  | UZ-COMO096-01   |   |
| <b>128</b>  | <b>135</b>  | UZ-COMO128-01   |   |
| <b>160</b>  | <b>170</b>  | UZ-COMO160-01   |   |





Uchwyt SIENNA  
Handle SIENNA  
Ручка SIENNA

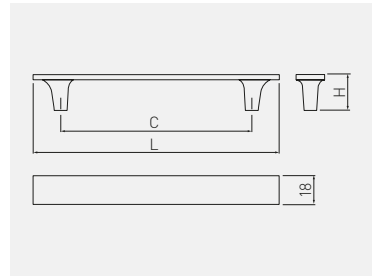

|  C<br>mm |  L<br>mm |  H<br>mm |  S<br>mm |  |  |
|---|---|---|---|---|---|
|   |   |   |   | chrom<br>chrome<br>хром   | ZnAl  |
| <b>96</b>   | <b>111</b>  | <b>21</b>   | <b>23,5</b>   | UZ-SIENNA096-01   |   |
| <b>128</b>  | <b>142</b>  | <b>23</b>   | <b>25</b>   | UZ-SIENNA128-01   |   |
| <b>160</b>  | <b>186</b>  | <b>24,5</b>   | <b>26,5</b>   | UZ-SIENNA160-01   |   |





Uchwyt LUCCA  
Handle LUCCA  
Ручка LUCCA

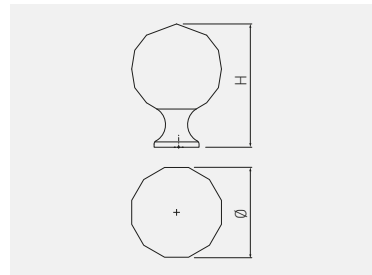

|  C<br>mm |  L<br>mm |  H<br>mm |  |  |
|---|---|---|---|---|
|   |   |   | chrom<br>chrome<br>хром   | ZnAl  |
| 128   | 163   | 23  | UZ-LUCCA128-01  |   |
| 160   | 196   | 23  | UZ-LUCCA160-01  |   |
| 192   | 228   | 23,5  | UZ-LUCCA192-01  |   |



Gałka GZ-CRPA  
Knob GZ-CRPA  
Ручка GZ-CRPA



|  S<br>mm |  H<br>mm |  |  |  |  |
|---|---|---|---|---|--|
|   |   | chrom, biały kryształ<br>chrome, white crystal<br>хром, белый кристалл              | chrom, czarny kryształ<br>chrome, black crystal<br>хром, чёрный кристалл            | mosiądz, biały kryształ<br>brass, white crystal<br>латунь, белый кристалл           | ZnAl, szkło<br>ZnAl, glass<br>ZnAl, стекло |
| 20  | 33  | GZ-CRPA20-01  | -   | -   |  |
| 25  | 37  | GZ-CRPA25-01  | -   | -   |  |
| 30  | 44  | GZ-CRPA30-01  | GZ-CRPA30-A1  | GZ-CRPA30-03  |  |
| 40  | 55  | GZ-CRPA40-01  | -   |   |  |

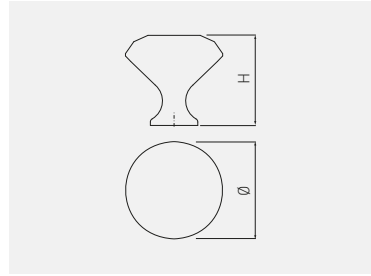

Gatka GZ-CRPB  
 Knob GZ-CRPB  
 Ручка GZ-CRPB



|  mm |  mm |  |  |  |
|--|--|---|---|---|
|  |  | chrom, biały kryształ<br>chrome, white crystal<br>хром, белый кристалл            | chrom, czarny kryształ<br>chrome, black crystal<br>хром, чёрный кристалл          | mosiądz, biały kryształ<br>brass, white crystal<br>латунь, белый кристалл         |
| <b>20</b>  | <b>26</b>  | GZ-CRPB20-01  | -   | -   |
| <b>25</b>  | <b>28</b>  | GZ-CRPB25-01  | GZ-CRPB25-A1  | -   |
| <b>30</b>  | <b>30</b>  | GZ-CRPB30-01  | GZ-CRPB30-A1  | GZ-CRPB30-03  |
| <b>40</b>  | <b>38</b>  | GZ-CRPB40-01  | GZ-CRPB40-A1  | -   |
| ZnAl, szkło<br>ZnAl, glass<br>ZnAl, стекло   |  |   |   |   |

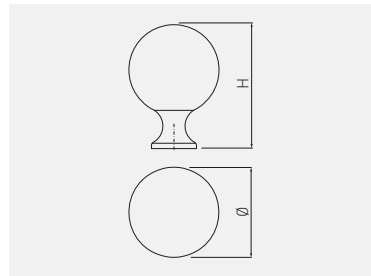



Gatka GZ-CRPC  
 Knob GZ-CRPC  
 Ручка GZ-CRPC

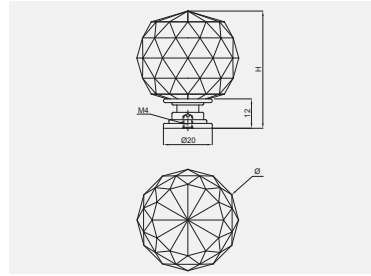

|  mm |  mm |  |  |
|--|--|---|---|
|  |  | chrom, biały kryształ<br>chrome, black crystal<br>хром, белый кристалл              | ZnAl, szkło<br>ZnAl, glass<br>ZnAl, стекло  |
| <b>30</b>  | <b>43</b>  | GZ-CRPC30-01  |   |

Gatka GZ-CRPJ  
 Knob GZ-CRPJ  
 Ручка GZ-CRPJ



|  mm |  mm |  |  |
|--|--|---|---|
|  |  | chrom, biały kryształ<br>chrome, black crystal<br>хром, белый кристалл            | ZnAl, szkło<br>ZnAl, glass<br>ZnAl, стекло  |
| 30   | 43   | ID-GZ-CRPJ30-01   |   |
| 40   | 49   | ID-GZ-CRPJ40-01   |   |



Uchwyt KID  
Handle KID  
Ручка KID



BLOCK



CLOUD



STAR



BUTTON



FLAMING



HEART



CROWN



TWITT

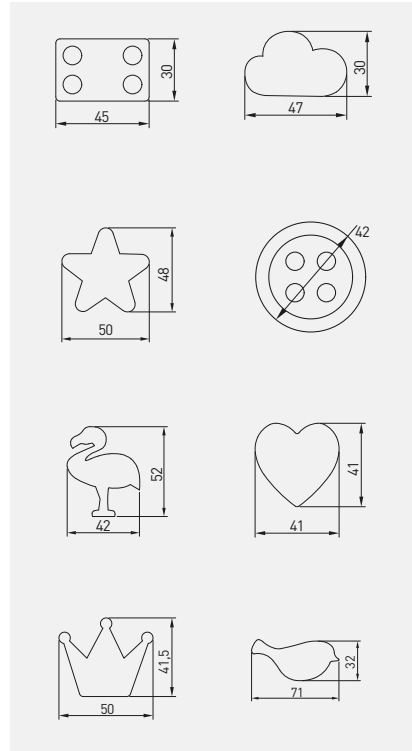

|                 | zielony<br>green<br>зеленый | niebieski<br>blue<br>синий | czerwony<br>red<br>красный | szary<br>grey<br>серый | żółty<br>yellow<br>желтый | różowy<br>pink<br>розовый |   |
|-----------------|-----------------------------|----------------------------|----------------------------|------------------------|---------------------------|---------------------------|---|
| <b>block</b>    | UM-BLOCK-ZL                 | UM-BLOCK-NB                | UM-BLOCK-CZ                | -                      | -                         | -                         | guma,<br>ZnAl<br>rubber,<br>ZnAl<br>резина,<br>ZnAl |
| <b>cloud</b>    | -                           | UM-CLOUD-NB                | -                          | UM-CLOUD-SZ            | -                         | -                         |   |
| <b>star</b>     | -                           | UM-STAR-NB                 | -                          | -                      | UM-STAR-ZT                | UM-STAR-RZ                |   |
| <b>button</b>   | -                           | UM-BUTTON-NB               | -                          | UM-BUTTON-SZ           | -                         | -                         |   |
| <b>flamingo</b> | -                           | -                          | -                          | UM-FLAMING-SZ          | -                         | UM-FLAMING-RZ             |   |
| <b>heart</b>    | -                           | -                          | -                          | -                      | -                         | UM-HEART-RZ               |   |
| <b>crown</b>    | -                           | -                          | -                          | -                      | -                         | UM-CROWN-RZ               |   |
| <b>twitt</b>    | UM-TWITT-ZL                 | -                          | -                          | UM-TWITT-SZ            | -                         | -                         |   |





Uchwyt KID WILD  
Handle KID WILD  
Ручка KID WILD



UM-KID-I-002



UM-KID-P-001



UM-KID-Q-001



UM-KID-U-001

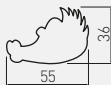

|  |              |  |
|--|--------------|--|
| <b>tygrys / tiger / тигр</b>           | UM-KID-I-002 | guma, ZnAl<br>rubber, ZnAl<br>резина, ZnAl |
| <b>stoń / elephant / слон</b>          | UM-KID-P-001 |  |
| <b>krokodyl / crocodile / крокодил</b> | UM-KID-Q-001 |  |
| <b>panda / panda / панда</b>           | UM-KID-U-001 |  |

Uchwyt KID PLAY  
Handle KID PLAY  
Ручка KID PLAY



UM-KID-C-001



UM-KID-D-001



UM-KID-E-001



|                                    |              |  |
|------------------------------------|--------------|--|
| <b>kwiatek / flower / цветок</b>   | UM-KID-C-001 | guma, ZnAl<br>rubber, ZnAl<br>резина, ZnAl |
| <b>samochód / car / автомобиль</b> | UM-KID-D-001 |  |
| <b>piłka / ball / мяч</b>          | UM-KID-E-001 |  |

Uchwyt KID FARM  
Handle KID FARM  
Ручка KID FARM



UM-KID-W-001



UM-KID-X-001



UM-KID-Z-001



UM-UNICORN-RZ



|  |               |  |
|--|---------------|--|
| <b>konik / horse / лошадь</b>          | UM-KID-W-001  | guma, ZnAl<br>rubber, ZnAl<br>резина, ZnAl |
| <b>królik / rabbit / кролик</b>        | UM-KID-X-001  |  |
| <b>piesek / dog / собака</b>           | UM-KID-Z-001  |  |
| <b>jednorożec / unicorn / единорог</b> | UM-UNICORN-RZ |  |



Wieszak 804  
Hook 804  
Крючок 804

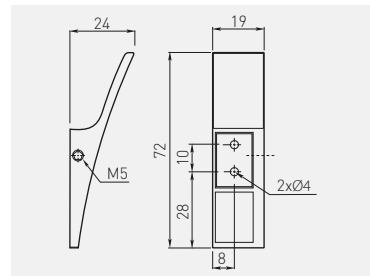

|              |   |      |
|--------------|---|------|
| WZ-804-20-01 | chrom / chrome / хром                                 | ZnAl |
| WZ-804-20-05 | aluminium / aluminium / алюминий                      |      |
| WZ-804-20-06 | stal szcztokowana / brushed steel / шлифованная сталь |      |

Wieszak TOLEDO A0  
Hook TOLEDO A0  
Крючок TOLEDO A0

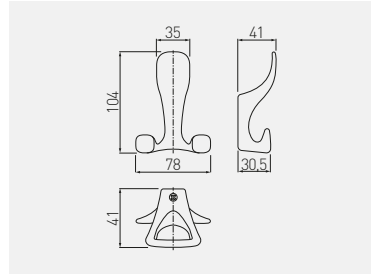

|                 |   |      |
|-----------------|---|------|
| WZ-TOLED-A0-01  | chrom / chrome / хром                                 | ZnAl |
| WZ-TOLED-A0-02  | satyna / satin / сатин                                |      |
| WZ-TOLED-A0-05  | aluminium / aluminium / алюминий                      |      |
| WZ-TOLED-A0-06  | stal szczotkowana / brushed steel / шлифованная сталь |      |
| WZ-TOLED-A0-20M | czarny mat / black matt / чёрный матовый              |      |

Wieszak TOLEDO B0  
Hook TOLEDO B0  
Крючок TOLEDO B0

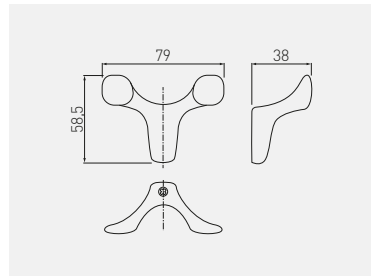

|                 |   |      |
|-----------------|---|------|
| WZ-TOLED-B0-01  | chrom / chrome / хром                                 | ZnAl |
| WZ-TOLED-B0-02  | satyna / satin / сатин                                |      |
| WZ-TOLED-B0-05  | aluminium / aluminium / алюминий                      |      |
| WZ-TOLED-B0-06  | stal szczotkowana / brushed steel / шлифованная сталь |      |
| WZ-TOLED-B0-20M | czarny mat / black matt / чёрный матовый              |      |

Wieszak TOLEDO C0  
 Hook TOLEDO C0  
 Крючок TOLEDO C0

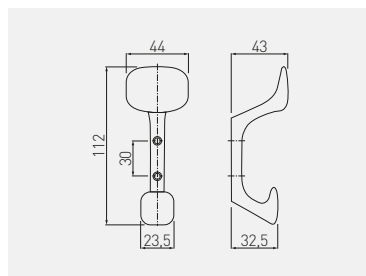

|                 |   |      |
|-----------------|---|------|
| WZ-TOLED-C0-01  | chrom / chrome / хром                                 | ZnAl |
| WZ-TOLED-C0-02  | satyna / satin / сатин                                |      |
| WZ-TOLED-C0-05  | aluminium / aluminium / алюминий                      |      |
| WZ-TOLED-C0-06  | stal szczotkowana / brushed steel / шлифованная сталь |      |
| WZ-TOLED-C0-20M | czarny mat / black matt / чёрный матовый              |      |

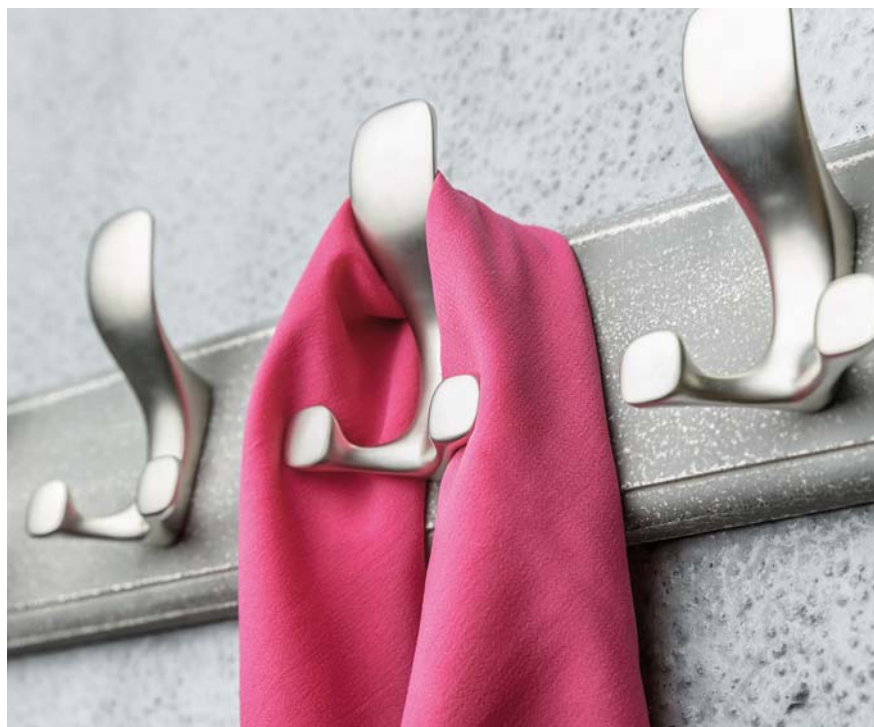

Wieszak WALENCIA  
Hook WALENCIA  
Крючок WALENCIA

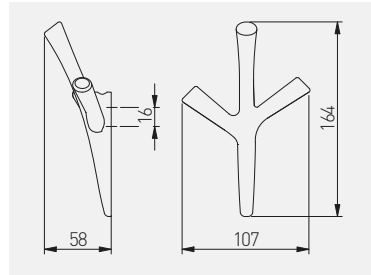

|                 |   |      |
|-----------------|---|------|
| WZ-WALENCIA-01  | chrom / chrome / хром                                 | ZnAl |
| WZ-WALENCIA-06  | stal szczotkowana / brushed steel / шлифованная сталь |      |
| WZ-WALENCIA-20M | czarny mat / black matt / чёрный матовый              |      |

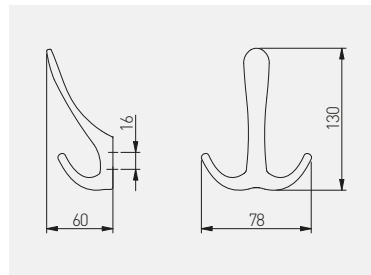

Wieszak CORDOBA  
Hook CORDOBA  
Крючок CORDOBA



|                |   |      |
|----------------|---|------|
| WZ-CORDOBA-01  | chrom / chrome / хром                                 | ZnAl |
| WZ-CORDOBA-06  | stal szczotkowana / brushed steel / шлифованная сталь |      |
| WZ-CORDOBA-20M | czarny mat / black matt / чёрный матовый              |      |

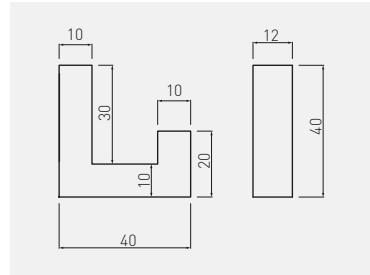

Wieszak K2201  
Hook K2201  
Крючок K2201

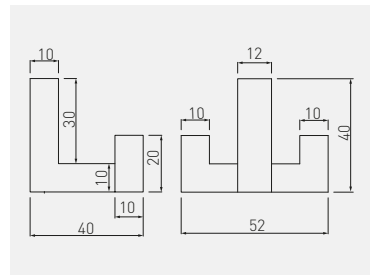

|   |   |   |
|---|---|---|
|  |  |  |
| WZ-K2201-01   | chrom / chrome / хром   | ZnAl  |
| WZ-K2201-06   | stal szczotkowana / brushed steel / шлифованная сталь                             |   |
| WZ-K2201-CZ   | czarny / black / чёрный   |   |

Wieszak K2202  
Hook K2202  
Крючок K2202



|   |   |   |
|---|---|---|
|  |  |  |
| WZ-K2202-01   | chrom / chrome / хром   | ZnAl  |
| WZ-K2202-06   | stal szczotkowana / brushed steel / шлифованная сталь                               |   |
| WZ-K2202-CZ   | czarny / black / чёрный   |   |

Wieszak K23-A0  
Hook K23-A0  
Крючок K23-A0

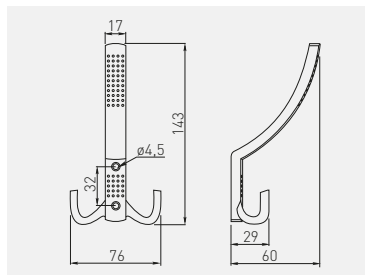

|               |   |      |
|---------------|---|------|
| WZ-A0-K23-01  | chrom / chrome / хром                                 | ZnAl |
| WZ-A0-K23-02  | satyna / satin / сатин                                |      |
| WZ-A0-K23-03  | mosiądz / brass / латунь                              |      |
| WZ-A0-K23-04  | antyczny mosiądz / antique brass / античная латунь    |      |
| WZ-A0-K23-05  | aluminium / aluminium / алюминий                      |      |
| WZ-A0-K23-06* | stal szczotkowana / brushed steel / шлифованная сталь |      |
| WZ-A0-K23-07  | antyczne srebro / antique silver / античное серебро   |      |
| WZ-A0-K23-20  | czarny mat / black matt / чёрный матовый              |      |

\*Dostępny na zamówienie / Available only for individual order / Доступен под заказ

Wieszak K23-B0  
Hook K23-B0  
Крючок K23-B0

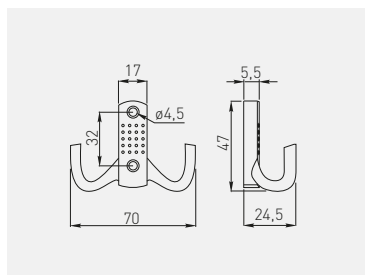

|               |   |      |
|---------------|---|------|
| WZ-B0-K23-01  | chrom / chrome / хром                                 | ZnAl |
| WZ-B0-K23-02  | satyna / satin / сатин                                |      |
| WZ-B0-K23-03  | mosiądz / brass / латунь                              |      |
| WZ-B0-K23-04  | antyczny mosiądz / antique brass / античная латунь    |      |
| WZ-B0-K23-05  | aluminium / aluminium / алюминий                      |      |
| WZ-B0-K23-06* | stal szczotkowana / brushed steel / шлифованная сталь |      |
| WZ-B0-K23-07  | antyczne srebro / antique silver / античное серебро   |      |
| WZ-B0-K23-20  | czarny mat / black matt / чёрный матовый              |      |

\*Dostępny na zamówienie / Available only for individual order / Доступен под заказ



Wieszak K23-D1  
Hook K23-D1  
Крючок K23-D1

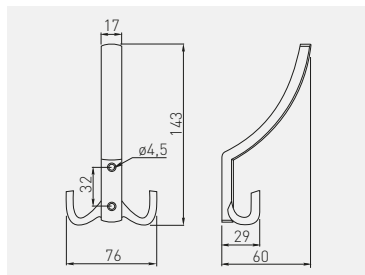

|              |   |      |
|--------------|---|------|
| WZ-K23-D1-01 | chrom / chrome / хром                                 | ZnAl |
| WZ-K23-D1-02 | satyna / satin / сатин                                |      |
| WZ-K23-D1-05 | aluminium / aluminium / алюминий                      |      |
| WZ-K23-D1-06 | stal szczotkowana / brushed steel / шлифованная сталь |      |

Wieszak K23-E1  
Hook K23-E1  
Крючок K23-E1

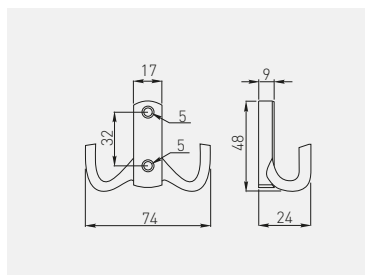

|              |   |      |
|--------------|---|------|
| WZ-K23-E1-01 | chrom / chrome / хром                                 | ZnAl |
| WZ-K23-E1-05 | aluminium / aluminium / алюминий                      |      |
| WZ-K23-E1-06 | stal szczotkowana / brushed steel / шлифованная сталь |      |

Wieszak K24-A0  
Hook K24-A0  
Крючок K24-A0

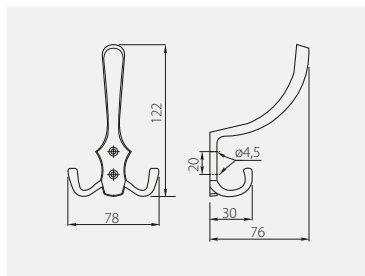

|              |   |      |
|--------------|---|------|
| WZ-A0-K24-01 | chrom / chrome / хром                               | ZnAl |
| WZ-A0-K24-02 | satyna / satin / сатин                              |      |
| WZ-A0-K24-03 | mosiądz / brass / латунь                            |      |
| WZ-A0-K24-04 | antyczny mosiądz / antique brass / античная латунь  |      |
| WZ-A0-K24-05 | aluminium / aluminium / алюминий                    |      |
| WZ-A0-K24-07 | antyczne srebro / antique silver / античное серебро |      |
| WZ-A0-K24-20 | czarny mat / black matt / чёрный матовый            |      |

Wieszak K24-B0  
Hook K24-B0  
Крючок K24-B0

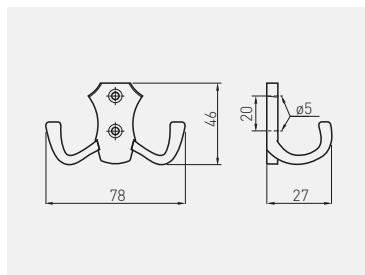

|              |   |      |
|--------------|---|------|
| WZ-B0-K24-01 | chrom / chrome / хром                               | ZnAl |
| WZ-B0-K24-02 | satyna / satin / сатин                              |      |
| WZ-B0-K24-03 | mosiądz / brass / латунь                            |      |
| WZ-B0-K24-04 | antyczny mosiądz / antique brass / античная латунь  |      |
| WZ-B0-K24-05 | aluminium / aluminium / алюминий                    |      |
| WZ-B0-K24-07 | antyczne srebro / antique silver / античное серебро |      |
| WZ-B0-K24-20 | czarny mat / black matt / чёрный матовый            |      |



Wieszak K24-C0  
Hook K24-C0  
Крючок K24-C0

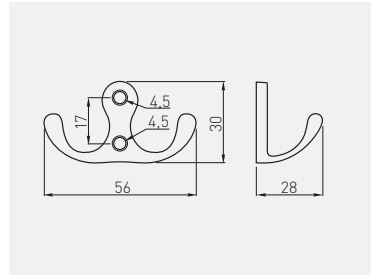

|              |  |      |
|--------------|--|------|
| WZ-C0-K24-01 | chrom / chrome / хром                              | ZnAl |
| WZ-C0-K24-02 | satyna / satin / сатин                             |      |
| WZ-C0-K24-03 | mosiądz / brass / латунь                           |      |
| WZ-C0-K24-04 | antyczny mosiądz / antique brass / античная латунь |      |
| WZ-C0-K24-05 | aluminium / aluminium / алюминий                   |      |
| WZ-C0-K24-20 | czarny mat / black matt / чёрный матовый           |      |

Wieszak MALAGA A0  
Hook MALAGA A0  
Крючок MALAGA A0

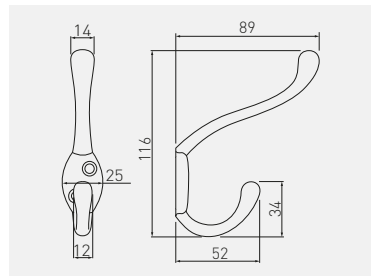

|                |                                  |                                  |
|----------------|----------------------------------|----------------------------------|
| WA-MALAG-A0-01 | chrom / chrome / хром            | aluminium / aluminium / алюминий |
| WA-MALAG-A0-02 | satyna / satin / сатин           |                                  |
| WA-MALAG-A0-05 | aluminium / aluminium / алюминий |                                  |
| WA-MALAG-A0-20 | czarny / black / чёрный          |                                  |

Wieszak MALAGA B0  
Hook MALAGA B0  
Крючок MALAGA B0

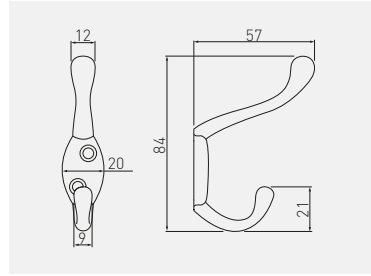

|                |                                  |                                    |
|----------------|----------------------------------|------------------------------------|
| WA-MALAG-B0-01 | chrom / chrome / хром            | aluminium<br>aluminium<br>алюминий |
| WA-MALAG-B0-02 | satyna / satin / сатин           |                                    |
| WA-MALAG-B0-05 | aluminium / aluminium / алюминий |                                    |
| WA-MALAG-B0-20 | czarny / black / чёрный          |                                    |

Wieszak MALAGA C0  
Hook MALAGA C0  
Крючок MALAGA C0

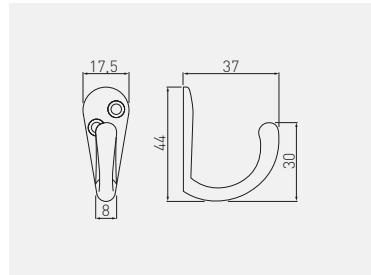

|                |                                  |      |
|----------------|----------------------------------|------|
| WZ-MALAG-C0-01 | chrom / chrome / хром            | ZnAl |
| WZ-MALAG-C0-02 | satyna / satin / сатин           |      |
| WZ-MALAG-C0-05 | aluminium / aluminium / алюминий |      |
| WZ-MALAG-C0-20 | czarny / black / чёрный          |      |

Wieszak E18  
Hook E18  
Крючок E18

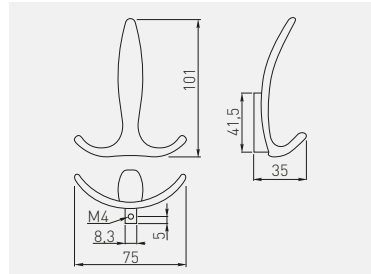

|              |   |      |
|--------------|---|------|
| WZ-E-018-01  | chrom / chrome / хром                                 | ZnAl |
| WZ-E-018-02  | satyna / satin / сатин                                |      |
| WZ-E-018-05  | aluminium / aluminium / алюминий                      |      |
| WZ-E-018-06  | stal szczotkowana / brushed steel / шлифованная сталь |      |
| WZ-E-018-20M | czarny mat / black matt / чёрный матовый              |      |

Wieszak CORUNA-D  
Hook CORUNA-D  
Крючок CORUNA-D

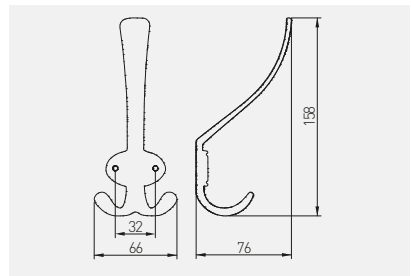

|                 |   |      |
|-----------------|---|------|
| WZ-CORUNA-D-04  | antyczny mosiądz / antique brass / античная латунь  | ZnAl |
| WZ-CORUNA-D-07  | antyczne srebro / antique silver / античное серебро |      |
| WZ-CORUNA-D-17  | brąz / bronze / коричневый                          |      |
| WZ-CORUNA-D-20M | czarny mat / black matt / чёрный матовый            |      |

Wieszak CORUNA-M  
Hook CORUNA-M  
Крючок CORUNA-M

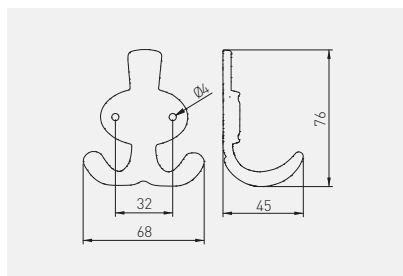

|                 |   |      |
|-----------------|---|------|
| WZ-CORUNA-M-04  | antyczny mosiądz / antique brass / античная латунь  | ZnAl |
| WZ-CORUNA-M-07  | antyczne srebro / antique silver / античное серебро |      |
| WZ-CORUNA-M-17  | brąz / bronze / коричневый                          |      |
| WZ-CORUNA-M-20M | czarny mat / black matt / чёрный матовый            |      |



Wieszak MADRYT  
Hook MADRYT  
Крючок MADRYT

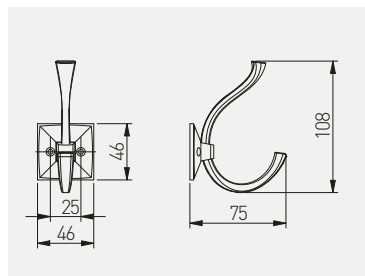

|               |   |      |
|---------------|---|------|
| WZ-MADRYT-04  | antyczny mosiądz / antique brass / античная латунь  | ZnAl |
| WZ-MADRYT-07  | antyczne srebro / antique silver / античное серебро |      |
| WZ-MADRYT-15  | antyczna miedź / antique copper / античная медь     |      |
| WZ-MADRYT-20M | czarny mat / black matt / чёрный матовый            |      |

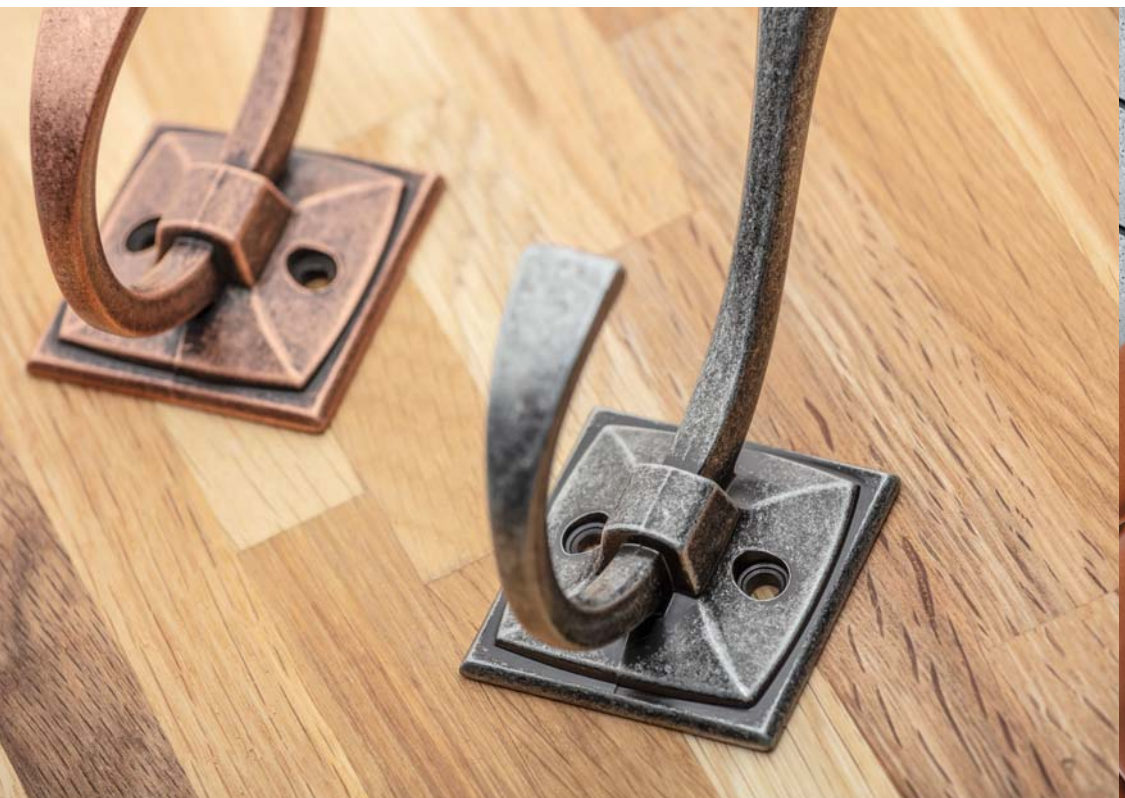



Wieszak CAPITAL  
 Hook CAPITAL  
 Крючок CAPITAL

NEW

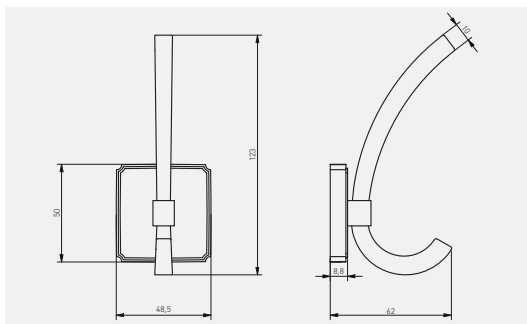

|                |  |      |
|----------------|--|------|
| WZ-CAPITAL-18  | złoty szczotkowany<br>brushed gold<br>матовое золото | ZnAl |
| WZ-CAPITAL-20M | czarny mat<br>black matt<br>чёрный матовый           |      |

RETRO



Wieszak CRAFT  
Hook CRAFT  
Крючок CRAFT

NEW

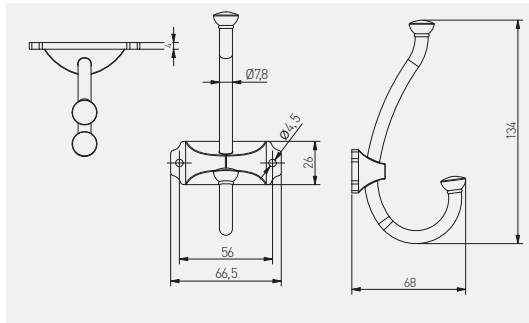

|              |   |      |
|--------------|---|------|
| WZ-CRAFT-04  | antyczny mosiądz / antique brass / античная латунь  | ZnAl |
| WZ-CRAFT-07  | antyczne srebro / antique silver / античное серебро |      |
| WZ-CRAFT-15  | antyczna miedź / antique copper / античная медь     |      |
| WZ-CRAFT-20M | czarny mat / black matt / чёрный матовый            |      |



Wieszak ORVIETO A0  
 Hook ORVIETO A0  
 Крючок ORVIETO A0

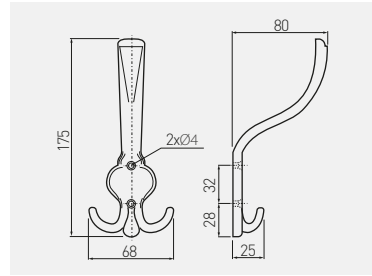

WZ-ORVIE-A0-09



antyczny mosiądz szczotkowany  
 antique brushed brass  
 античная шлифованная латунь



ZnAl

Wieszak ORVIETO B0  
 Hook ORVIETO B0  
 Крючок ORVIETO B0

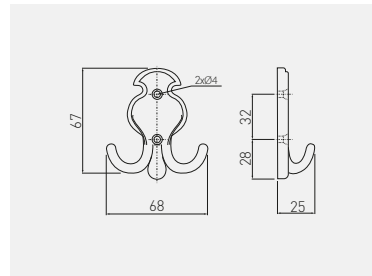

WZ-ORVIE-B0-09



antyczny mosiądz szczotkowany  
 antique brushed brass  
 античная шлифованная латунь



ZnAl

Wieszak K24  
Hook K24  
Крючок K24

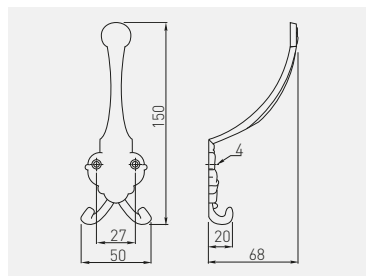

WZ-00-K24-04

antyczny mosiądz / antique brass / античная латунь

ZnAl

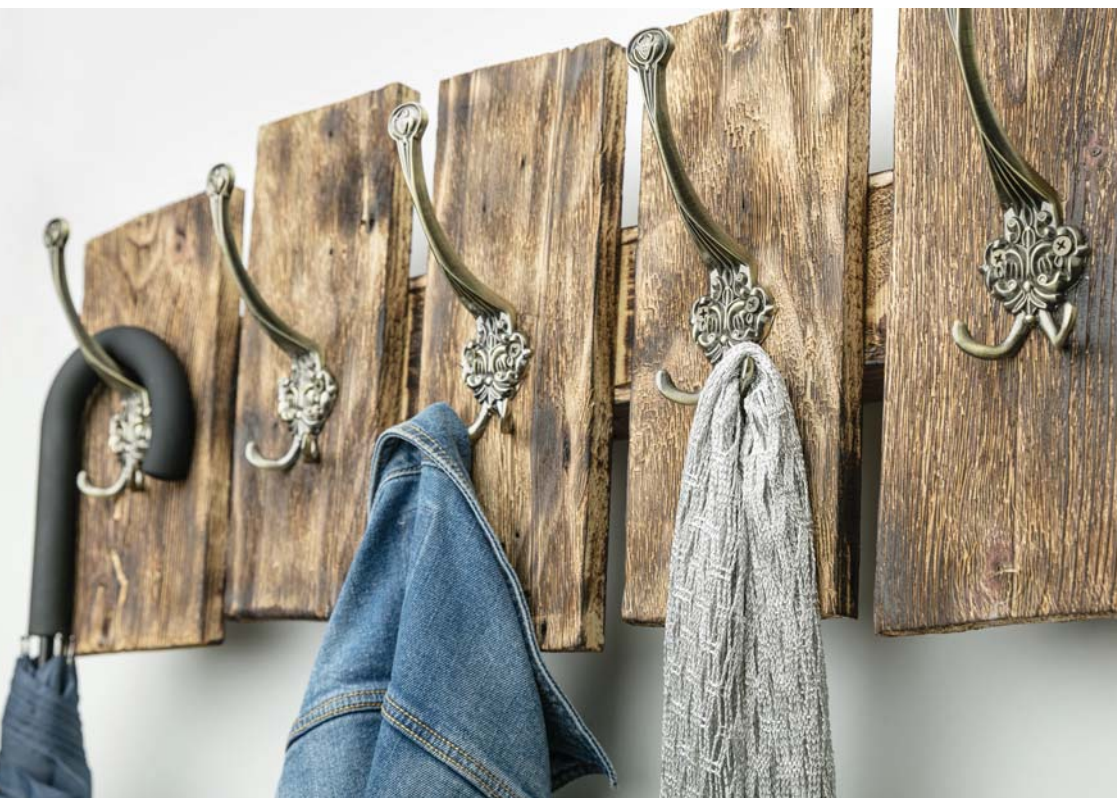

Wieszaki KID  
Hook KID  
Крючок KID



BLOCK



CLOUD



STAR



UNICORN



BALL

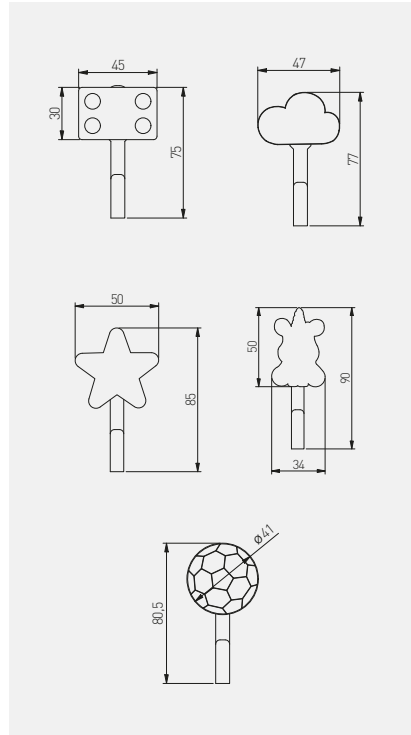

KID



|         | zielony<br>green<br>зеленый | niebieski<br>blue<br>синий | czerwony<br>red<br>красный | szary<br>grey<br>серый | żółty<br>yellow<br>желтый | czarno-biały<br>black & white<br>черно-белый | różowy<br>pink<br>розовый |   |
|---------|-----------------------------|----------------------------|----------------------------|------------------------|---------------------------|--|---------------------------|---|
| block   | WM-BLOCK-ZL                 | WM-BLOCK-NB                | WM-BLOCK-CZ                | -                      | -                         | -  | -                         |   |
| cloud   | -                           | WM-CLOUD-NB                | -                          | WM-CLOUD-SZ            | -                         | -  | -                         | guma,<br>ZnAl<br>rubber,<br>ZnAl<br>резина,<br>ZnAl |
| star    | -                           | WM-STAR-NB                 | -                          | -                      | WM-STAR-ZT                | -  | WM-STAR-RZ                |   |
| unicorn | -                           | -                          | -                          | -                      | -                         | -  | WM-UNICORN-RZ             |   |
| ball    | -                           | -                          | -                          | -                      | -                         | WM-BALL-CZ-B                                 | -                         |   |

Podpórka pod półkę BELT  
Shelf support BELT  
Полкодержатель BELT

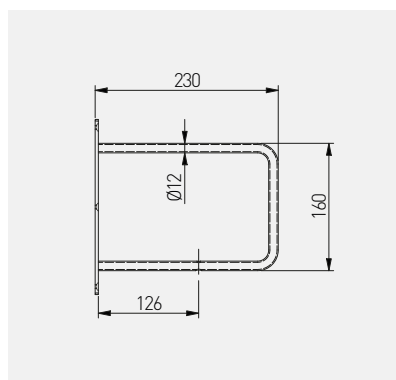

|   |   |   |   |
|---|---|---|---|
|  |  |  |  |
| PP-BELT-20M   | czarny / black / чёрный   | stal / steel / сталь  | 30  |

Podpórka pod półkę FLAT  
Shelf support FLAT  
Полкодержатель FLAT

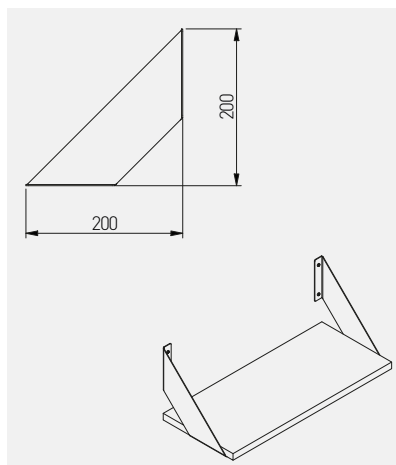

|   |   |   |   |
|---|---|---|---|
|  |  |  |  |
| PP-FLAT-20M   | czarny / black / чёрный   | stal / steel / сталь  | 15  |





Podpórka pod półkę GALA  
Shelf support GALA  
Полкодержатель GALA

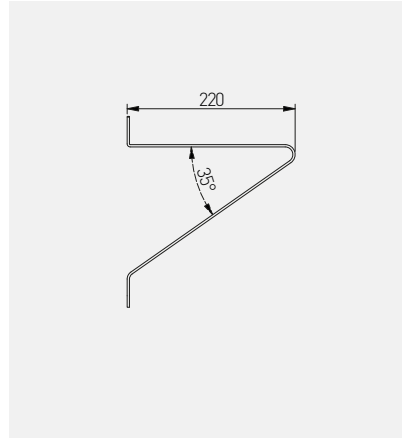

|   |   |   |   |
|---|---|---|---|
|  |  |  |  |
| PP-GALA-20M   | czarny / black / чёрный   | stal / steel / сталь  | 30  |

Podpórka pod półkę GINO  
Shelf support GINO  
Полкодержатель GINO

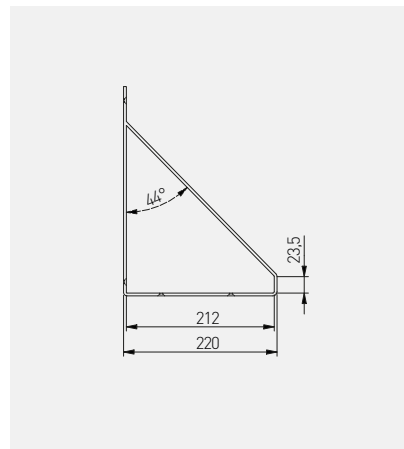

|   |   |   |   |
|---|---|---|---|
|  |  |  |  |
| PP-GINO-20M   | czarny / black / чёрный   | stal / steel / сталь  | 30  |





Podpórka pod półkę INGRID  
Shelf support INGRID  
Полкодержатель INGRID

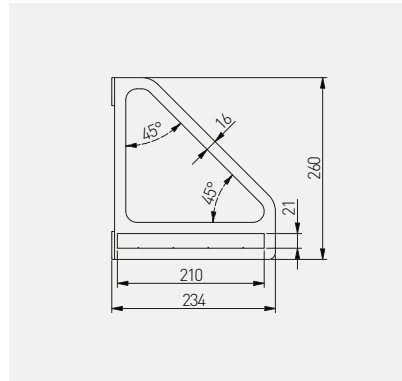

PP-INGRID-20M



czarny / black / чёрный



stal / steel / сталь



20

Podpórka pod półkę NEO  
Shelf support NEO  
Полкодержатель NEO

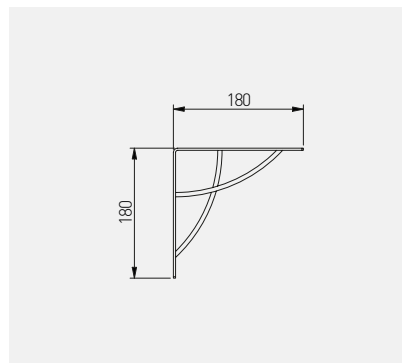

PP-NEO-20M



czarny / black / чёрный



stal / steel / сталь



20



Podpórka pod rótkę BAR  
Shelf support BAR  
Полкодержатель BAR

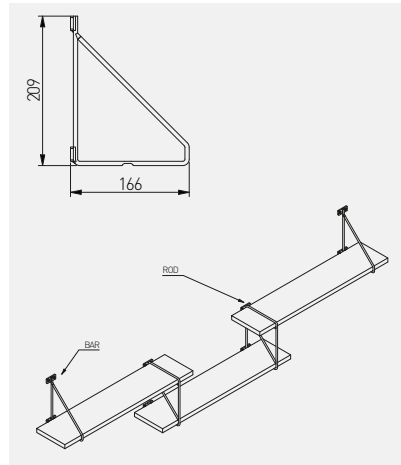

|   |   |   |   |
|---|---|---|---|
|  |  |  |  |
| PP-BAR-20M  | czarny / black / чёрный   | stal / steel / сталь  | 20  |

Podpórka pod rótkę ROD  
Shelf support ROD  
Полкодержатель ROD

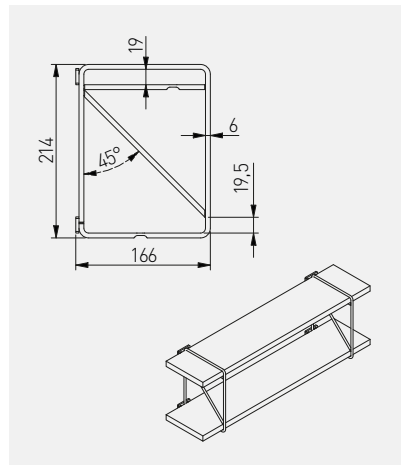

|   |   |   |   |
|---|---|---|---|
|  |  |  |  |
| PP-ROD-20M  | czarny / black / чёрный   | stal / steel / сталь  | 20  |

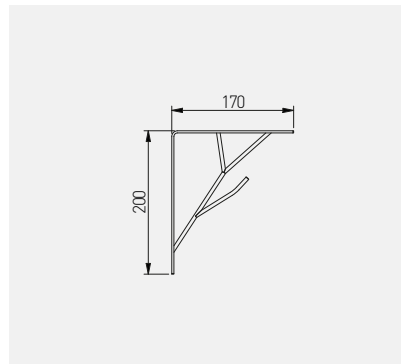

Podpórka pod półkę TREE  
Shelf support TREE  
Полкодержатель TREE



|   |   |   |   |
|---|---|---|---|
|  |  |  |  |
| PP-TREE-20M   | czarny / black / чёрный   | stal / steel / сталь  | 20  |

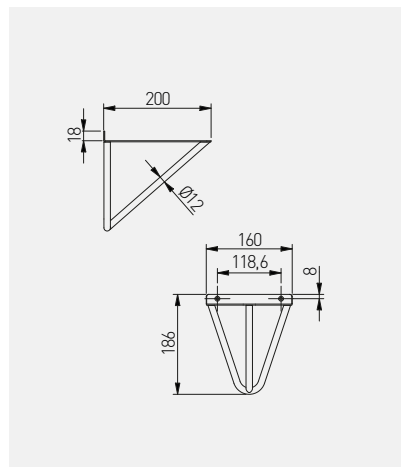



Podpórka pod półkę WIRE  
Shelf support WIRE  
Полкодержатель WIRE

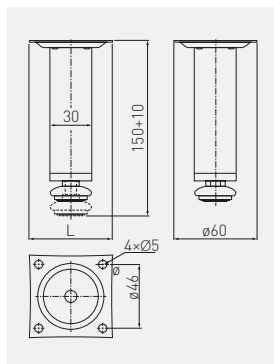

|   |   |   |   |
|---|---|---|---|
|  |  |  |  |
| PP-WIRE-20M   | czarny / black / чёрный   | stal / steel / сталь  | 30  |



Nóżka BD-150 z regulacją  
Adjustable leg BD-150  
Ножка BD-150 с регулировкой



|              |  |  H<br>mm |  |  |  |
|--------------|---|---|---|---|---|
| NM-BD-150-01 |   | 150 + 10  | chrom / chrome / хром   | stal / steel / сталь  | 80  |
| NM-BD-150-02 |   |   | satyna / satin / сатин  |   |   |

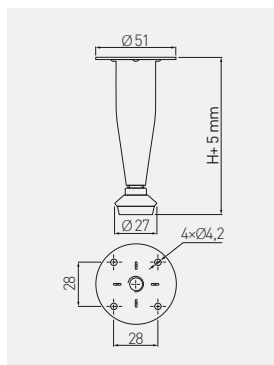

Nóżka BD-03 z regulacją  
Adjustable leg BD-03  
Ножка BD-03 с регулировкой



|              |  |  H<br>mm |  |  |  |
|--------------|---|---|---|---|---|
| NM-BD-003-01 |   | 100 + 5   | chrom / chrome / хром   | stal / steel / сталь  | 100   |
| NM-BD-003-02 |   |   | satyna / satin / сатин  |   |   |

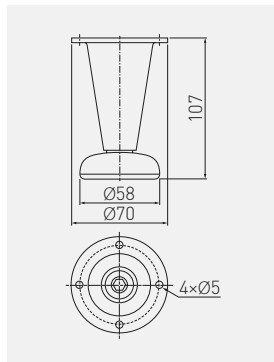



Nóżka BD-780  
Leg BD-780  
Ножка BD-780

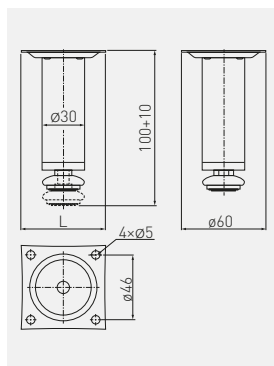

|              |  |  H<br>mm |  |  |  |
|--------------|---|---|---|---|---|
| NM-BD-780-M1 |   | 107   | chrom / chrome / хром   | stal / steel / сталь  | 50  |
| NM-BD-780-M2 |   |   | satyna / satin / сатин  |   |   |
| NM-BD-780-M5 |   |   | aluminium / aluminium / алюминий  |   |   |





Nóżka BD-100 z regulacją  
Adjustable leg BD-100  
Ножка BD-100 с регулировкой

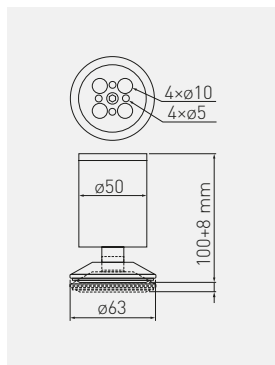

|              |  |  H<br>mm |  |  |  |
|--------------|---|---|---|---|---|
| NM-BD-100-01 |   | 100 + 10  | chrom / chrome / хром   | stal<br>steel<br>сталь  | 100   |
| NM-BD-100-02 |   |   | satyna / satin / сатин  |   |   |
| NM-BD-100-05 |   |   | aluminium / aluminium / алюминий  |   |   |
| NM-BD-100-06 |   |   | stal szcztokowana / brushed steel / шлифованная сталь                               |   |   |





Nóżka BD-762 z regulacją  
Adjustable leg BD-762  
Ножка BD-762 с регулировкой

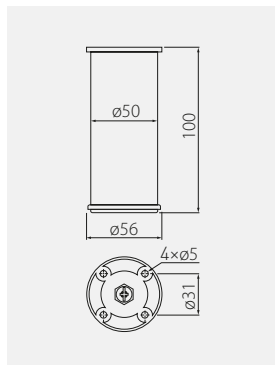

|   |   |   |   |   |
|---|---|---|---|---|
|  | <br>mm |  |  |  |
| NM-BD-762-01  | 100 + 8   | chrom / chrome / хром   | ZnAl, stal<br>ZnAl, steel<br>ZnAl, сталь  | 50  |
| NM-BD-762-05  |   | aluminium / aluminium / алюминий  |   |   |

Nóżka BD-867  
Leg BD-867  
Ножка BD-867



|   |   |   |   |   |
|---|---|---|---|---|
|  | <br>mm |  |  |  |
| NM-BD867-100  | 100   | aluminium / aluminium / алюминий  | aluminium / aluminium / алюминий  | 50  |



Nóżka BD-868  
 Leg BD-868  
 Ножка BD-868

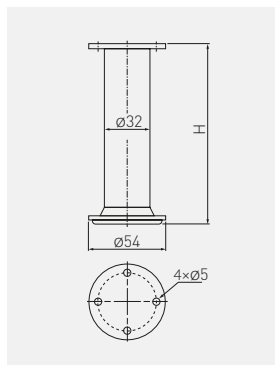

|              |     |                                  |                                  |    |
|--------------|-----|----------------------------------|----------------------------------|----|
| NM-BD868-100 | 100 | aluminium / aluminium / алюминий | aluminium / aluminium / алюминий | 50 |
| NM-BD868-150 | 150 |                                  |                                  |    |



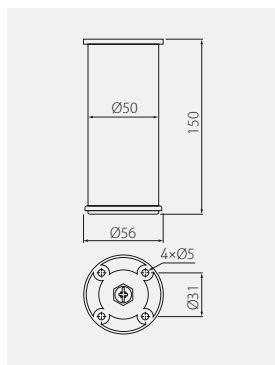

Nóżka BD-869  
 Leg BD-869  
 Ножка BD-869

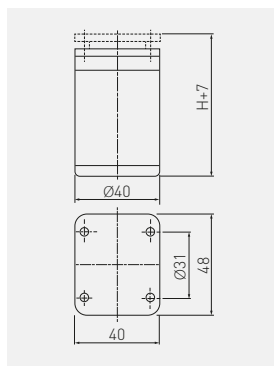

|              |     |                                  |                                  |    |
|--------------|-----|----------------------------------|----------------------------------|----|
| NM-BD869-150 | 150 | aluminium / aluminium / алюминий | aluminium / aluminium / алюминий | 50 |
|--------------|-----|----------------------------------|----------------------------------|----|





Nóżka DAP-77 z regulacją  
Adjustable leg DAP-77  
Ножка DAP-77 с регулировкой высоты

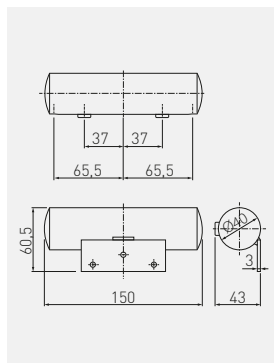

|  |  H<br>mm |  |  |
|---|---|---|---|
| NM-DAP77-60   | 60 + 7  | aluminium / aluminium / алюминий  | aluminium, tworzywo aluminium, plastic<br>алюминий, пластмасса                    |
| NM-DAP77-100  | 100 + 7   |   |   |
| NM-DAP77-150  | 150 + 7   |   |   |





Nóżka BAHIA  
Leg BAHIA  
Ножка BAHIA

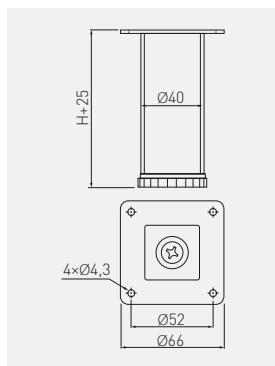

|  |  H<br>mm |  |  |
|---|---|---|---|
| NM-BAHIA40-150-01   | 43  | chrom / chrome / хром   | stal, tworzywo steel, plastic<br>сталь, пластмасса                                  |





Nóżka SQ-40 z regulacją  
Adjustable leg SQ-40  
Ножка SQ-40 с регулировкой высоты

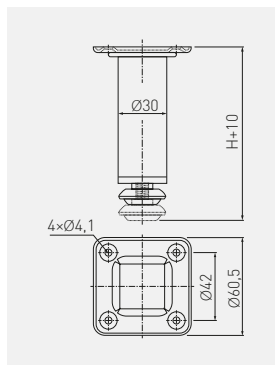

|  |  H<br>mm |  |  |  |
|---|---|---|---|---|
| NM-SQ40ADJ-060  | 60 + 25   | chrom / chrome / хром   | stal / steel / сталь  | 100   |
| NM-SQ40ADJ-100  | 100 + 25  | chrom / chrome / хром   |   | 50  |

Nóżka SQA z regulacją  
Adjustable leg SQA  
Ножка SQA с регулировкой высоты



|  |  H<br>mm |  |  |  |
|---|---|---|---|---|
| NM-SQA100-01  | 100 + 10  | chrom / chrome / хром   | stal / steel / сталь  | 100   |
| NM-SQA150-01*   | 150 + 10  |   |   |   |

\* Dostępny na zamówienie / Available only for individual order / Доступен под заказ

Nóżka BD-727  
Leg BD-727  
Ножка BD-727

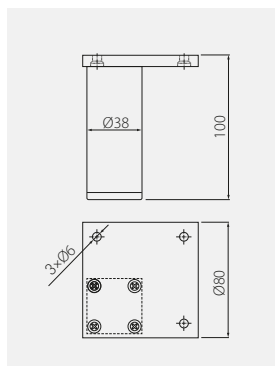

|              |     |                                  |                                  |    |
|--------------|-----|----------------------------------|----------------------------------|----|
| NM-BD727-100 | 100 | aluminium / aluminium / алюминий | aluminium / aluminium / алюминий | 50 |
|--------------|-----|----------------------------------|----------------------------------|----|

Nóżka BD-739  
Leg BD-739  
Ножка BD-739

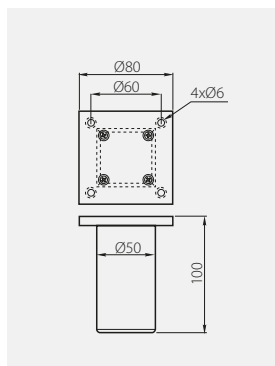

|              |     |                                  |                                  |    |
|--------------|-----|----------------------------------|----------------------------------|----|
| NM-BD-739-05 | 100 | aluminium / aluminium / алюминий | aluminium / aluminium / алюминий | 50 |
|--------------|-----|----------------------------------|----------------------------------|----|

Nóżka DAK-27 z regulacją  
Adjustable leg DAK-27  
Ножка DAK-27 с регулировкой высоты

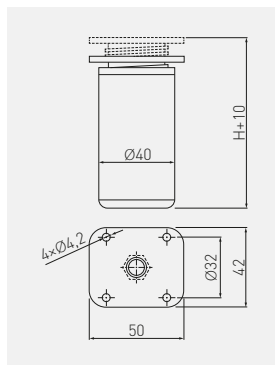

|              |  |  H<br>mm |  |  |  |
|--------------|---|---|---|---|---|
| NM-DAK27-060 |   | 60 + 10   | aluminium<br>aluminium<br>алюминий  | aluminium, tworzywo<br>aluminium, plastic<br>алюминий, пластмасса                 | 100   |
| NM-DAK27-080 |   | 80 + 10   |   |   |   |
| NM-DAK27-100 |   | 100 + 10  |   |   |   |
| NM-DAK27-120 |   | 120 + 10  |   |   |   |
| NM-DAK27-150 |   | 150 + 10  |   |   |   |

Nóżka NACK z regulacją  
Adjustable leg NACK  
Ножка NACK с регулировкой высоты

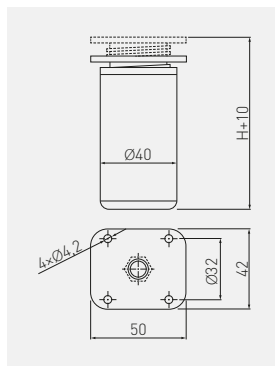

|                 |  |  H<br>mm |  |  |  |
|-----------------|---|---|---|---|---|
| NM-NACK27651-06 |   | 60 + 10   | chrom<br>chrome<br>хром   | tworzywo, aluminium<br>plastic, aluminium<br>пластмасса, алюминий                   | 100   |

Nóżka BD-01  
Leg BD-01  
Ножка BD-01

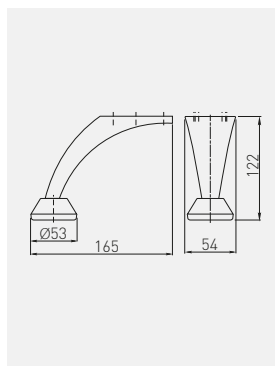

|   |   |   |   |   |
|---|---|---|---|---|
|  | <br>mm |  |  |  |
| NM-BD-001-M1B   | 122   | chrom / chrome / хром   | stal / steel / сталь  | 80  |

Nóżka BD-712  
Leg BD-712  
Ножка BD-712

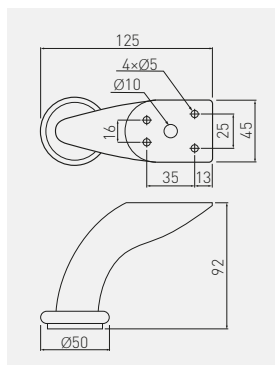



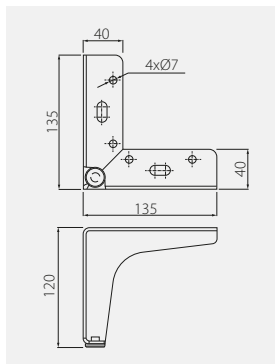

|   |   |   |   |   |
|---|---|---|---|---|
|  | <br>mm |  |  |  |
| NM-BD-712-M1  | 92  | chrom / chrome / хром   | stal / steel / сталь  | 50  |

\*Dostępny na zamówienie / Available only for individual order / Доступен под заказ

Nóżka STGY 135  
Leg STGY 135  
Ножка STGY 135



|  |  H<br>mm |  |  |  |
|---|---|---|---|---|
| NM-STGY135-100-01   | 100   | chrom / chrome / хром   | stal, tworzywo<br>steel, plastic<br>сталь, пластик                                | 50  |
| NM-STGY135-130-01*  | 130   |   |   |   |
| NM-STGY135-150-01*  | 150   |   |   |   |

\*Dostępny na zamówienie / Available only for individual order / Доступен под заказ



Nóżka STOMP  
Leg STOMP  
Ножка STOMP

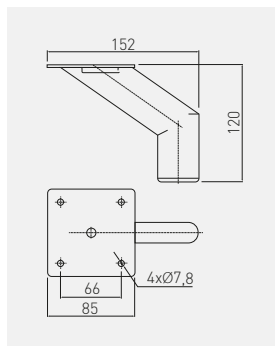

|                  |     |   |                        |     |
|------------------|-----|---|------------------------|-----|
| NM-STOMP-100-01* | 100 | chrom / chrome / хром                                 | stal<br>steel<br>сталь | 100 |
| NM-STOMP-120-10* | 120 | biały / white / белый                                 |                        |     |
| NM-STOMP-120-20  |     | czarny / black / чёрный                               |                        |     |
| NM-STOMP-130-01* | 130 | chrom / chrome / хром                                 | stal<br>steel<br>сталь | 60  |
| NM-STOMP-130-06* |     | stal szorstkowana / brushed steel / шлифованная сталь |                        |     |
| NM-STOMP-130-20* | 150 | czarny / black / чёрный                               |                        |     |
| NM-STOMP-150-01* |     | chrom / chrome / хром                                 |                        |     |
| NM-STOMP-160-01* | 160 | chrom / chrome / хром                                 | stal<br>steel<br>сталь | 60  |
| NM-STOMP-160-06* |     | stal szorstkowana / brushed steel / шлифованная сталь |                        |     |
| NM-STOMP-160-20* |     | czarny / black / чёрный                               |                        |     |

\*Dostępny na zamówienie / Available only for individual order / Доступен под заказ

Nóżka MDN-D4  
Leg MDN-D4  
Ножка MDN-D4

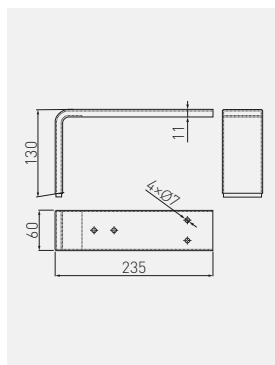

|              |     |                       |                      |    |
|--------------|-----|-----------------------|----------------------|----|
| NM-MDN-D4-01 | 130 | chrom / chrome / хром | stal / steel / сталь | 25 |
|--------------|-----|-----------------------|----------------------|----|





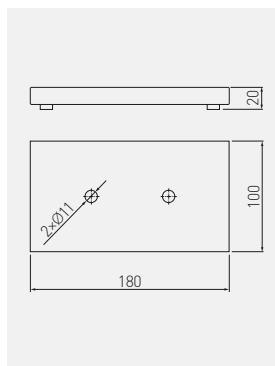

Nóžka MDN-926  
 Leg MDN-926  
 Ножка MDN-926

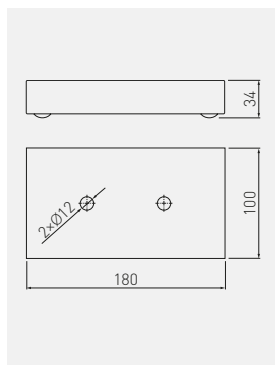

|   |   |   |   |   |
|---|---|---|---|---|
|  |  H<br>mm |  |  |  |
| NM-MDN926-01  | 20  | chrom / chrome / хром   | stal / steel / сталь  | 50  |

Nóžka MDN-927  
 Leg MDN-927  
 Ножка MDN-927



|   |   |   |   |   |
|---|---|---|---|---|
|  |  H<br>mm |  |  |  |
| NM-MDN927-01  | 34  | chrom / chrome / хром   | stal / steel / сталь  | 50  |

Nóżka MDN-941  
 Leg MDN-941  
 Ножка MDN-941

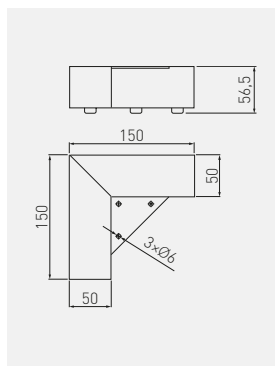

|              |       |                       |                      |    |
|--------------|-------|-----------------------|----------------------|----|
|              |       |                       |                      |    |
| NM-MDN941-01 | 56 mm | chrom / chrome / хром | stal / steel / сталь | 25 |

Ślizgacz WPJ z regulacją  
 Adjustable furniture slider WPJ  
 Опора WPJ с регулировкой

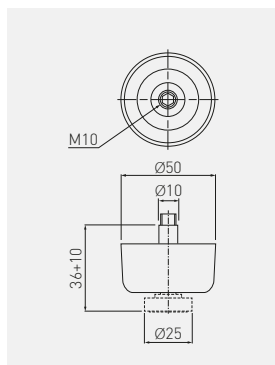

|              |            |                         |                                 |   |
|--------------|------------|-------------------------|---------------------------------|---|
|              |            |                         |                                 |   |
| NM-WPJ22-D20 | 36 + 10 mm | czarny / black / чёрный | tworzywo / plastic / пластмасса | 5 |

Ślizgacz SLZ pojedynczy  
Furniture slider SLZ single  
Подпятник SZL одинарный с шипом

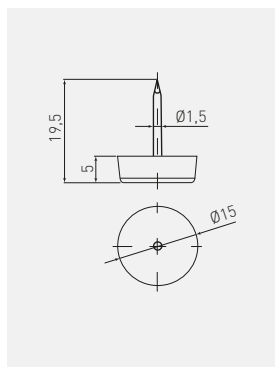

BP-SLZIGW-10

czarny / black / чёрный

tworzywo / plastic / пластмасса

Ślizgacz SLZ podwójny  
Furniture slider SLZ double  
Подпятник SZL вдвойнный с шипами

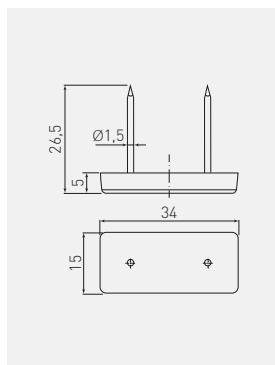

BP-SLZIGW-21

czarny  
black  
чёрный

tworzywo  
plastic  
пластмасса

250



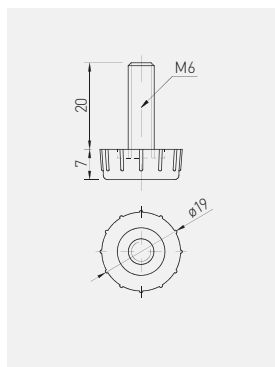

Stopka M6 regulowana  
Foot M6 adjustable  
Подпятник M6 с регулировкой

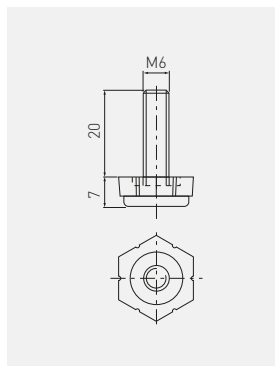

|   |   |   |
|---|---|---|
|  |  |  |
| NM-STOPKA-M6  | ocynk<br>galvanized<br>гальваника   | stal, tworzywo<br>steel, plastic<br>сталь, пластмасса                             |

Stopka M6 regulowana sześciokątna  
Foot M6 adjustable hexagonal  
Подпятник M6 с регулировкой (шестигранная)



|   |   |   |   |
|---|---|---|---|
|  |  |  |  |
| NM-STOPKSZESTK-M6   | ocynk<br>galvanized<br>гальваника   | stal, tworzywo<br>steel, plastic<br>сталь, пластмасса                               | 250   |

Mufa M6  
Socket M6  
Муфта M6



NM-MUFAWB-00



NM-MUFAWK-00

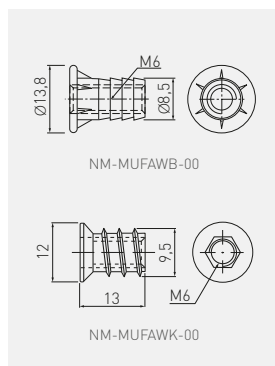

|              |  |                                 |      |      |
|--------------|--|---------------------------------|------|------|
|              |  |                                 |      |      |
| NM-MUFAWB-00 | wbijana<br>screw-in sleeve<br>врезная  | srebrny<br>silver<br>серебряный | ZnAl | 2500 |
| NM-MUFAWK-00 | wkręcana<br>screwed<br>для вкручивания |                                 |      | 4000 |

Nóżka DPD z regulacją  
Adjustable leg DPD  
Опора DPD с регулировкой

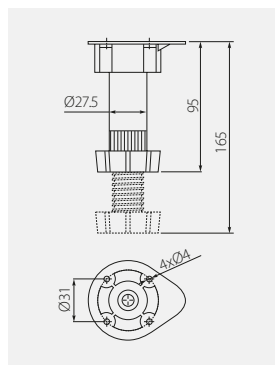

|              |                |          |                         |                                 |     |
|--------------|----------------|----------|-------------------------|---------------------------------|-----|
|              |                |          |                         |                                 |     |
| NM-DPD20-100 | 95 - 165<br>mm | 60<br>kg | czarny / black / чёрный | tworzywo / plastic / пластмасса | 200 |

Klip do nóżki DPD  
Plinth clip DPD  
Клипса к опоре DPD

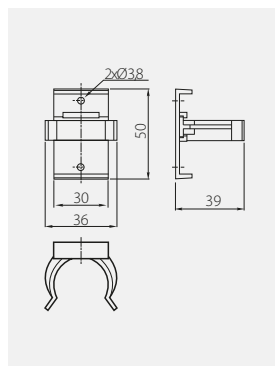

|              |                         |                                 |      |
|--------------|-------------------------|---------------------------------|------|
| NM-KL-DPL-20 | czarny / black / чёрный | tworzywo / plastic / пластмасса | 1500 |
|--------------|-------------------------|---------------------------------|------|

Nóżka DPA  
Leg DPA  
Опора DPA

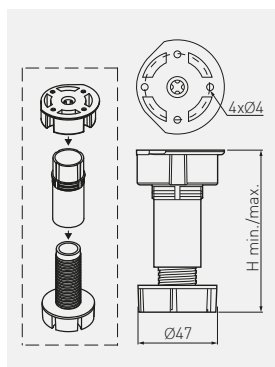

|               |  |           |     |                           |                                   |     |
|---------------|--|-----------|-----|---------------------------|-----------------------------------|-----|
| NM-DPA20-100  | pakowane w karton<br>packing in box<br>картонная упаковка          | 87 - 120  | 100 | czarny<br>black<br>чёрный | tworzywo<br>plastic<br>пластмасса | 250 |
| NM-DPA20-150  |  | 137 - 170 |     |                           |                                   | 200 |
| NM-DPA20-100W | pakowane w worek<br>packing in plastic bag<br>полиэтиленовый пакет | 87 - 120  |     |                           |                                   | 100 |
| NM-DPA20-150W |  | 137 - 170 |     |                           |                                   | 400 |

Klip do nóżki DPA  
Plinth clip DPA  
Клипса к опоре DPA

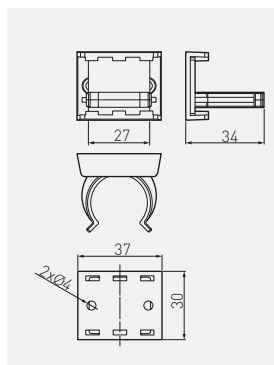

NM-KL-DPA-20



czarny / black / чёрный



tworzywo / plastic / пластмасса

Nóżka MLA-50 z regulacją  
Adjustable leg MLA-50  
Опора MLA-50 с регулировкой

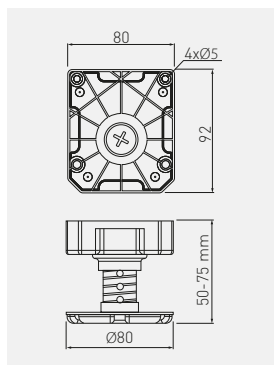

NM-MLA-50-75



50-75



450



czarny / black / чёрный









tworzywo / plastic / пластмасса

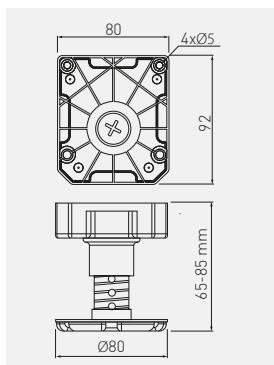

50





Nóżka MLA-65 z regulacją  
Adjustable leg MLA-65  
Опора MLA-65 с регулировкой

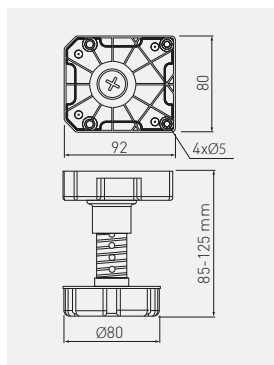

|   |   |  |   |   |   |
|---|---|--|---|---|---|
|  |  H<br>mm |  kg |  |  |  |
| NM-MLA-65-85  | 65 - 85   | 450  | czarny / black / чёрный   | tworzywo / plastic / пластмасса   | 50  |

Nóżka MLA-85 z regulacją  
Adjustable leg MLA-85  
Опора MLA-85 с регулировкой







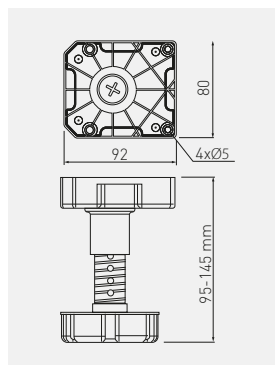

|   |   |  |   |   |   |
|---|---|--|---|---|---|
|  |  H<br>mm |  kg |  |  |  |
| NM-MLA-85-125   | 85 - 125  | 450  | czarny / black / чёрный   | tworzywo / plastic / пластмасса   | 50  |







Nóżka MLA-95 z regulacją  
Adjustable leg MLA-95  
Опора MLA-95 с регулировкой

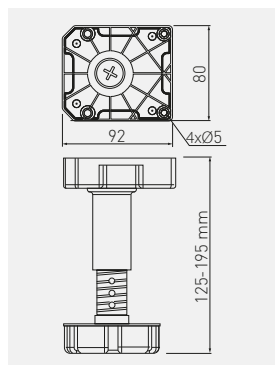

|   |   |  |   |   |   |
|---|---|--|---|---|---|
|  |  H<br>mm |  kg |  |  |  |
| NM-MLA-95-145   | 95 - 145  | 450  | czarny / black / чёрный   | tworzywo / plastic / пластмасса   | 100   |

Nóżka MLA-125 z regulacją  
Adjustable leg MLA-125  
Опора MLA-125 с регулировкой



|   |   |  |   |   |   |
|---|---|--|---|---|---|
|  |  H<br>mm |  kg |  |  |  |
| NM-MLA-125-195  | 125 - 195   | 450  | czarny / black / чёрный   | tworzywo / plastic / пластмасса   | 50  |

Klip do nóżek MLA  
 Clip for MLA legs  
 Клипса к опоре MLA

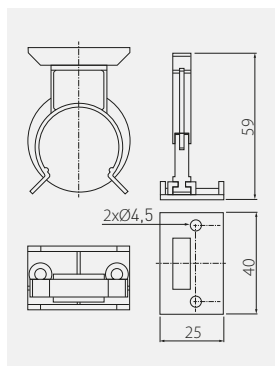

NM-MLA-KL

czarny / black / чёрный

tworzywo / plastic / пластмасса

100



Noga A6 z regulacją  
Adjustable leg A6  
Опора A6 с регулировкой

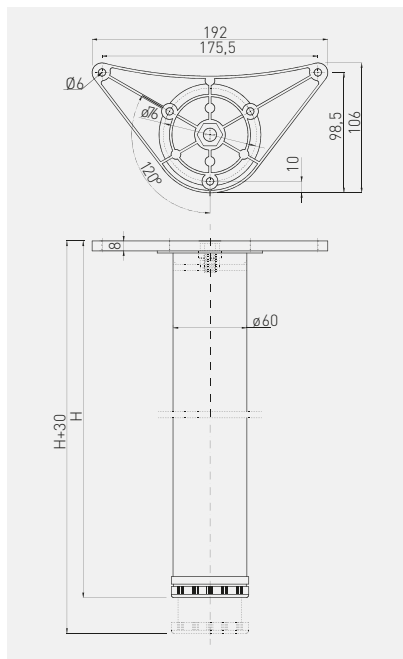

|                |   |   |  |   |   |
|----------------|---|---|--|---|---|
| NM-A60710-01   | 710 + 30  | chrom / chrome / хром                                 | stal, ZnA,<br>steel, ZnAl<br>сталь, ZnAl | 4 |   |
| NM-A60710-02   |   | satyna / satin / сатин                                |  |   |   |
| NM-A60710-05   |   | aluminium / aluminium / алюминий                      |  |   |   |
| NM-A60710-06*  |   | stal szczotkowana / brushed steel / шлифованная сталь |  |   |   |
| NM-A60710-10N* |   | biały / white / белый                                 |  |   |   |
| NM-A60710-20   |   | czarny / black / чёрный                               |  |   |   |
| NM-A60710-80N  | srebrny / silver / серебристый                        | stal, ZnA,<br>steel, ZnAl<br>сталь, ZnAl              |  |   | 4 |
| NM-A60820-01   | chrom / chrome / хром                                 |   |  |   |   |
| NM-A60820-02   | satyna / satin / сатин                                |   |  |   |   |
| NM-A60820-05   | aluminium / aluminium / алюминий                      |   |  |   |   |
| NM-A60820-06*  | stal szczotkowana / brushed steel / шлифованная сталь |   |  |   |   |
| NM-A60820-10N* | biały / white / белый                                 |   |  |   |   |
| NM-A60820-20*  | czarny / black / чёрный                               |   |  |   |   |
| NM-A60820-80N* | srebrny / silver / серебристый                        |   |  |   |   |
| NM-A60870-01*  | chrom / chrome / хром                                 |   |  |   |   |
| NM-A60870-02*  | satyna / satin / сатин                                |   |  |   |   |
| NM-A60870-05*  | aluminium / aluminium / алюминий                      |   |  |   |   |
| NM-A60870-06*  | stal szczotkowana / brushed steel / шлифованная сталь |   |  |   |   |
| NM-A60870-10N* | biały / white / белый                                 |   |  |   |   |
| NM-A60870-20*  | czarny / black / чёрный                               |   |  |   |   |
| NM-A60870-80N* | srebrny / silver / серебристый                        |   |  |   |   |
| NM-A61100-01   | chrom / chrome / хром                                 | stal, ZnA,<br>steel, ZnAl<br>сталь, ZnAl              |  |   | 4 |
| NM-A61100-02   | satyna / satin / сатин                                |   |  |   |   |
| NM-A61100-05   | aluminium / aluminium / алюминий                      |   |  |   |   |
| NM-A61100-06   | stal szczotkowana / brushed steel / шлифованная сталь |   |  |   |   |
| NM-A61100-10N* | biały / white / белый                                 |   |  |   |   |
| NM-A61100-20*  | czarny / black / чёрный                               |   |  |   |   |

\* Dostępny na zamówienie / Available only for individual order / Доступен под заказ

Noga NM-A80 z regulacją  
Adjustable leg NM-A80  
Опора NM-A80 с регулировкой

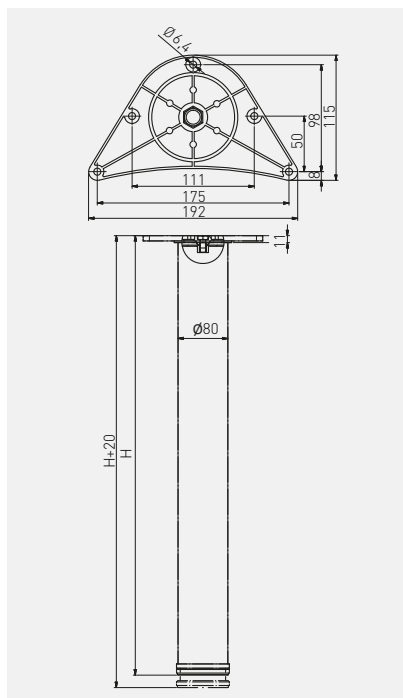

|               |          |   |  |   |
|---------------|----------|---|--|---|
| NM-A80710-01* | 710 + 20 | chrom / chrome / хром                                 | ZnAl, stal<br>ZnAl, steel<br>ZnAl, сталь | 2 |
| NM-A80710-02* |          | satyna / satin / сатин                                |  |   |
| NM-A80710-03* |          | złoty / gold / золото                                 |  |   |
| NM-A80710-05* |          | aluminium / aluminium / алюминий                      |  |   |
| NM-A80710-06* |          | stal szczotkowana / brushed steel / шлифованная сталь |  |   |
| NM-A80710-10* |          | biały / white / белый                                 |  |   |
| NM-A80710-20* |          | czarny / black / чёрный                               |  |   |
| NM-A80710-80* |          | srebrny / silver / серебристый                        |  |   |
| NM-A80870-01* | 870 + 20 | chrom / chrome / хром                                 | ZnAl, stal<br>ZnAl, steel<br>ZnAl, сталь | 2 |
| NM-A80870-02* |          | satyna / satin / сатин                                |  |   |
| NM-A80870-03* |          | złoty / gold / золото                                 |  |   |
| NM-A80870-05* |          | aluminium / aluminium / алюминий                      |  |   |
| NM-A80870-06* |          | stal szczotkowana / brushed steel / шлифованная сталь |  |   |
| NM-A80870-10* |          | biały / white / белый                                 |  |   |
| NM-A80870-20* |          | czarny / black / чёрный                               |  |   |
| NM-A80870-80* |          | srebrny / silver / серебристый                        |  |   |

\* Dostępny na zamówienie / Available only for individual order / Доступен под заказ

Noga G6 z regulacją  
Adjustable leg G6  
Опора G6 с регулировкой

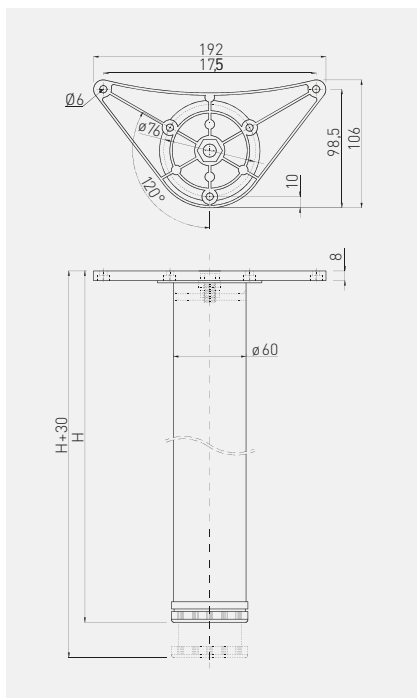



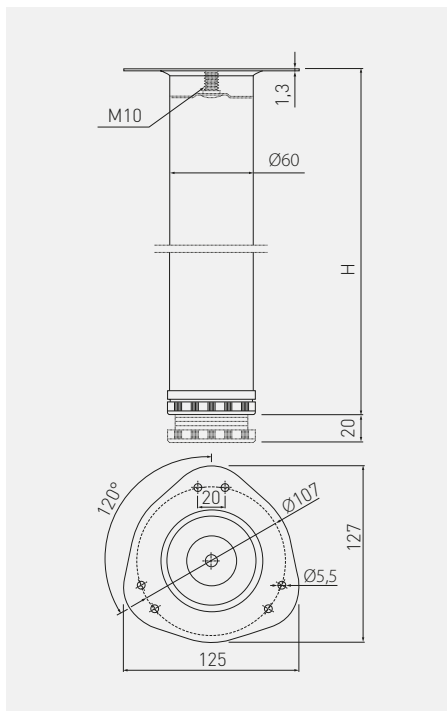

|                |  |  H<br>mm |  |  |  |  |   |  |   |
|----------------|--|--|--|--|--|--|---|--|---|
| NM-G60710-01N  |  | 710 + 30   | chrom / chrome / хром  |  |  |  |   |  |   |
| NM-G60710-02N  |  |  | satyna / satin / сатин   |  |  |  |   |  |   |
| NM-G60710-05N  |  |  | aluminium / aluminium / алюминий   |  |  |  |   |  |   |
| NM-G60710-06N  |  |  | stal szczotkowana / brushed steel / шлифованная сталь                              |  |  |  |   |  |   |
| NM-G60710-10N* |  |  | biały / white / белый  |  |  |  |   |  |   |
| NM-G60710-20N  |  |  | czarny / black / чёрный  |  |  |  |   |  |   |
| NM-G60710-80N  |  |  | srebrny/ silver/ серебристый   |  |  |  |   |  |   |
| NM-G60820-01N  |  | 820 + 30   | chrom / chrome / хром  |  |  | ZnAl, stal<br>ZnAl, steel<br>ZnAl, сталь | 4 |  |   |
| NM-G60820-05N  |  |  | aluminium / aluminium / алюминий   |  |  |  |   |  |   |
| NM-G60820-06N  |  |  | stal szczotkowana / brushed steel / шлифованная сталь                              |  |  |  |   |  |   |
| NM-G60820-10N* |  |  | biały / white / белый  |  |  |  |   |  |   |
| NM-G60820-20N  |  |  | czarny / black / чёрный  |  |  |  |   |  |   |
| NM-G61100-01N  |  | 1100 + 30  | chrom / chrome / хром  |  |  |  |   | ZnAl, stal<br>ZnAl, steel<br>ZnAl, сталь | 4 |
| NM-G61100-20N  |  |  | czarny / black / чёрный  |  |  |  |   |  |   |

\* Na zamówienie dostępna w kolorze białym / For special orders available in white color / Под заказ доступна в белом цвете

Noga S6 z regulacją  
Adjustable leg S6  
Опора S6 с регулировкой



|                |  |  H<br>mm |  |  |  |
|----------------|---|---|---|---|---|
| NM-S60710-01A  | 710 + 20  | 710 + 20  | chrom / chrome / хром   | stal<br>steel<br>сталь  | 4   |
| NM-S60710-02A  |   |   | satyna / satin / сатин  |   |   |
| NM-S60710-05A  |   |   | aluminium / aluminium / алюминий  |   |   |
| NM-S60710-06A  |   |   | stal szczotkowana / brushed steel / шлифованная сталь                               |   |   |
| NM-S60710-10A* |   |   | biały / white / белый   |   |   |
| NM-S60710-20A  |   |   | czarny / black / чёрный   |   |   |
| NM-S60820-01A  | 820 + 20  | 820 + 20  | chrom / chrome / хром   |   |   |
| NM-S60820-02A* |   |   | satyna / satin / сатин  |   |   |
| NM-S60820-05A  |   |   | aluminium / aluminium / алюминий  |   |   |
| NM-S60820-06A* |   |   | stal szczotkowana / brushed steel / шлифованная сталь                               |   |   |
| NM-S60820-10A* |   |   | biały / white / белый   |   |   |
| NM-S60820-20A* |   |   | czarny / black / чёрный   |   |   |

\* Dostępny na zamówienie / Available only for individual order / Доступен под заказ

Noga F-50 składana  
 Leg F-50 foldable  
 Складная опора F-50

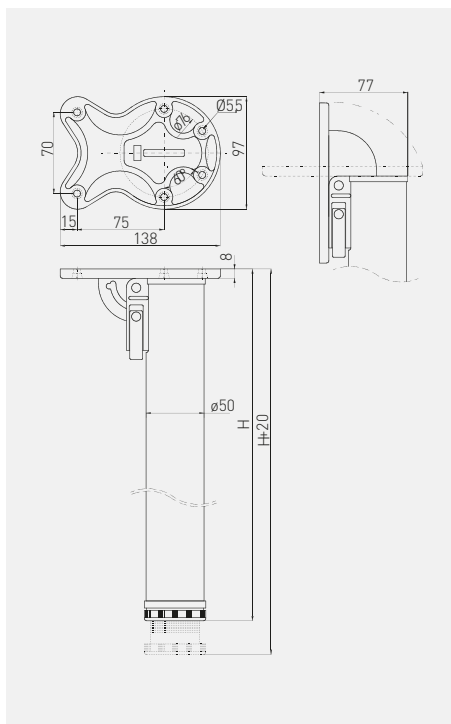



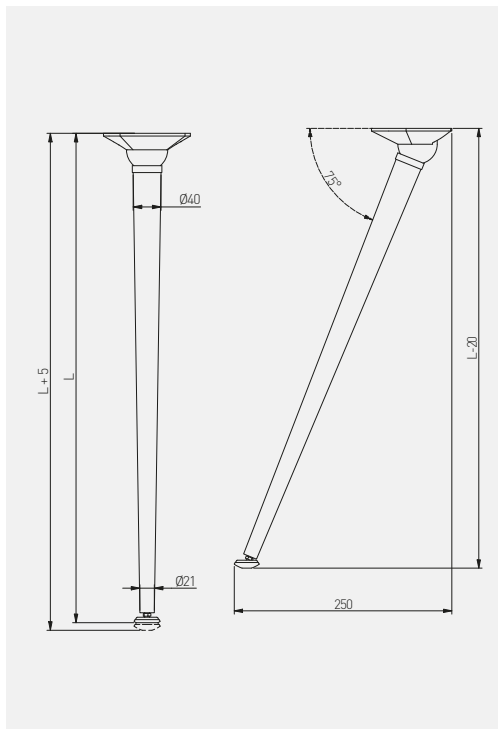

|               |  |  H<br>mm |  |  |  |
|---------------|---|---|---|---|---|
| NM-F50710-01  |   | 710 + 20  | chrom / chrome / хром   |  | 8   |
| NM-F50710-06  | stal szczotkowana / brushed steel / шлифованная сталь                               |   |   |   |   |
| NM-F50710-10  | biały / white / белый   |   |   |   |   |
| NM-F50710-20  | czarny / black / чёрный   |   |   |   |   |
| NM-F50870-01  |   | 870 + 20  | chrom / chrome / хром   |   |   |
| NM-F50870-06  | stal szczotkowana / brushed steel / шлифованная сталь                               |   |   |   |   |
| NM-F50870-10* | biały / white / белый   |   |   |   |   |
| NM-F50870-20  | czarny / black / чёрный   |   |   |   |   |

\* Dostępny na zamówienie / Available only for individual order / Доступен под заказ

Noga X-LINE skośna  
X-LINE oblique leg  
X-LINE косая опора









|                   |  H<br>mm |  |  |  |
|-------------------|---|---|---|---|
| NM-X-LINE40710-01 | 710   | chrom / chrome / хром   | stal, tworzywo<br>steel, plastic<br>сталь, пластмасса                               | 4   |
| NM-X-LINE40710-20 |   | czarny / black / чёрный   |   |   |
| NM-X-LINE40710-10 |   | biały / white / белый   |   |   |

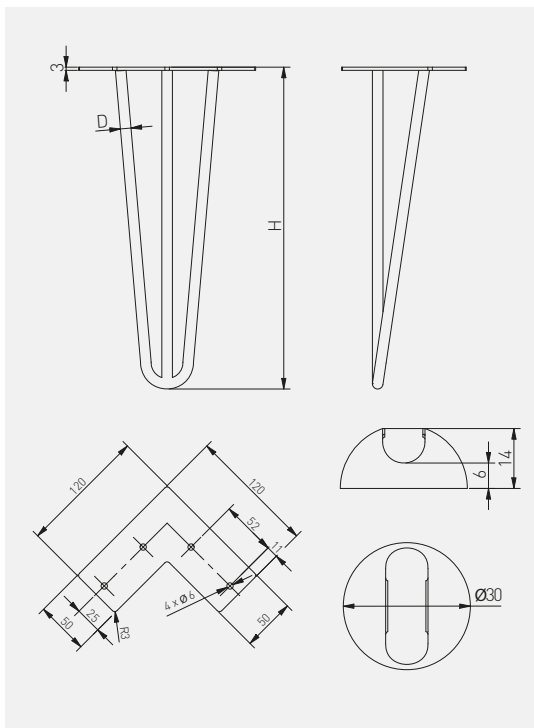



Noga ARTO – HAIRPIN  
 ARTO leg – HAIRPIN  
 ARTO нога – HAIRPIN







|  |  H<br>mm |  ØD<br>(mm) |  |  |  |
|---|---|--|---|---|---|
| NM-ARTO-10-3R304-20M  | 304   | Ø10  | czarny matt<br>black matt<br>чёрный матовый   | stal, tworzywo<br>steel, plastic<br>сталь, пластмасса                               | 4   |
| NM-ARTO-10-3R406-20M  | 406   |  |   |   |   |
| NM-ARTO-10-3R711-20M  | 711   |  |   |   |   |
| NM-ARTO-12-3R304-20M  | 304   | Ø12  |   |   |   |
| NM-ARTO-12-3R406-20M  | 406   |  |   |   |   |
| NM-ARTO-12-3R711-20M  | 711   |  |   |   |   |

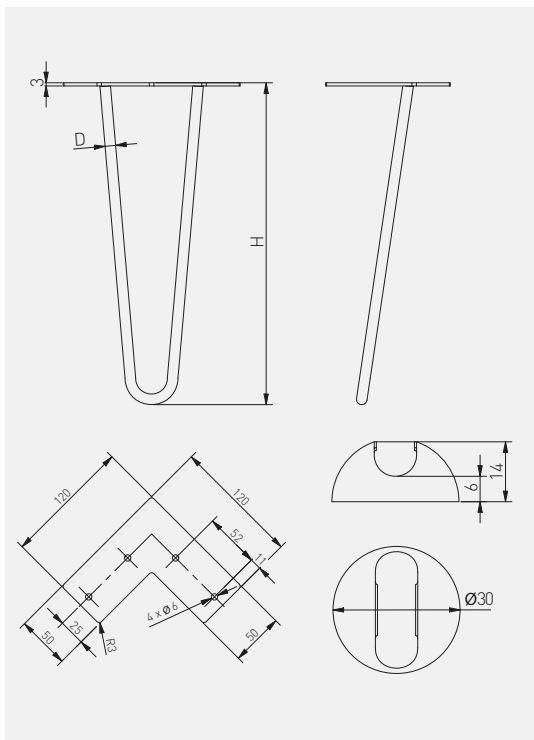

Noga ARTO – HAIRPIN  
 ARTO leg – HAIRPIN  
 ARTO нога – HAIRPIN



|  |  H<br>mm | $\varnothing D$<br>(mm) |  |  |  |
|---|---|-------------------------|---|---|---|
| NM-ARTO-10-2R304-20M  | 304   | ø10                     | czarny mat<br>black matt<br>чёрный матовый  | stal, tworzywo<br>steel, plastic<br>сталь, пластмасса                               | 4   |
| NM-ARTO-10-2R406-20M  | 406   |                         |   |   |   |
| NM-ARTO-10-2R711-20M  | 711   |                         |   |   |   |
| NM-ARTO-12-2R304-20M  | 304   | ø12                     |   |   |   |
| NM-ARTO-12-2R406-20M  | 406   |                         |   |   |   |
| NM-ARTO-12-2R711-20M  | 711   |                         |   |   |   |

Noga kwadratowa z regulacją  
 Square furniture leg  
 Квадратная опора с регулировкой

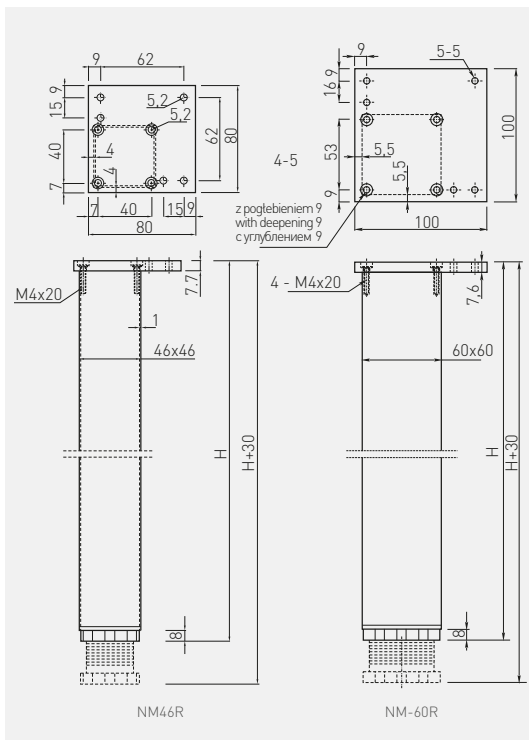
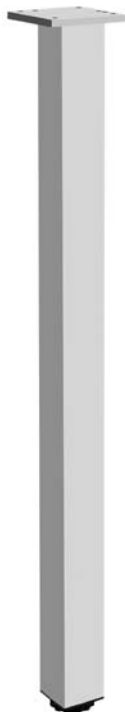

|              |  |  H<br>mm |  |  |  |
|--------------|---|---|---|---|---|
| NM-46R710-05 |   | 710 + 30  | aluminium / aluminium / алюминий  | aluminium<br>aluminium<br>алюминий  | 4   |
| NM-46R820-05 |   | 820 + 30  |   |   |   |
| NM-60R710-05 |   | 710 + 30  |   |   |   |
| NM-60R820-05 |   | 820 + 30  |   |   |   |
| NM-60R710-06 |   | 710 + 30  | stal szczotkowana / brushed steel / шлифованная сталь                               |   |   |
| NM-60R710-20 |   |   | czarny / black / чёрный   |   |   |

Noga stelażowa INDUSTRIA  
 Industria frame  
 Опора для столешницы Industria

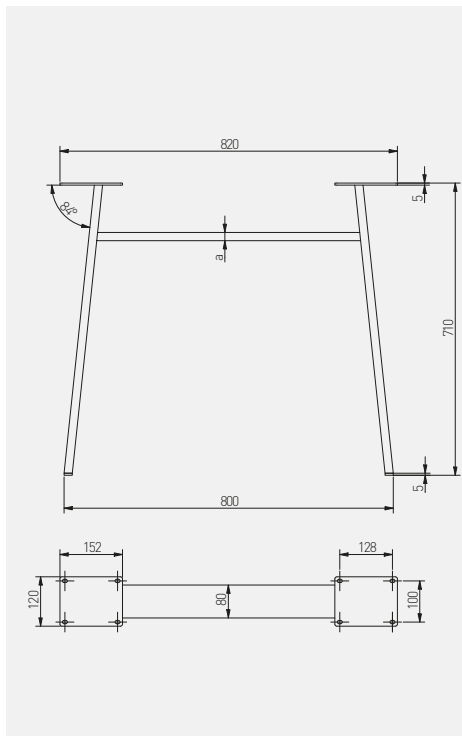

|  |  | <b>a</b><br>(mm) |  |  |
|---|---|------------------|---|---|
| NM-INDUSTRIA-H20-710X820-20M*   | czarny mat / black matt / чёрный матовый  | 20               | stal<br>steel<br>сталь  | 1   |
| NM-INDUSTRIA-H40-710X820-20M*   |   | 40               |   |   |





\*Dostępny na zamówienie indywidualne / Available only for individual order / Доступен под заказ



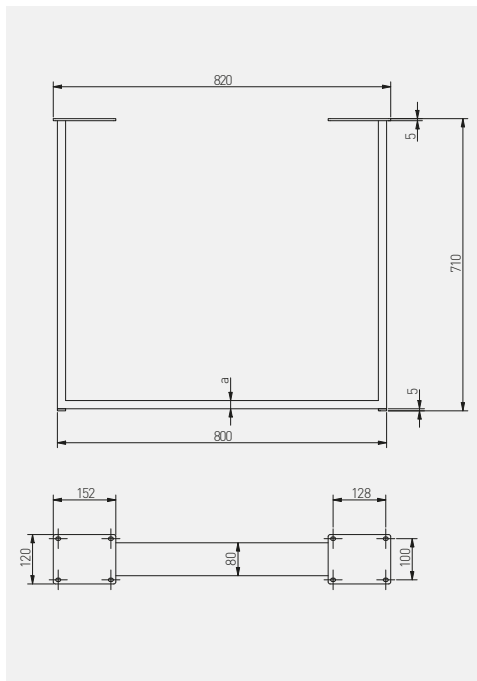

Noga stelażowa INDUSTRIA  
 Industria frame  
 Опора для столешницы Industria



|  |  | <b>a</b><br>(mm) |  |  |
|---|---|------------------|---|---|
| NM-INDUSTRIA-P20-710X820-20M*   | czarny mat / black matt / чёрный матовый  | 20               | stal<br>steel<br>сталь  | 1   |
| NM-INDUSTRIA-P40-710X820-20M*   |   | 40               |   |   |
| NM-INDUSTRIA-P80-710X820-20M*   |   | 80               |   |   |

\*Dostępny na zamówienie indywidualne / Available only for individual order / Доступен под заказ



Noga stelażowa INDUSTRIA  
 Industria frame  
 Опора для столешницы Industria

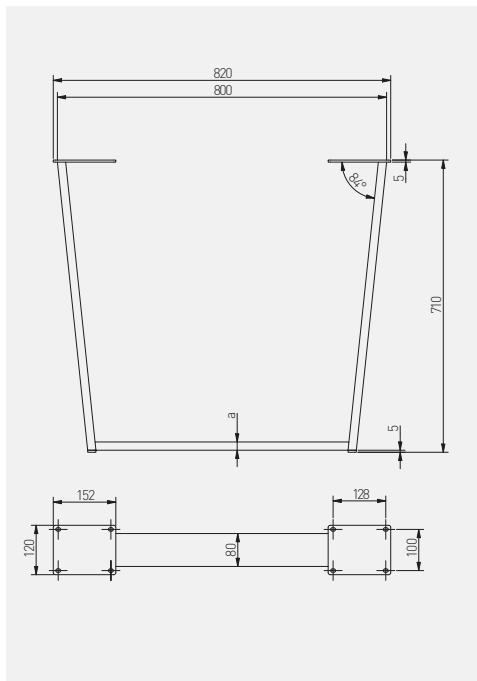

|                               |  | a<br>(mm) |                        |   |
|-------------------------------|--|-----------|------------------------|---|
| NM-INDUSTRIA-T20-710X820-20M* | czarny mat / black matt / чёрный матовый | 20        | stal<br>steel<br>сталь | 1 |
| NM-INDUSTRIA-T40-710X820-20M* |  | 40        |                        |   |

\*Dostępny na zamówienie indywidualne / Available only for individual order / Доступен под заказ

Noga stelażowa INDUSTRIA  
 Industria frame  
 Опора для столешницы Industria

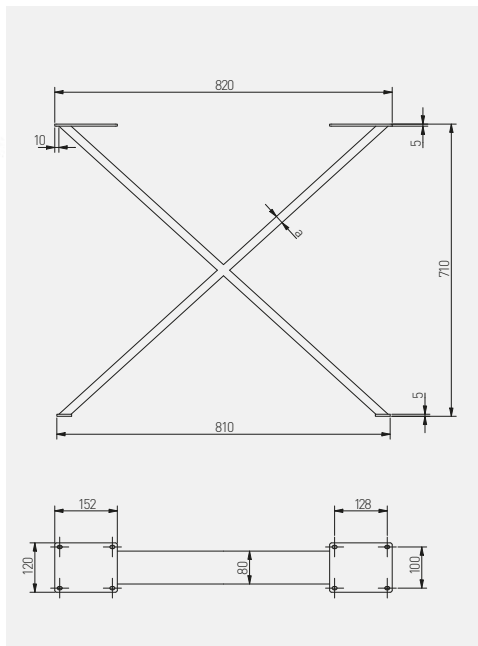

|                               |  | a<br>(mm) |                        |   |
|-------------------------------|--|-----------|------------------------|---|
| NM-INDUSTRIA-X20-710X820-20M* | czarny mat / black matt / чёрный матовый | 20        | stal<br>steel<br>сталь | 1 |
| NM-INDUSTRIA-X40-710X820-20M* |  | 40        |                        |   |
| NM-INDUSTRIA-X80-710X820-20M* |  | 80        |                        |   |

\*Dostępny na zamówienie indywidualne / Available only for individual order / Доступен под заказ

Stelaż biurkowy  
Metal frames for desk  
Металлический каркас для стола

NEW

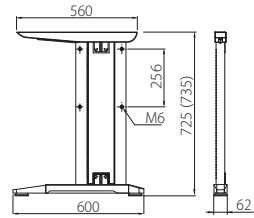

Otwory do montażu blatu Ø7  
Table top mounting holes Ø7  
Отверстия для монтажа столешницы Ø7







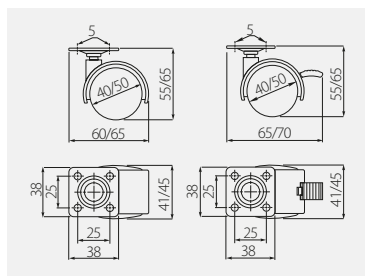

|               |           |  |                      |   |
|---------------|-----------|--|----------------------|---|
| SB-A60X72-80  | 725 (735) | srebrny / silver / серебристый           | stal / steel / сталь | 1 |
| SB-A60x72-20M |           | czarny mat / black matt / чёрный матовый |                      | 1 |









Rolka KM-D20  
 Furniture caster KM-D20  
 Колесная опора KM-D20

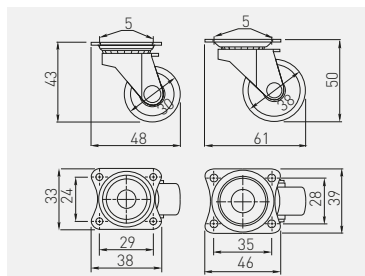

|  |  | <br>mm | <br>kg |  |  |
|---|---|---|---|---|---|
| KM-00-40-D20  | bez hamulca<br>without break  | 40  | 18  | czarny<br>black<br>чёрный   | stal + tworzywo<br>steel + plastic<br>сталь + пластмасса                          |
| KM-00-50-D20  | без стопора   | 50  | 22  |   |   |
| KM-0H-40-D20  | z hamulcem<br>with break  | 40  | 18  | czarny<br>black<br>чёрный   | stal + tworzywo<br>steel + plastic<br>сталь + пластмасса                          |
| KM-0H-50-D20  | со стопором   | 50  | 22  |   |   |



Rolka KM 15 plastikowa  
 Furniture caster KM 15 plastic  
 Колесная опора пластиковая KM 15



|  | <br>mm | <br>kg |  |  |
|---|---|---|---|---|
| KM-015030-10  | 30  | 13,5  | biały / white / белый   | stal + tworzywo<br>steel + plastic<br>сталь + пластмасса                            |
| KM-015030-20  | 30  |   | czarny / black / чёрный   |   |
| KM-015038-10  | 38  | 16  | biały / white / белый   |   |

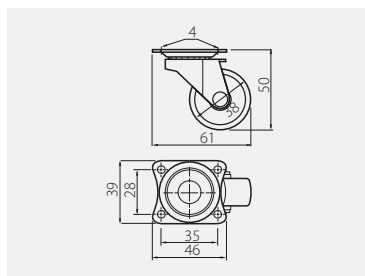





Rolka KM 15 gumowa  
 Rubber furniture caster KM 15  
 Колесная опора резиновая KM 15

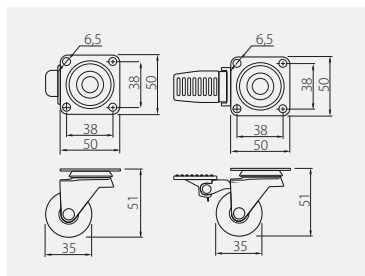

|   |  |  |   |   |
|---|--|--|---|---|
|  |  mm |  kg |  |  |
| KM-015038-GM  | 38   | 16   | czarny / black / чёрный   | stal + guma<br>steel + rubber<br>сталь + резина                                   |





Rolka KMA 35  
 Furniture caster KMA 35  
 Колесная опора KMA 35

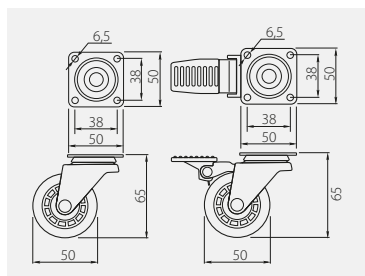

|   |   |  |  |   |   |
|---|---|--|--|---|---|
|  |  |  mm |  kg |  |  |
| KM-A035MM-00  | bez hamulca<br>without break<br>без стопора   | 35   | 25   | przeźroczysty / transparent / прозрачный  | PC / PU   |
| KM-A035MM-30  |   |  |  | brązowy / brown / коричневый  |   |
| KM-AH35MM-00  | z hamulcem<br>with break<br>со стопором   |  |  | przeźroczysty / transparent / прозрачный  |   |
| KM-AH35MM-30  |   |  |  | brązowy / brown / коричневый  |   |





Rolka KMA 50  
Furniture caster KMA 50  
Колесная опора KMA 50

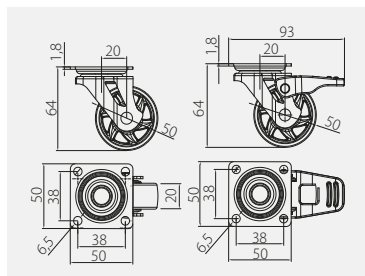

|              |  |  mm |  kg |  |  |
|--------------|---|--|--|---|---|
| KM-A050MM-00 | bez hamulca<br>without break<br>без стопора                                       | 50   | 35   | przeźroczysty / transparent / прозрачный  | PC / PU   |
| KM-A050MM-30 |   |  |  | brąz / brown / коричневый   |   |
| KM-AH50MM-00 | z hamulcem<br>with break<br>со стопором   |  |  | przeźroczysty / transparent / прозрачный  |   |
| KM-AH50MM-30 |   |  |  | brąz / brown / коричневый   |   |





Rolka SHIFT 50  
Furniture caster SHIFT 50  
Колесная опора SHIFT 50

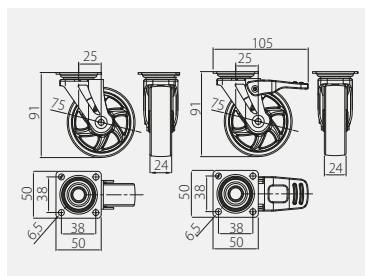

|              |  |  mm |  kg |  |  |
|--------------|---|--|--|---|---|
| KM-B050MM-00 | bez hamulca<br>without break<br>без стопора   | 50   | 30   | przeźroczysty / transparent / прозрачный  | PC / PU   |
| KM-B050MM-30 |   |  |  | brąz / brown / коричневый   |   |
| KM-BH50MM-00 | z hamulcem<br>with break<br>со стопором   |  |  | przeźroczysty / transparent / прозрачный  |   |
| KM-BH50MM-30 |   |  |  | brąz / brown / коричневый   |   |





Rolka SHIFT 75  
Furniture caster SHIFT 75  
Колесная опора SHIFT 75

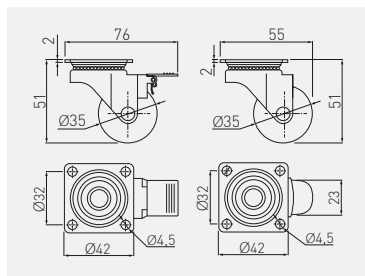

|              |  |  |  |  |  |
|--------------|---|---|---|---|---|
| KM-B075MM-00 | bez hamulca<br>without break<br>без стопора                                       | 75  | 40  | przeźroczysty / transparent / прозрачный  | PC / PU   |
| KM-B075MM-30 |   |   |   | brąz / brown / коричневый   |   |
| KM-BH75MM-00 | z hamulcem<br>with break<br>со стопором   |   |   | przeźroczysty / transparent / прозрачный  |   |
| KM-BH75MM-30 |   |   |   | brąz / brown / коричневый   |   |





Rolka BRAZYLIA 35  
Furniture caster BRAZYLIA 35  
Колесная опора BRAZYLIA 35

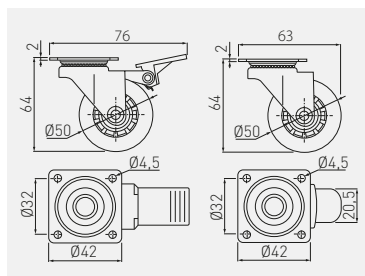

|                |  |  |  |  |  |
|----------------|---|---|---|---|---|
| KM-RD-35-SF    | bez hamulca<br>without break<br>без стопора   | 35  | 30  | przeźroczysty / transparent / прозрачный  | PC, PU  |
| KM-RD-35-SF-20 |   |   |   | czarny / black / чёрный   |   |
| KM-RD-35-CF    | z hamulcem<br>with break<br>со стопором   |   |   | przeźroczysty / transparent / прозрачный  |   |
| KM-RD-35-CF-20 |   |   |   | czarny / black / чёрный   |   |





Rolka BRAZYLIA 50  
 Furniture caster BRAZYLIA 50  
 Колесная опора BRAZYLIA 50

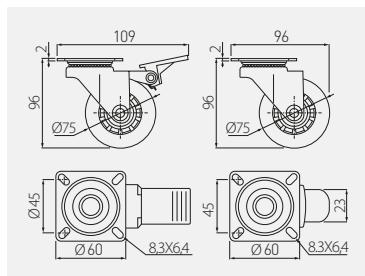

|                |  |  |  |  |  |
|----------------|---|---|---|---|---|
| KM-RD-50-SF    | bez hamulca<br>without break  | 50  | 40  | przeźroczysty / transparent / прозрачный  | PC, PU  |
| KM-RD-50-SF-20 | bez stopora   |   |   | czarny / black / чёрный   |   |
| KM-RD-50-CF    | z hamulcem<br>with break  |   |   | przeźroczysty / transparent / прозрачный  |   |
| KM-RD-50-CF-20 | so stoporom   |   |   | czarny / black / чёрный   |   |

Rolka BRAZYLIA 75  
 Furniture caster BRAZYLIA 75  
 Колесная опора BRAZYLIA 75







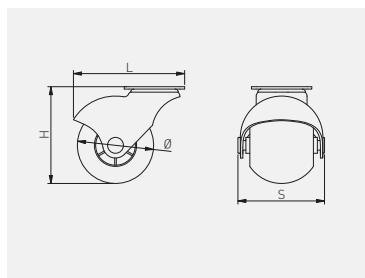

|                |  |  |  |  |  |
|----------------|---|---|---|---|---|
| KM-RD-75-SF    | bez hamulca<br>without break  | 75  | 64  | przeźroczysty / transparent / прозрачный  | PC, PU  |
| KM-RD-75-SF-20 | bez stopora   |   |   | czarny / black / чёрный   |   |
| KM-RD-75-CF    | z hamulcem<br>with break  |   |   | przeźroczysty / transparent / прозрачный  |   |
| KM-RD-75-CF-20 | so stoporom   |   |   | czarny / black / чёрный   |   |









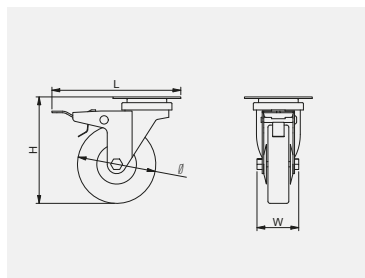

Rolka SPAIN  
Furniture Castor SPAIN  
Ролик мебельный SPAIN



|  |  mm |  mm |  kg |  |  |
|---|--|--|--|---|---|
| KM-SPAIN-40MM-18  | 40   | 53 x 62 x 47   | 15   | szary, grey, серый  | stal + guma<br>steel + rubber<br>сталь + резина                                   |
| KM-SPAIN-50MM-18  | 50   | 61 x 70 x 54   | 20   |   |   |

Rolka GREYROLL  
Castor GREYROLL  
Ролик мебельный прямоходящий GREYROLL



|  |  |  mm |  mm |  kg |  |  |
|---|---|--|--|--|---|---|
| KM-GREYROLL-50mm-BH   | bez hamulca<br>without break<br>без стопора   | 50   | 72 x 72 x 39   | 40   | szary<br>grey<br>серый  | stal + guma<br>steel + rubber<br>сталь + резина                                     |
| KM-GREYROLL-75mm-BH   |   | 75   | 98 x 104 x 42  | 55   |   |   |
| KM-GREYROLL-50mm-ZH   | z hamulcem<br>with break<br>со стопором   | 50   | 94 x 72 x 39   | 40   |   |   |
| KM-GREYROLL-75mm-ZH   |   | 75   | 117 x 104 x 42   | 55   |   |   |

**SYSTEMY PRZESUWNE  
SLIDING DOOR SYSTEMS  
РАЗДВИЖНЫЕ СИСТЕМЫ**

Dolny układ jezdny  
Bottom-running systems  
Нижняя ходовая система

486 – 516

Górny układ jezdny  
Top-running systems  
Верхняя ходовая система

517 – 521





## POZNAJ KONFIGURATOR SZAF I DRZWI PRZESUWNYCH GTV DISCOVER THE GTV CONFIGURATOR FOR WARDROBES AND SLIDING DOOR SYSTEM

## ПОЗНАКОМЬТЕСЬ С КОНФИГУРАТОРОМ ШКАФОВ И РАЗДВИЖНЫХ ДВЕРЕЙ ОТ GTV

Jeśli chcesz, żeby Twoja codzienna praca przy projektowaniu szaf była łatwiejsza, mamy świetne rozwiązanie – konfigurator szaf i drzwi przesuwnych GTV. To łatwe i intuicyjne narzędzie, które usprawni i przyspieszy pracę każdego stolarza. Z konfiguratora mogą również korzystać hurtownie meblowe, firmy oraz fabryki zajmujące się produkcją szaf. Konfigurator szaf GTV pozwala na otrzymanie dokładnego podsumowania w pliku PDF z informacjami technicznymi o szafie. Ostateczny raport ułatwia dokonanie zakupów potrzebnych materiałów.

If you want to make your daily work on designing wardrobes easier, we have got a great solution for you – the configurator for wardrobes and sliding door system from GTV. It is very intuitive and easy to use tool, which improve and accelerate the work of every carpenter. Our configurator can be also used by furniture wholesalers, companies and factories that manufacture cabinets. The GTV configurator gives you a detailed summary in a PDF file with technical information about the cabinet. With the final report from configurator it will be easier to purchase material you need.

Если вы хотите, чтобы ваша ежедневная работа над дизайном шкафов стала проще, у нас есть отличное решение - конфигурактор шкафов и раздвижных дверей от GTV. Это простой и интуитивно понятный инструмент, который улучшит и ускорит работу каждого мебельщика. К помощи конфигуратора могут прибегнуть оптовые продавцы мебели, а также фабрики, производящие шкафы-купе. Конфигуратор шкафов GTV позволяет получить точный список в файле PDF с технической информацией о гардеробной. Окончательный отчет сделает покупку необходимых материалов очень легкой.









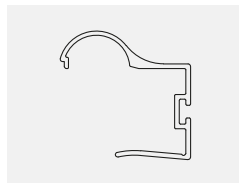

Rączka ERGO  
Handle ERGO  
Ручка ERGO



|  |  L<br>mm |  |  |
|---|---|---|---|
| A-R18ERG-270-05   | 2700  | aluminium / aluminium / алюминий  | aluminium<br>aluminium<br>алюминий  |
| A-R18ERG-270-90   |   | szampan / champagne / шампань   |   |
| A-R18ERG-270-20M  |   | czarny mat / black matt / чёрный матовый  |   |



Rączka ERGO 16  
Handle ERGO 16  
Ручка ERGO 16

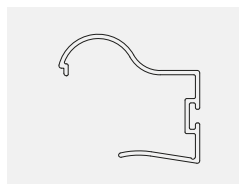

|  |  L<br>mm |  |  |
|---|---|---|---|
| A-R16ERG-220-05   | 2200  | aluminium / aluminium / алюминий  | aluminium<br>aluminium<br>алюминий  |
| A-R16ERG-230-50   | 2300  | aluminium / aluminium / алюминий  |   |
| A-R16ERG-270-50   | 2700  | aluminium / aluminium / алюминий  |   |
| A-R16ERG-270-90   | 2700  | szampan / champagne / шампань   |   |



Rączka GEO 18  
Handle GEO 18  
Ручка GEO 18

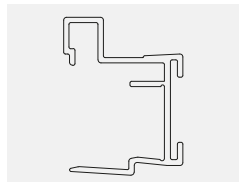





|  |  L<br>mm |  |  |
|---|---|---|---|
| A-R18GEO2-270-05  | 2700  | aluminium / aluminium / алюминий  | aluminium / aluminium / алюминий  |



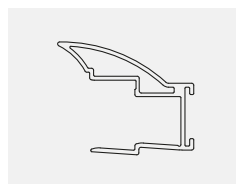





Rączka NOVO 2  
Handle NOVO 2  
Ручка NOVO 2









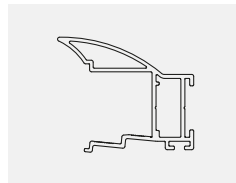



|                 |  |  L<br>mm |  |  |
|-----------------|---|---|---|---|
| A-RNOV2-270-05  |   | 2700  | aluminium / aluminium / алюминий  | aluminium<br>aluminium<br>алюминий  |
| A-RNOV2-270-10  |   |   | biały / white / белый   |   |
| A-RNOV2-270-20M |   |   | czarny mat / black matt / чёрный матовый  |   |
| A-RNOV2-270-90  |   |   | szampan / champagne / шампань   |   |

 BOARD 18 mm  
  BOARD 12 mm  
 +  
  GLASS 4 mm  
  FRAMELESS  
  × 20

Rączka NOVO S  
Handle NOVO S  
Ручка NOVO S



|                   |  |  L<br>mm |  |  |
|-------------------|---|---|---|---|
| A-R18NOVS-270-05  |   | 2700  | aluminium / aluminium / алюминий  | aluminium<br>aluminium<br>алюминий  |
| A-R18NOVS-270-10  |   |   | biały / white / белый   |   |
| A-R18NOVS-270-20M |   |   | czarny / black / чёрный   |   |
| A-R18NOVS-270-90  |   |   | szampan / champagne / шампань   |   |

 BOARD 18 mm  
  BOARD 16 mm  
  GLASS 4 mm  
  FRAME  
  FRAMELESS  
  × 24

Rączka NOVO S 19  
Handle NOVO S 19  
Ручка NOVO S 19

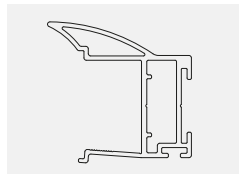



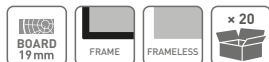

|   |   |   |   |
|---|---|---|---|
|  |  L<br>3000 |  |  |
| A-R19NOVS-300-05  | 3000  | aluminium / aluminium / алюминий  | aluminium / aluminium / алюминий  |

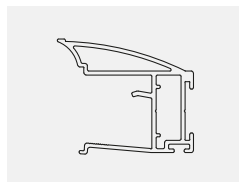

Rączka CARO  
Handle CARO  
Ручка CARO





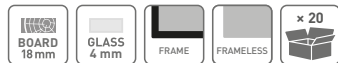

|   |   |   |   |
|---|---|---|---|
|  |  L<br>2700 |  |  |
| A-R18CARO-270-05  | 2700  | aluminium / aluminium / алюминий  | aluminium<br>aluminium<br>алюминий  |
| A-R18CARO-270-90  |   | szampan / champagne / шампань   |   |

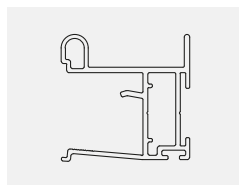

Rączka VISTA  
Handle VISTA  
Ручка VISTA



|   |   |   |   |
|---|---|---|---|
|  |  L<br>2700 |  |  |
| A-R18VIS-270-05   | 2700  | aluminium / aluminium / алюминий  | aluminium<br>aluminium<br>алюминий  |
| A-R18VIS-270-20M  |   | czarny mat / black matt / чёрный матовый  |   |
| A-R18VIS-270-90   |   | szampan / champagne / шампань   |   |

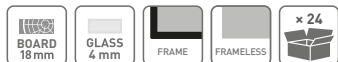



Rączka NERO  
Handle NERO  
Ручка NERO

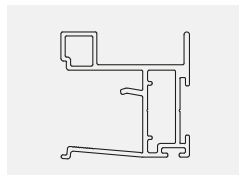

|                   |      |                                  |                                    |
|-------------------|------|----------------------------------|------------------------------------|
|                   |      |                                  |                                    |
| A-R18NERO-270-05  | 2700 | aluminium / aluminium / алюминий | aluminium<br>aluminium<br>алюминий |
| A-R18NERO-270-10  |      | biały / white / белый            |                                    |
| A-R18NERO-270-20M |      | czarny / black / чёрный          |                                    |
| A-R18NERO-270-90  |      | szampan / champagne / шампань    |                                    |

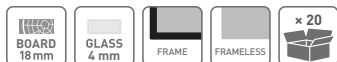

Rączka NERO 19  
Handle NERO 19  
Ручка NERO 19

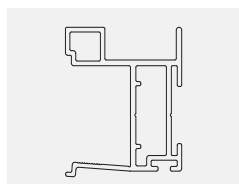

|                  |      |                                  |                                  |
|------------------|------|----------------------------------|----------------------------------|
|                  |      |                                  |                                  |
| A-R19NERO-300-05 | 3000 | aluminium / aluminium / алюминий | aluminium / aluminium / алюминий |

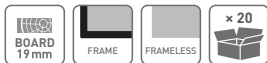

Rączka COTE  
Handle COTE  
Ручка COTE

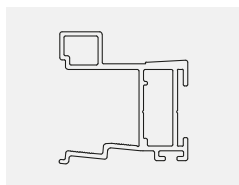

|                  |      |                                  |                                    |
|------------------|------|----------------------------------|------------------------------------|
|                  |      |                                  |                                    |
| A-R18COTE-270-05 | 2700 | aluminium / aluminium / алюминий | aluminium<br>aluminium<br>алюминий |
| A-R18COTE-270-90 |      | szampan / champagne / шампань    |                                    |



Rączka LOCA  
Handle LOCA  
Ручка LOCA

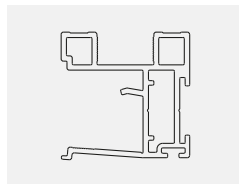

|                  |      |                                  |                                    |
|------------------|------|----------------------------------|------------------------------------|
|                  |      |                                  |                                    |
| A-R18LOCA-305-05 | 3050 | aluminium / aluminium / алюминий | aluminium<br>aluminium<br>алюминий |
| A-R18LOCA-305-90 |      | szampan / champagne / шампань    |                                    |



Rączka FLAT LINE  
Handle FLAT LINE  
Ручка FLAT LINE

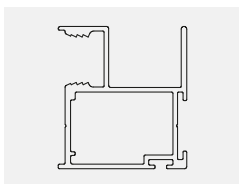

|                 |      |  |                                    |
|-----------------|------|--|------------------------------------|
|                 |      |  |                                    |
| A-R10FL-270-05  | 2700 | aluminium / aluminium / алюминий         | aluminium<br>aluminium<br>алюминий |
| A-R10FL-270-10  |      | biały / white / белый                    |                                    |
| A-R10FL-270-20M |      | czarny mat / black matt / чёрный матовый |                                    |
| A-R10FL-270-90  |      | szampan / champagne / шампань            |                                    |



Rączka MOVENA  
Handle MOVENA  
Ручка MOVENA

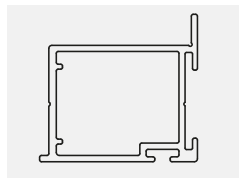

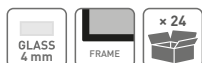

|                |      |                                  |                                    |
|----------------|------|----------------------------------|------------------------------------|
|                |      |                                  |                                    |
| A-R4MOV-270-05 | 2700 | aluminium / aluminium / алюминий | aluminium<br>aluminium<br>алюминий |

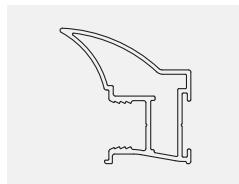

Rączka NOVO 10  
Handle NOVO 10  
Ручка NOVO 10



|  |  L<br>mm |  |  |
|---|---|---|---|
| A-R10NOV-270-05   | 2700  | aluminium / aluminium / алюминий  | aluminium<br>aluminium<br>алюминий  |
| A-R10NOV-270-10   |   | biały / white / белый   |   |
| A-R10NOV-270-20M  |   | czarny mat / black matt / чёрный матовый  |   |
| A-R10NOV-270-90   |   | szampan / champagne / шампань   |   |



Rączka FORM  
Handle FORM  
Ручка FORM

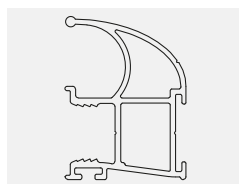





|  |  L<br>mm |  |  |
|---|---|---|---|
| A-R10FORM-270-05  | 2700  | aluminium / aluminium / алюминий  | aluminium<br>aluminium<br>алюминий  |
| A-R10FORM-270-90  |   | biały / white / белый   |   |

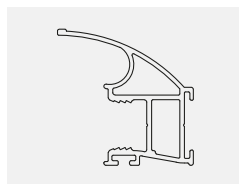

Rączka TRAF0  
Handle TRAF0  
Ручка TRAF0



|  |  L<br>mm |  |  |
|---|---|---|---|
| A-R10TRAF0-270-05   | 2700  | aluminium / aluminium / алюминий  | aluminium<br>aluminium<br>алюминий  |
| A-R10TRAF0-270-90   |   | szampan / champagne / шампань   |   |



Rączka TORO  
Handle TORO  
Ручка TORO

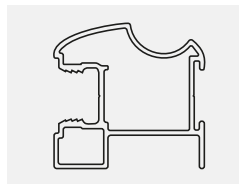
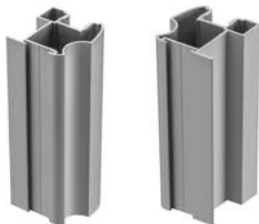



|                  |  L<br>mm |  |  |
|------------------|---|---|---|
| A-R10TORO-270-05 | 2700  | aluminium / aluminium / алюминий  | aluminium<br>aluminium<br>алюминий  |
| A-R10TORO-270-90 |   | szampan / champagne / шампань   |   |

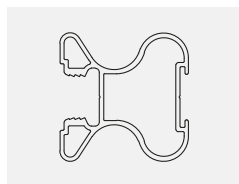

Rączka FALDA  
Handle FALDA  
Ручка FALDA





|                   |  L<br>mm |  |  |
|-------------------|---|---|---|
| A-R10FALDA-270-05 | 2700  | aluminium / aluminium / алюминий  | aluminium<br>aluminium<br>алюминий  |
| A-R10FALDA-270-90 |   | szampan / champagne / шампань   |   |

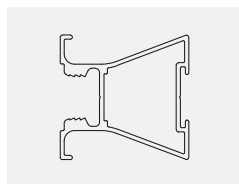

Rączka ARCO\*  
Handle ARCO\*  
Ручка ARCO\*







|                  |  L<br>mm |  |  |
|------------------|---|---|---|
| A-R10ARCO-270-05 | 2700  | aluminium / aluminium / алюминий  | aluminium<br>aluminium<br>алюминий  |
| A-R10ARCO-270-90 |   | szampan / champagne / шампань   |   |

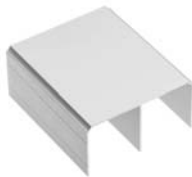

Tor górny  
Top track  
Верхняя направляющая



|  |  L<br>mm |  |  |
|---|---|---|---|
| A-TG-170-05   | 1700  | aluminium / aluminium / алюминий  | aluminium<br>aluminium<br>алюминий  |
| A-TG-170-10   |   | biały / white / белый   |   |
| A-TG-170-20M  |   | czarny / black / чёрный   |   |
| A-TG-170-90   |   | szampan / champagne / шампань   |   |
| A-TG-235-05   | 2350  | aluminium / aluminium / алюминий  |   |
| A-TG-235-10   |   | biały / white / белый   |   |
| A-TG-235-20M  |   | czarny / black / чёрный   |   |
| A-TG-235-90   |   | szampan / champagne / шампань   |   |
| A-TG-300-05   | 3000  | aluminium / aluminium / алюминий  |   |
| A-TG-300-10   |   | biały / white / белый   |   |
| A-TG-300-20M  |   | czarny / black / чёрный   |   |
| A-TG-300-90   |   | szampan / champagne / шампань   |   |
| A-TG-405-05   | 4050  | aluminium / aluminium / алюминий  |   |
| A-TG-405-10   |   | biały / white / белый   |   |
| A-TG-405-20M  |   | czarny / black / чёрный   |   |
| A-TG-405-90   |   | szampan / champagne / шампань   |   |
| A-TG-600-05   | 6000  | aluminium / aluminium / алюминий  |   |
| A-TG-600-10   |   | biały / white / белый   |   |
| A-TG-600-20M  |   | czarny / black / чёрный   |   |
| A-TG-600-90   |   | szampan / champagne / шампань   |   |



## Tor dolny EVO Bottom track EVO Нижняя направляющая EVO



|  |  L<br>mm |  |  |
|---|---|---|---|
| A-TDEVO-170-05  | 1700  | aluminium / aluminium / алюминий  | aluminium<br>aluminium<br>алюминий  |
| A-TDEVO-170-10  |   | biały / white / белый   |   |
| A-TDEVO-170-20M   |   | czarny / black / чёрный   |   |
| A-TDEVO-170-90  | szampan / champagne / шампань   |   |   |
| A-TDEVO-235-05  | 2350  | aluminium / aluminium / алюминий  |   |
| A-TDEVO-235-10  |   | biały / white / белый   |   |
| A-TDEVO-235-20M   |   | czarny / black / чёрный   |   |
| A-TDEVO-235-90  | szampan / champagne / шампань   |   |   |
| A-TDEVO-300-05  | 3000  | aluminium / aluminium / алюминий  |   |
| A-TDEVO-300-10  |   | biały / white / белый   |   |
| A-TDEVO-300-20M   |   | czarny / black / чёрный   |   |
| A-TDEVO-300-90  | szampan / champagne / шампань   |   |   |
| A-TDEVO-405-05  | 4050  | aluminium / aluminium / алюминий  |   |
| A-TDEVO-405-10  |   | biały / white / белый   |   |
| A-TDEVO-405-20M   |   | czarny / black / чёрный   |   |
| A-TDEVO-405-90  | szampan / champagne / шампань   |   |   |
| A-TDEVO-600-05  | 6000  | aluminium / aluminium / алюминий  |   |
| A-TDEVO-600-10  |   | biały / white / белый   |   |
| A-TDEVO-600-20M   |   | czarny / black / чёрный   |   |
| A-TDEVO-600-90  | szampan / champagne / шампань   |   |   |



## Maskownica EVO Masking cover EVO Декоративная накладка





|  |  L<br>mm |  |  |
|---|---|---|---|
| A-MEVO-170-05   | 1700  | aluminium / aluminium / алюминий  | aluminium<br>aluminium<br>алюминий  |
| A-MEVO-170-10A  |   | biały / white / белый   |   |
| A-MEVO-170-20M  |   | czarny / black / чёрный   |   |
| A-MEVO-170-90   | szampan / champagne / шампань   |   |   |
| A-MEVO-235-05   | 2350  | aluminium / aluminium / алюминий  |   |
| A-MEVO-235-10A  |   | biały / white / белый   |   |
| A-MEVO-235-20M  |   | czarny / black / чёрный   |   |
| A-MEVO-235-90   | szampan / champagne / шампань   |   |   |
| A-MEVO-300-05   | 3000  | aluminium / aluminium / алюминий  |   |
| A-MEVO-300-10A  |   | biały / white / белый   |   |
| A-MEVO-300-20M  |   | czarny / black / чёрный   |   |
| A-MEVO-300-90   | szampan / champagne / шампань   |   |   |
| A-MEVO-405-05   | 4050  | aluminium / aluminium / алюминий  |   |
| A-MEVO-405-10   |   | biały / white / белый   |   |
| A-MEVO-405-20M  |   | czarny / black / чёрный   |   |
| A-MEVO-405-90   | szampan / champagne / шампань   |   |   |



Tor dolny EVO 2  
Bottom track EVO 2  
Нижняя направляющая EVO 2



|  |  L<br>mm |  |  |
|---|---|---|---|
| A-TDEVO2-170-05   | 1700  | aluminium / aluminium / алюминий  | aluminium<br>aluminium<br>алюминий  |
| A-TDEVO2-170-90   |   | szampan / champagne / шампань   |   |
| A-TDEVO2-235-05   | 2350  | aluminium / aluminium / алюминий  |   |
| A-TDEVO2-235-90   |   | szampan / champagne / шампань   |   |
| A-TDEVO2-300-05   | 3000  | aluminium / aluminium / алюминий  |   |
| A-TDEVO2-300-90   |   | szampan / champagne / шампань   |   |
| A-TDEVO2-405-05   | 4050  | aluminium / aluminium / алюминий  |   |
| A-TDEVO2-405-90   |   | szampan / champagne / шампань   |   |
| A-TDEVO2-600-05   | 6000  | aluminium / aluminium / алюминий  |   |
| A-TDEVO2-600-90   |   | szampan / champagne / шампань   |   |



Tor dolny PRO  
Bottom track PRO  
Нижняя направляющая PRO



|  |  L<br>mm |  |  |
|---|---|---|---|
| A-TDPRO-170-05  | 1700  | aluminium / aluminium / алюминий  | aluminium<br>aluminium<br>алюминий  |
| A-TDPRO-170-10  |   | biały / white / белый   |   |
| A-TDPRO-170-20M   |   | czarny / black / чёрный   |   |
| A-TDPRO-170-90  |   | szampan / champagne / шампань   |   |
| A-TDPRO-235-05  | 2350  | aluminium / aluminium / алюминий  |   |
| A-TDPRO-235-10  |   | biały / white / белый   |   |
| A-TDPRO-235-20M   |   | czarny / black / чёрный   |   |
| A-TDPRO-235-90  |   | szampan / champagne / шампань   |   |
| A-TDPRO-300-05  | 3000  | aluminium / aluminium / алюминий  |   |
| A-TDPRO-300-10  |   | biały / white / белый   |   |
| A-TDPRO-300-20M   |   | czarny / black / чёрный   |   |
| A-TDPRO-300-90  |   | szampan / champagne / шампань   |   |
| A-TDPRO-405-05  | 4050  | aluminium / aluminium / алюминий  |   |
| A-TDPRO-405-10  |   | biały / white / белый   |   |
| A-TDPRO-405-20M   |   | czarny / black / чёрный   |   |
| A-TDPRO-405-90  |   | szampan / champagne / шампань   |   |
| A-TDPRO-600-05  | 6000  | aluminium / aluminium / алюминий  |   |
| A-TDPRO-600-10  |   | biały / white / белый   |   |
| A-TDPRO-600-20M   |   | czarny / black / чёрный   |   |
| A-TDPRO-600-90  |   | szampan / champagne / шампань   |   |



## Maskownica PRO Masking cover PRO Декоративная накладка PRO



|  |  L<br>mm |  |  |
|---|---|---|---|
| A-MPRO-170-05   | 1700  | aluminium / aluminium / алюминий  | aluminium<br>aluminium<br>алюминий  |
| A-MPRO-170-10   |   | biały / white / белый   |   |
| A-MPRO-170-20M  |   | czarny / black / чёрный   |   |
| A-MPRO-170-90   |   | szampan / champagne / шампань   |   |
| A-MPRO-235-05   | 2350  | aluminium / aluminium / алюминий  |   |
| A-MPRO-235-10   |   | biały / white / белый   |   |
| A-MPRO-235-20M  |   | czarny / black / чёрный   |   |
| A-MPRO-235-90   |   | szampan / champagne / шампань   |   |
| A-MPRO-300-05   | 3000  | aluminium / aluminium / алюминий  |   |
| A-MPRO-300-10   |   | biały / white / белый   |   |
| A-MPRO-300-20M  |   | czarny / black / чёрный   |   |
| A-MPRO-300-90   |   | szampan / champagne / шампань   |   |
| A-MPRO-405-05   | 4050  | aluminium / aluminium / алюминий  |   |
| A-MPRO-405-10   |   | biały / white / белый   |   |
| A-MPRO-405-20M  |   | czarny / black / чёрный   |   |
| A-MPRO-405-90   |   | szampan / champagne / шампань   |   |



## Listwa górna 18/4 mm Top strip 18/4 mm Профиль горизонтальный верхний 18/4 мм



|  |  L<br>mm |  |  |
|---|--|---|---|
| A-LG18-170-05*  | 1700   | aluminium / aluminium / алюминий  | aluminium<br>aluminium<br>алюминий  |
| A-LG18-170-90*  |  | szampan / champagne / шампань   |   |
| A-LG18-235-05*  | 2350   | aluminium / aluminium / алюминий  |   |
| A-LG18-235-90*  |  | szampan / champagne / шампань   |   |
| A-LG18-300-05   | 3000   | aluminium / aluminium / алюминий  |   |
| A-LG18-300-10   |  | biały / white / белый   |   |
| A-LG18-300-20M  |  | czarny / black / чёрный   |   |
| A-LG18-300-90   |  | szampan / champagne / шампань   |   |
| A-LG18-405-05*  | 4050   | aluminium / aluminium / алюминий  |   |
| A-LG18-405-10*  |  | biały / white / белый   |   |
| A-LG18-405-90*  |  | szampan / champagne / шампань   |   |
| A-LG18-600-05*  | 6000   | aluminium / aluminium / алюминий  |   |
| A-LG18-600-90*  |  | szampan / champagne / шампань   |   |





Listwa dolna 18/4 mm  
Bottom strip 18/4 mm  
Профиль горизонтальный нижний 18/4 мм



|  |  |  |  |
|---|---|---|---|
| A-LD18-170-05*  | 1700  | aluminium / aluminium / алюминий  | aluminium<br>aluminium<br>алюминий  |
| A-LD18-170-90*  |   | szampan / champagne / шампань   |   |
| A-LD18-235-05*  | 2350  | aluminium / aluminium / алюминий  |   |
| A-LD18-235-90*  |   | szampan / champagne / шампань   |   |
| A-LD18-300-05   | 3000  | aluminium / aluminium / алюминий  |   |
| A-LD18-300-10   |   | biały / white / белый   |   |
| A-LD18-300-20M  |   | czarny / black / чёрный   |   |
| A-LD18-300-90   |   | szampan / champagne / шампань   |   |
| A-LD18-405-05*  | 4050  | aluminium / aluminium / алюминий  |   |
| A-LD18-405-10*  |   | biały / white / белый   |   |
| A-LD18-405-90*  |   | szampan / champagne / шампань   |   |
| A-LD18-600-05*  |   | aluminium / aluminium / алюминий  |   |
| A-LD18-600-90*  | 6000  | szampan / champagne / шампань   |   |



\*Do wyczerpania zapasów / Until stocks run out / До исчерпания запасов

Listwa górna 19 mm  
Top strip 19 mm  
Профиль горизонтальный верхний 19 мм

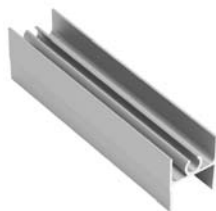

|  |  |  |  |
|---|---|---|---|
| A-LG19-300-05   | 3000  | aluminium<br>aluminium<br>алюминий  | aluminium<br>aluminium<br>алюминий  |



Listwa dolna 19 mm  
Bottom strip 19 mm  
Профиль горизонтальный нижний 19 мм

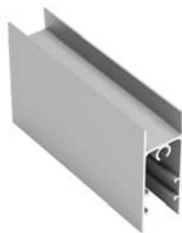





|   |   |   |   |
|---|---|---|---|
|  |  L<br>mm |  |  |
| A-LD19-300-05   | 3000  | aluminium<br>aluminium<br>алюминий  | aluminium<br>aluminium<br>алюминий  |

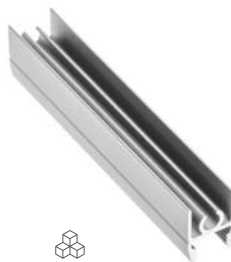

Listwa górna 10/4 mm  
Top strip 10/4 mm  
Профиль горизонтальный верхний 10/4 мм



|   |   |   |   |
|---|---|---|---|
|  |  L<br>mm |  |  |
| A-LG10-170-05*  | 1700  | aluminium / aluminium / алюминий  | aluminium<br>aluminium<br>алюминий  |
| A-LG10-235-05*  | 2350  | aluminium / aluminium / алюминий  |   |
| A-LG10-235-90*  |   | szampan / champagne / шампань   |   |
| A-LG10-300-05   | 3000  | aluminium / aluminium / алюминий  |   |
| A-LG10-300-10   |   | biały / white / белый   |   |
| A-LG10-300-20M  |   | czarny mat / black matt / чёрный матовый  |   |
| A-LG10-300-90   |   | szampan / champagne / шампань   |   |
| A-LG10-405-05*  | 4050  | aluminium / aluminium / алюминий  |   |
| A-LG10-405-90*  |   | szampan / champagne / шампань   |   |
| A-LG10-600-05*  | 6000  | aluminium / aluminium / алюминий  |   |
| A-LG10-600-90*  |   | szampan / champagne / шампань   |   |



Listwa dolna 10/4 mm  
Bottom strip 10/4 mm  
Профиль горизонтальный нижний 10/4 мм







|  | <br>L<br>mm |  |  |
|---|--|---|---|
| A-LD10-170-05*  | 1700   | aluminium / aluminium / алюминий  | aluminium<br>aluminium<br>алюминий  |
| A-LD10-235-05*  | 2350   | aluminium / aluminium / алюминий  |   |
| A-LD10-235-90*  |  | szampan / champagne / шампань   |   |
| A-LD10-300-05   | 3000   | aluminium / aluminium / алюминий  |   |
| A-LD10-300-10   |  | biały / white / белый   |   |
| A-LD10-300-20M  |  | czarny mat / black matt / чёрный матовый  |   |
| A-LD10-300-90   |  | szampan / champagne / шампань   |   |
| A-LD10-405-05*  | 4050   | aluminium / aluminium / алюминий  |   |
| A-LD10-405-90*  |  | szampan / champagne / шампань   |   |
| A-LD10-600-05*  | 6000   | aluminium / aluminium / алюминий  |   |
| A-LD10-600-90*  |  | szampan / champagne / шампань   |   |



\*Do wyczerpania zapasów / Until stocks run out / До исчерпания запасов

Listwa górna 4 mm  
Top strip 4 mm  
Профиль горизонтальный верхний 4 мм







|  | <br>L<br>mm |  |  |
|---|--|---|---|
| A-LG4MOV-300-05   | 3000   | aluminium / aluminium / алюминий  | aluminium<br>aluminium<br>алюминий  |



Listwa dolna 4 mm  
Bottom strip 4 mm  
Профиль горизонтальный нижний 4 мм



|   |  |   |   |
|---|--|---|---|
|  | <br>L<br>mm |  |  |
| A-LD4MOV-300-05   | 3000   | aluminium / aluminium / алюминий  | aluminium<br>aluminium<br>алюминий  |

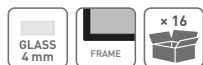

Listwa górna FL 10/4 mm  
Top strip FL 10/4 mm  
Профиль горизонтальный верхний FL 10/4 мм







|   |  |   |   |
|---|--|---|---|
|  | <br>L<br>mm |  |  |
| A-LG10FL-300-05   | 3000   | aluminium / aluminium / алюминий  | aluminium<br>aluminium<br>алюминий  |
| A-LG10FL-300-10   |  | biały / white / белый   |   |
| A-LG10FL-300-20M  |  | czarny mat / black matt / чёрный матовый  |   |
| A-LG10FL-300-90   |  | szampan / champagne / шампань   |   |



Listwa dolna FL 10,4 mm  
Bottom strip FL 10/4 mm  
Профиль горизонтальный нижний FL 10/4 мм







|  |  L<br>mm |  |  |
|---|---|---|---|
| A-LD10FL-300-05   | 3000  | aluminium / aluminium / алюминий  | aluminium<br>aluminium<br>алюминий  |
| A-LD10FL-300-10   |   | biały / white / белый   |   |
| A-LD10FL-300-20M  |   | czarny mat / black matt / чёрный матовый  |   |
| A-LD10FL-300-90   |   | szampa / champagne / шампань  |   |



Kątownik  
Angle bar  
Профиль угловой





|  |  L<br>mm |  |  |
|---|---|---|---|
| A-K18-300-05  | 3000  | aluminium / aluminium / алюминий  | aluminium<br>aluminium<br>алюминий  |
| A-K18-300-10  |   | biały / white / белый   |   |
| A-K18-300-20M   |   | czarny / black / чёрный   |   |
| A-K18-300-90  |   | szampa / champagne / шампань  |   |



Profil C18  
Profile C18  
Профиль C18







|  |  |  |  |
|---|---|---|---|
| A-C18-300-S-05  | 3000  | aluminium / aluminium / алюминий  | aluminium<br>aluminium<br>алюминий  |
| A-C18-300-S-10  |   | biały / white / белый   |   |
| A-C18-300-S-20M   |   | czarny mat / black matt / чёрный матовый  |   |
| A-C18-300-S-90  |   | szampan / champagne / шампань   |   |



Profil T18  
Profile T18  
Профиль T18







|  |  |  |  |
|---|---|---|---|
| A-T18-300-05  | 3000  | aluminium / aluminium / алюминий  | aluminium<br>aluminium<br>алюминий  |
| A-T18-300-10  |   | biały / white / белый   |   |
| A-T18-300-90  |   | szampan / champagne / шампань   |   |



Profil H16  
Profile H16  
Профиль H16







|  |  |  |  |
|---|---|---|---|
| A-H16-300-05  | 3000  | aluminium / aluminium / алюминий  | aluminium<br>aluminium<br>алюминий  |
| A-H16-300-90  |   | szampan / champagne / шампань   |   |





Profil H18  
 Profile H18  
 Профиль H18







|  |  L<br>mm |  |                           |
|---|---|---|--|
| A-H18-300-05  | 3000  | aluminium / aluminium / алюминий  | <br>aluminium<br>алюминий |
| A-H18-300-10*   |   | biały / white / белый   |  |
| A-H18-300-20M   |   | czarny / black / чёрный   |  |
| A-H18-300-90  |   | szampan / champagne / шампань   |  |



Profil H18 RA  
 Profile H18 RA  
 Профиль H18 RA







|  |  L<br>mm |  |                           |
|---|---|---|--|
| A-HR18-300-05RA   | 3000  | aluminium / aluminium / алюминий  | <br>aluminium<br>алюминий |
| A-HR18-300-90RA   |   | szampan / champagne / шампань   |  |



Profil HR18  
Profile HR18  
Профиль HR18







|  | <br>mm |  |  |
|---|---|---|---|
| A-HR18-300-05   | 3000  | aluminium / aluminium / алюминий  | aluminium<br>aluminium<br>алюминий  |
| A-HR18-300-10   |   | biały / white / белый   |   |
| A-HR18-300-20M  |   | czarny / black / чёрный   |   |
| A-HR18-300-90   |   | szampan / champagne / шампань   |   |



Profil HRS18  
Profile HRS18  
Профиль HRS18



|  | <br>mm |  |  |
|---|---|---|---|
| A-HRS18-170-05  | 1700  | aluminium / aluminium / алюминий  | aluminium<br>aluminium<br>алюминий  |
| A-HRS18-170-90  |   | szampan / champagne / шампань   |   |
| A-HRS18-235-05  | 2350  | aluminium / aluminium / алюминий  |   |
| A-HRS18-235-90  |   | szampan / champagne / шампань   |   |
| A-HRS18-300-05  | 3000  | aluminium / aluminium / алюминий  |   |
| A-HRS18-300-90  |   | szampan / champagne / шампань   |   |
| A-HRS18-405-05  | 4050  | aluminium / aluminium / алюминий  |   |
| A-HRS18-405-90  |   | szampan / champagne / шампань   |   |
| A-HRS18-600-05  | 6000  | aluminium / aluminium / алюминий  |   |
| A-HRS18-600-90  |   | szampan / champagne / шампань   |   |



Profil HR19  
Profile HR19  
Профиль HR19

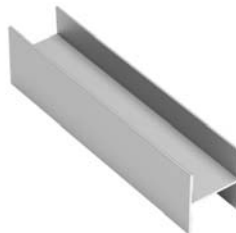









|  | <br>mm |  |  |
|---|---|---|---|
| A-HR19-300-05   | 3000  | aluminium / aluminium / алюминий  | aluminium / aluminium / алюминий  |











Profil HR10  
Profile HR10  
Профиль HR10

|  |  L<br>mm |  |  |
|---|---|---|---|
| A-HR10-235-05*  | 2350  |  | aluminium / aluminium / алюминий<br>szampan / champagne / шампань                 |
| A-HR10-235-90*  |   |   |   |
| A-HR10-300-05   | 3000  |  | aluminium / aluminium / алюминий<br>biały / white / белый                         |
| A-HR10-300-10   |   |   |   |
| A-HR10-300-90   | 4500  |  | aluminium / aluminium / алюминий<br>szampan / champagne / шампань                 |
| A-HR10-405-05*  |   |   |   |
| A-HR10-405-90*  | 6000  |  | aluminium / aluminium / алюминий<br>szampan / champagne / шампань                 |
| A-HR10-600-05*  |   |   |   |
| A-HR10-600-90*  |   |   | aluminium<br>aluminium<br>алюминий  |



\* Do wyczerpania zapasów / Until stocks run out / До исчерпания запасов



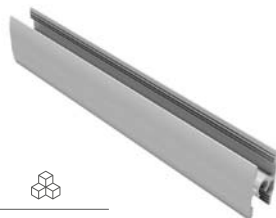

Profil HRS10  
Profile HRS10  
Профиль HRS10

|  |  L<br>mm |  |  |
|---|---|---|---|
| A-HRS10-170-05*   | 1700  |  | aluminium / aluminium / алюминий  |
| A-HRS10-300-05  | 3000  |   |   |
| A-HRS10-300-90  | 4050  |  | szampan / champagne / шампань   |
| A-HRS10-405-05*   | 6000  |   |   |
| A-HRS10-600-05*   |   |   | aluminium<br>aluminium<br>алюминий  |



\* Do wyczerpania zapasów / Until stocks run out / До исчерпания запасов



Profil HR10 FL  
Profile HR10 FL  
Профиль HR10 FL

|  |  L<br>mm |  |  |
|---|---|---|---|
| A-HR10FL-300-05   | 3000  |  | aluminium / aluminium / алюминий  |
| A-HR10FL-300-10   |   |   |   |
| A-HR10FL-300-20M  |   |   |   |
| A-HR10FL-300-90   |   |   |   |
|   |   |   | aluminium<br>aluminium<br>алюминий  |



Prowadnik górny PG-18  
Top roller PG-18  
Верхний ролик PG-18





|   |   |   |
|---|---|---|
|  |  |  |
| A-PG-18   | 50  | stal, tworzywo<br>steel, plastic<br>сталь, пластмасса                             |



Prowadnik górny PGR-18  
Top roller PGR-18  
Верхний ролик PGR-18





|   |   |   |
|---|---|---|
|  |  |  |
| A-PGR-18  | 50  | stal, tworzywo<br>steel, plastic<br>сталь, пластмасса                             |



Prowadnik górny PGR-10  
Top roller PGR-10  
Верхний ролик PGR-10





|   |   |   |
|---|---|---|
|  |  |  |
| A-PGR-10  | 50  | stal, tworzywo<br>steel, plastic<br>сталь, пластмасса                               |



Prowadnik górny PGR-10 symetryczny  
 Top roller PGR-10 symmetrical  
 Верхний ролик PGR-10 симметричный





|   |   |   |
|---|---|---|
|  |  |  |
| A-PGR-10S   | 50  | stal, tworzywo<br>steel, plastic<br>сталь, пластмасса                             |



Płytk dystansowa  
 Spacer plate  
 Распорная пластина





|   |   |   |
|---|---|---|
|  |  |  |
| A-DPG-16  | 50  | stal<br>steel<br>сталь  |





Wózek dolny EVO 2  
 Bottom roller EVO 2  
 Нижний ролик EVO 2



|   |   |   |
|---|---|---|
|  |  |  |
| A-WD-EVO2   | 50  | stal / tworzywo<br>steel / plastic<br>сталь / пластмасса                            |





Zaczer EVO 2  
Guide EVO 2  
Проводник EVO 2

|   |   |   |
|---|---|---|
|  |  |  |
| A-ZAC-WDEV02  | 50  | stal, tworzywo<br>steel, plastic<br>сталь, пластмасса                             |





Wózek dolny PRO  
Bottom roller PRO  
Нижний ролик PRO

|   |   |   |
|---|---|---|
|  |  |  |
| A-WD-PRO  | 50  | stal, tworzywo<br>steel, plastic<br>сталь, пластмасса                             |





Wózek dolny EVO rama  
Bottom roller EVO frame  
Нижний ролик EVO для рамной системы

|   |   |   |
|---|---|---|
|  |  |  |
| A-WDR-EVO   | 50  | stal, tworzywo<br>steel, plastic<br>сталь, пластмасса                               |





Wózek dolny PRO rama  
Bottom roller PRO frame  
Нижний ролик PRO для рамной системы

|   |   |   |
|---|---|---|
|  |  |  |
| A-WDR-PRO   | 50  | stal, tworzywo<br>steel, plastic<br>сталь, пластмасса                             |





Pozycjoner górny  
Top positioner  
Верхний стопор

|   |   |   |
|---|---|---|
|  |  |  |
| A-PTG   | 50  | tworzywo<br>plastic<br>пластмасса   |



Pozycjoner dolny PRO  
Bottom positioner PRO  
Нижний стопор PRO

|   |   |   |
|---|---|---|
|  |  |  |
| A-PTD   | 50  | stal<br>steel<br>сталь  |



Szczotka odbojowa 4,8 x 4 mm  
Buffer strip 4,8 x 4 mm  
Буферная щётка 4,8 x 4 мм





|   |   |   |
|---|---|---|
|  |  |  |
| A-SO-48X4   | szary / gray / серый  | tworzywo plastic<br>пластмасса  |
| A-SO-48X4-20  | czarny / black / чёрный   |   |



Szczotka odbojowa szeroka 14,5 x 4 mm  
Buffer strip wide 14,5 x 4 mm  
Буферная щётка широкая 4,8 x 4 мм



|   |   |   |
|---|---|---|
|  |  |  |
| A-SO-145X4  | szary / gray / серый  | tworzywo plastic<br>пластмасса  |
| A-SO-145X4-10   | biały / white / белый   |   |
| A-SO-145X4-20   | czarny / black / чёрный   |   |



Szczotka przeciwkurzowa bez kleju 4,8 x 7 mm  
Anti-dust strip without glue 4,8 x 7 mm  
Противопылевая щётка без клея 4,8 x 7 мм



|   |   |   |
|---|---|---|
|  |  |  |
| A-SP-48X7   | szary<br>gray<br>серый  | tworzywo plastic<br>пластмасса  |



Szczotka przeciwkurzowa z klejem 7 x 12 mm  
 Anti-dust strip with glue 7 x 12 mm  
 Противопылевая щётка на клеевой основе 7 x 12 мм



|   |   |   |
|---|---|---|
|  |  |  |
| A-SP-7X12   | szary<br>gray<br>серый  | tworzywo<br>plastic<br>пластмасса   |



Szczotka przeciwkurzowa bez kleju 4,8 x 12 mm  
 Anti-dust strip without glue 4,8 x 12 mm  
 Противопылевая щётка 4,8 x 12 мм (вставная)



|   |   |   |
|---|---|---|
|  |  |  |
| A-SP-48X12  | szary<br>gray<br>серый  | tworzywo<br>plastic<br>пластмасса   |



Klin do rączek  
 Wedge for handle  
 Клиn для профиль-ручки





|   |   |   |
|---|---|---|
|  |  |  |
| A-KR-4  | biały / white / белый   | tworzywo<br>plastic<br>пластмасса   |
| A-KR-4-20   | czarny / black / чёрный   |   |



Klin do listew poziomych  
Wedge for horizontal strips  
Клин для горизонтальных профилей



|   |   |   |
|---|---|---|
|  |  |  |
| A-KLP-4   | biały / white / белый   | tworzywo<br>plastic<br>пластмасса   |
| A-KLP-4-20  | czarny / black / чёрный   |   |



Klips do mocowania toru dolnego EVO 2  
Mounting clip for bottom track EVO 2  
Клипса для крепления нижней направляющей EVO 2



|   |   |   |
|---|---|---|
|  |  |  |
| A-ZAT-TDEV02  | mleczny<br>milk<br>молочный   | tworzywo<br>plastic<br>пластмасса   |



Uszczelka typ U, średnio twarda  
Gasket U, medium hard  
Уплотнитель тип U, средней твердости





|   |   |   |   |
|---|---|---|---|
|  |  |  |  |
| A-USZCZ-U4  | 100   | przeźroczysty<br>transparent<br>прозрачный  | tworzywo<br>plastic<br>пластмасса   |





Uszczelka typ CH, miękka  
Gasket CH, soft  
Уплотнитель типа CH, мягкий







|  |  L<br>m |  |  |
|---|--|---|---|
| A-USZCZ-CHM4  | 120  | przeźroczysty / transparent / прозрачный  | tworzywo<br>plastic<br>пластмасса   |
| A-USZCZ-CHM4-20   | 150  | czarny / black / чёрный   |   |



Uszczelka do toru dolnego EVO 2  
Gasket for EVO 2 track  
Уплотнитель для нижней направляющей EVO 2



|  |  L<br>m |  |  |
|---|--|---|---|
| A-USZCZ-TDEVO2  | 200  | mleczny<br>milk<br>молочный   | PVC   |



Błachowkręt 6,3 x 40 mm  
Steel metal screw 6,3 x 40 mm  
Сборочный винт 6,3 x 40 мм



|  |  |
|---|---|
| A-B63-40  | stal<br>steel<br>сталь  |



Blachowkręt 6,3 x 32 mm  
Steel metal screw 6,3 x 32 mm  
Сборочный винт 6,3 x 32 мм





|   |   |
|---|---|
|  |  |
| A-B63-32*   | stal<br>steel<br>сталь  |



\*Do wyczerpania zapasów / Until stocks run out / До исчерпания запасов

Spowalnicz SIMON skrajny  
Internal soft closing damper SIMON  
Боковой доводчик SIMON



|   |   |   |
|---|---|---|
|  |  |  |
| A-SOFT-30*  | 30  | stal, tworzywo<br>steel, plastic<br>сталь, пластмасса                             |
| A-SOFT-50*  | 50  |   |



\* Do wyczerpania zapasów / Until stocks run out / До исчерпания запасов





Spowalnicz SIMON środkowy  
Internal soft closing damper SIMON  
Центральный доводчик SIMON

|   |   |   |
|---|---|---|
|  |  |  |
| A-MSOFT-RAMA  | 50  | stal, tworzywo<br>steel, plastic<br>сталь, пластмасса                             |





Spowalnicz ZIMMER skrajny  
Internal soft closing damper ZIMMER  
Боковой доводчик ZIMMER

|   |   |   |
|---|---|---|
|  |  |  |
| A-SOFT-30Z  | 30  | stal, tworzywo<br>steel, plastic<br>сталь, пластмасса                               |
| A-SOFT-50Z  | 50  |   |





Zestaw adaptera do spowalnicza środkowego  
 Adapter set for soft closing damper  
 Адаптер для доводчика

|   |   |   |
|---|---|---|
|  |  |  |
| A-MSOFT-ADAPT   | 50  | stal<br>steel<br>сталь  |





Zamek do systemów przesuwnych  
 Lock for sliding door systems  
 Замок для раздвижных систем

|   |   |
|---|---|
|  |  |
| ZZ-SP-105-05  | stal, tworzywo<br>steel, plastic<br>сталь, пластмасса                             |



Ręczny przyrząd wiertarski z dociskiem  
 Hand drilling tool with locking screws  
 Ручной сверлильный кондуктор с зажимом

|   |   |
|---|---|
|  |  |
| A-PW-RC-DOC   | stal<br>steel<br>сталь  |



MITO  
MITO  
MITO

|  |   |                |     |    |  |   |      |
|--|---|----------------|-----|----|--|---|------|
|  | Tor MITO<br>Track MITO<br>Направляющая MITO   | A-TMITO-200-00 | 200 | 50 | surowe aluminium<br>raw aluminum<br>сырой алюминий | aluminium<br>aluminium<br>алюминий                    | 56   |
|  |   | A-TMITO-250-00 | 250 |    |  |   |      |
|  |   | A-TMITO-300-00 | 300 |    |  |   |      |
|  |   | A-TMITO-200-05 | 200 |    | aluminium<br>aluminium<br>алюминий                 |   |      |
|  |   | A-TMITO-250-05 | 250 |    |  |   |      |
|  |   | A-TMITO-300-05 | 300 |    |  |   |      |
|  | Pozycjoner<br>Positioner<br>Стопор  | A-POZ-MITO     | -   |    | szary<br>gray<br>серый                             | tworzywo<br>plastic<br>пластмасса                     | 2000 |
|  | Wózek górny<br>Top guide<br>Верхний проводник   | A-SG-MITO      | -   |    | ocynk<br>zink<br>оцинковка                         | stal, tworzywo<br>steel, plastic<br>сталь, пластмасса | 400  |
|  | Wózek dolny<br>z łożyskiem kulkowym<br>Bottom roller<br>with ball bearing<br>Нижний ролик<br>с шариковым<br>подшипником | A-RD-MITO      | -   |    |  |   |      |

Zestaw MITO PLUS  
MITO PLUS set  
MITO PLUS комплект

2 wózki górne ze sprężyną, 2 wózki dolne z łożyskiem kulkowym, 1 pozycjoner, komplet wkrętów

2 top rollers with spring, 2 bottom ball bearing rollers, 1 positioner, set of screws

2 верхних проводника с пружиной, 2 нижних ролика с шариковым подшипником, 1 стопор, комплект шурупов



|             |    |                          |                      |
|-------------|----|--------------------------|----------------------|
| A-MITO-PLUS | 50 | ocynk / zink / оцинковка | stal / steel / сталь |
|-------------|----|--------------------------|----------------------|



Zestaw OVERLINE  
OVERLINE set  
OVERLINE комплект



2 szt. wózków zewnętrznych, 2 szt. wózków wewnętrznych, 2 szt. pozycjonerów, 2 szt. prowadników dolnych ślizgowych drzwi zewnętrznych, 2 szt. prowadników dolnych ślizgowych drzwi wewnętrznych

2 external rollers, 2 internal rollers, 2 positioners, 2 bottom slides for external door, 2 bottom slides of internal door

Внешние ролики-2шт., внутренние ролики-2шт., нижние ходовые элементы внешней двери-2 шт., нижние ходовые элементы внутренней двери-2 шт., позиционер-2 шт

|           |    |                          |   |    |
|-----------|----|--------------------------|---|----|
|           |    |                          |   |    |
| A-SN-FSET | 50 | ocynk / zink / оцинковка | stal, tworzywo / steel, plastic / сталь, пластмасса | 10 |

|  | A-SN-R19RIV-270-05 | -    | aluminium aluminium алюминий | 24  |                  |    |
|--|--------------------|------|------------------------------|---|------------------|----|
|  | A-SN-K19-270-05    | -    |                              | 48  |                  |    |
|  | A-C18-300-S-05     | -    |                              | 50  |                  |    |
|  | A-SN-TG-405-00     | 4050 | 50                           | surowe aluminium raw aluminium сырой алюминий   | stal steel сталь | 80 |
|  | A-SN-TDS-405-00    |      |                              | aluminium aluminium алюминий                    | 40               |    |
|  | A-SN-SOFT-25       | -    | szary gray серый             | tworzywo plastic пластмасса                     | 100              |    |
|  | A-SN-SOFT-40       | -    |                              |   |                  | 40 |
|  | A-SN-ADSET         | -    | -                            | stal, tworzywo steel, plastic сталь, пластмасса | 100              |    |



## Zestaw OVERLINE PLUS

### OVERLINE PLUS set

### OVERLINE PLUS комплектация



2 szt. wózków zewnętrznych, 2 szt. wózków wewnętrznych, 2 szt. prowadników dolnych tocznych drzwi zewnętrznych, 2 szt. prowadników dolnych tocznych drzwi wewnętrznych, 1 zestaw wkrętów

2 external rollers, 2 internal rollers, 2 bottom slides for external door, 2 bottom slides for internal door, screws

Составляющие: внешние ролики – 2шт., внутренние ролики – 2шт., нижние ходовые элементы внешней двери – 2 шт., нижние ходовые элементы внутренней двери – 2 шт., 1 кпл. шурупов

|   |    |  |  |  |  |   |     |
|---|---|---|---|---|--|---|-----|
| A-SN-HSET1  | 50  | ocynk / zink / оцинковка  | stal, tworzywo / steel, plastic / сталь, пластмасса                               | 1   |  |   |     |
|    | Rączka RIVA<br>Handle RIVA<br>Ручка RIVA  | A-SN-R19RIV-270-05  | 2700  | -   |  | 24  |     |
|    | Profil C19<br>Handle C19<br>Ручка C19   | A-SN-K19-270-05   |   | -   | aluminium<br>aluminium<br>алюминий   | aluminium<br>aluminium<br>алюминий                    | 48  |
|    | Profil C18<br>Handle C18<br>Ручка C18   | A-C18-300-S-05  | 3000  | -   |  | 50  |     |
|    | Tor górny<br>Top track<br>Верхняя направляющая  | A-SN-TG-405-00  | 4050  | -   | surowe<br>aluminium<br>raw<br>aluminium<br>сырой<br>алюминий                       | stal<br>steel<br>сталь                                | 80  |
|   | Tor dolny<br>Bottom track<br>Нижняя направляющая  | A-SN-TDT-405-00   |   | -   |  | aluminium<br>aluminium<br>алюминий                    | 20  |
|  | Spowalniacz<br>Soft closing damper<br>доводчик  | A-SN-SOFT-25  | -   | 25  | -  | tworzywo<br>plastic<br>пластмасса                     | 100 |
|   |   | A-SN-SOFT-40  | -   | 40  | -  |   | 20  |
|  | Pozycjoner<br>Positioner<br>Стоп  | A-SN-POZ  | -   | -   | czarny<br>black<br>черный  |   | 20  |
|  | Zestaw do spowalniacza<br>Soft closing damper set<br>доводчик комплектация<br>1 szt. aktywator drzwi zewn.<br>i 1 szt. wewn.,<br>4 szt. adapterów,<br>1 zestaw wkrętów<br>1 pc activator outer door<br>and 1 pc inner door,<br>4 pcs adapter,<br>1 screw set<br>активатор внеш. двери<br>- 1 шт., активатор внутр.<br>двери - 1 шт., адаптер - 4 шт.,<br>1 кпл. шурупов | A-SN-ADSET  | -   | -   | -  | stal, tworzywo<br>steel, plastic<br>сталь, пластмасса | 100 |

## Prostownica Warped door straightener Стяжка-выпрямитель



2 szt. listwy ściągające, 2 szt. płytki naciągające, 4 szt. płytki dociskowej, zaślepka, tuleja pozycjonująca, klucz do regulacji  
Tightening strip - 2 pcs, tensioning plate - 2 pcs, pressure plate - 4 pcs, cover cap, positioning sleeve, adjustment spanner  
Планка с резьбой - 2 шт., натяжная пластина - 2 шт., прижимная пластина - 4 шт., заглушка, зажимная гильза, ключ для регулировки



A-SN-SDP-TU

50

ocynk / zink / оцинковка

stal, tworzywo / steel, plastic / сталь, пластмасса

BOARD  
16-22mm

x 10



Zestaw QUANTUM  
 QUANTUM set  
 Комплект QUANTUM



2 szt. wózków, 2 szt. stoperów, 2 szt. przewodników, komplet wkrętów  
 Rollers - 2 pcs, stoppers - 2 pcs, guide - 2 pcs, screw set  
 Ролики - 2 шт., стопор - 2 шт., проводник - 2 шт., комплект шурупов

|            |    |                                  |   |    |
|------------|----|----------------------------------|---|----|
|            |    |                                  |   |    |
| A-BUDP-SET | 50 | aluminium / aluminium / алюминий | stal, tworzywo / steel, plastic / сталь, пластмасса | 24 |

| <p>Tor górny<br/>                     Top track<br/>                     Верхняя направляющая</p>  | A-TG-BUD-200-00 | 2000 | 50                         | surowe aluminium<br>raw aluminium<br>сырой алюминий | aluminium<br>aluminium<br>алюминий | 15  |
|--|-----------------|------|----------------------------|---|------------------------------------|-----|
|  | A-TG-BUD-300-00 | 3000 |                            |   |                                    |     |
| <p>Uchwyt boczny<br/>                     Side holder<br/>                     Боковое крепление</p>   | A-BUD-UB        | -    |                            | ocynk<br>zink<br>оцинковка                          | stal<br>steel<br>сталь             | 200 |
| <p>Uchwyt górny<br/>                     Top holder<br/>                     Верхнее крепление</p>   | A-BUD-UG        | -    |                            | aluminium<br>aluminium<br>алюминий                  | aluminium<br>aluminium<br>алюминий | 250 |
| <p>Uchwyt maskownicy toru górnego<br/>                     Top track masking cover holder<br/>                     Держатель декоративной панели</p> | A-BUD-UM        | 60   |                            |   |                                    |     |
| <p>Uchwyt do ramy (4 szt.)<br/>                     Frame holder (4 pcs)<br/>                     Крепление плиты (4 шт.)</p>                        | A-BUD-UR        | -    |                            |   |                                    |     |
| <p>Uchwyt do płyty<br/>                     Board holder<br/>                     Держатель для плиты</p>  | A-BUD-UP        | -    | ocynk<br>zink<br>оцинковка | stal<br>steel<br>сталь                              |                                    |     |





Zestaw LOFT  
LOFT set  
Комплект LOFT



2 szt. wózków, prowadnik, tor 2 m, 5 sztuk tulei dystansowych, 2 szt. odbojników, 2 szt. zabezpieczeń przed wypadnięciem drzwi, 2 szt. spawalniaczy, 2 szt. aktywatorów, komplet wkrętów i śrub

Roller – 2 pcs, slide – 1 pc, track 2 m, distance sleeve – 5 pcs, bumper 2 pcs, stopper preventing door from falling out – 2 pcs, soft closing damper – 2 pcs, activator – 2 pcs, screw set

Ролик – 2 шт., prowadnik – 1 шт., Направляющая 2 м, Амортизатор – 2 шт., блокада – 2 шт., доводчик – 2 шт., активатор – 2 шт., кпл. шурупов



|                    |     |                         |   |   |
|--------------------|-----|-------------------------|---|---|
| A-SN-LOFT-200-20MN | 100 | czarny / black / чёрный | stal, tworzywo / steel, plastic / сталь, пластмасса | 1 |
|--------------------|-----|-------------------------|---|---|



Polecany uchwyt w stylu loft - UZ-STEP-160-20M  
Recommended loft-style handle - UZ-STEP-160-20M  
Рекомендуем ручку в стиле лофт - UZ-STEP-160-20M



**OŚWIETLENIE MEBLOWE  
FURNITURE LIGHTING  
МЕБЕЛЬНОЕ ОСВЕЩЕНИЕ**

|   |           |
|---|-----------|
| Taśmy LED<br>LED strips<br>Светодиодные ленты                       | 526 – 531 |
| Profile LED<br>LED profiles<br>Профили LED                          | 532 – 563 |
| Oprawy LED<br>LED fittings<br>Светодиодные светильники              | 563 – 573 |
| Aksesoria<br>Accessories<br>Аксессуары                              | 574 – 601 |
| Przedłużacze biurkowe<br>Desk power sockets<br>Выдвижные удлинители | 602 – 623 |

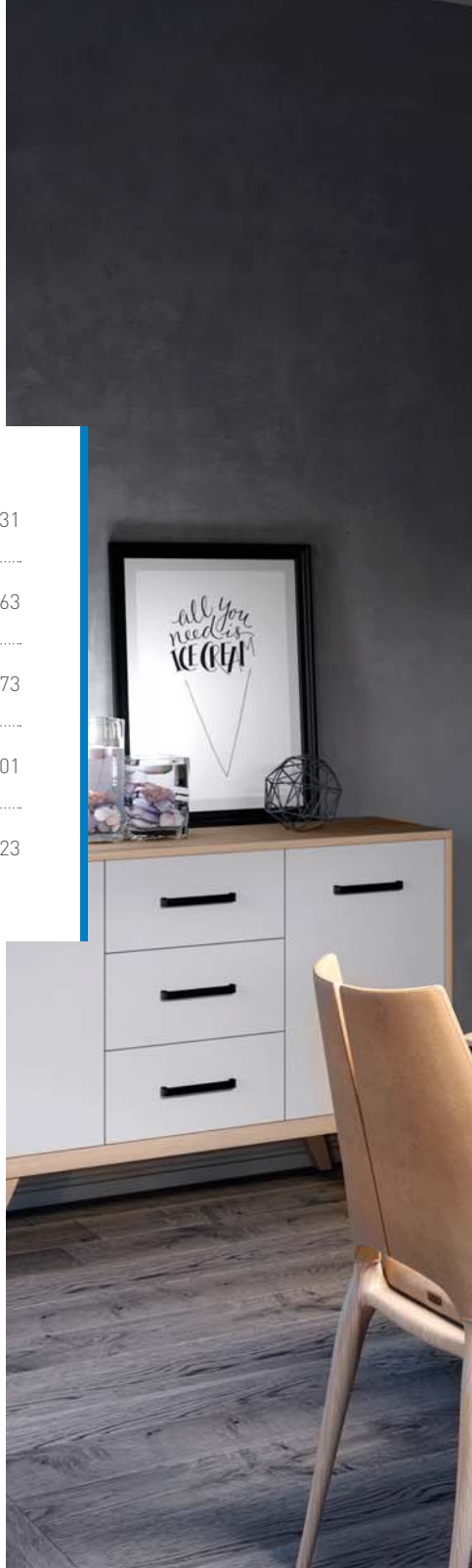





W 5-ciu krokach skompletuj zestaw EASY CLICK  
Complete the EASY CLICK set in 5 steps  
Завершите набор EASY CLICK за 5 шагов



1.

wybierz taśmę  
select LED strip  
выбрать светодиодную ленту

wybierz ilość odcinków taśm led  
select the number of sections of LED strips  
выбрать количество секций светодиодных лент

2.

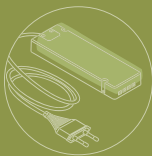

3.

dopasowany zasilacz  
matched power supply  
согласованный источник  
питания

wybierz profil, profile sprzedawane są jako  
gotowe 2 m zestawy, zawierające profil,  
ostonkę i 2 zaślepki

select profile profiles are sold as ready  
-made 2 m sets containing a profile,  
a cover and 2 end caps

Выбери профиль, отдельные профили продаются  
в виде готовых комплектов по 2 м, содержащих  
профиль, крышку и 2 торцевые заглушки

4.

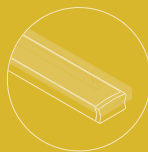

5.

wybierz włącznik  
select a switch  
выберите переключатель

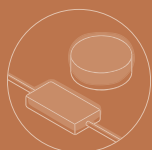

przed złożeniem  
before mounting  
перед монтажом

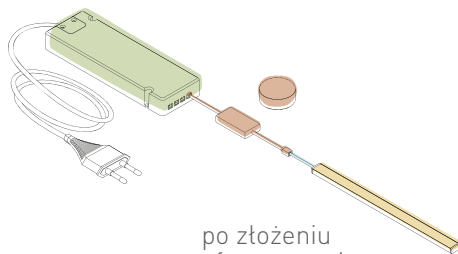

po złożeniu  
after mounting  
после монтажа

przykładowy schemat instalacji  
sample installation diagram  
примерная схема монтажа



taśma led w profilu  
LED strip in a profile  
светодиодная лента в профиле

przewód od taśmy led  
do wyłącznika  
кабель от светодиодной ленты  
к выключателю

••••• cable from LED strip to a switch  
кабель от светодиодной ленты  
к выключателю

••••• przewody wyłącznika  
switch cables  
кабель выключателя

••••• przewód od gniazda 230V  
do zasilacza  
cable from 230V mains  
socket to LED driver  
кабель от розетки 230

••••• wyłącznik  
switch  
выключатель

••••• zasilacz  
LED driver  
трансформатор

  
easy click

ТаЅма LED FLASH  
LED strip FLASH  
Светоодиодная лента FLASH



| LD-3528-300-20-ZB   | 12 VDC<br>4,8 W/1 m<br>17 W/5 m | 300 lm/m  |                         | 6500 K | 20 | 120° | 8  | 60/m  | 5   |
|---------------------|---------------------------------|-----------|-------------------------|--------|----|------|----|-------|-----|
| LD-3528-300-20-NE4P |                                 |           |                         | 4000 K |    |      |    |       |     |
| LD-3528-300-20-CB   |                                 |           |                         | 3200 K |    |      |    |       |     |
| LD-3528-300-65-ZB   |                                 | 280 lm/m  |                         | 6500 K | 65 |      |    |       |     |
| LD-3528-300-65-NE4  |                                 |           |                         | 4000 K |    |      |    |       |     |
| LD-3528-300-65-CB   |                                 |           |                         | 3200 K |    |      |    |       |     |
| LD-3528-300-20-NI   | -                               | -         | niebieski/ blue / синий |        | -  | -    | -  | -     |     |
| LD-3528-600-20-ZB   | 12 VDC<br>9,6 W/1 m<br>28 W/5 m | 550 lm/m  |                         | 6500 K | 20 | 120° | 8  | 120/m | 2,5 |
| LD-3528-600-20-NE4  |                                 |           |                         | 4000 K |    |      |    |       |     |
| LD-3528-600-20-CB   |                                 |           |                         | 3200 K |    |      |    |       |     |
| LD-3528-600-65-ZB   |                                 | 520 lm/m  |                         | 6500 K | 65 |      |    |       |     |
| LD-3528-600-65-NE4  |                                 |           |                         | 4000 K |    |      |    |       |     |
| LD-3528-600-65-CB   |                                 |           |                         | 3200 K |    |      |    |       |     |
| LD-2835-300-20-ZB   | 12 VDC<br>6 W/1 m<br>21 W/5 m   | 750 lm/m  |                         | 6500 K | 20 | 120° | 8  | 60/m  | 5   |
| LD-2835-300-20-NE4P |                                 |           |                         | 4000 K |    |      |    |       |     |
| LD-2835-300-20-CB   |                                 |           |                         | 3200 K |    |      |    |       |     |
| LD-2835-300-65-ZB   |                                 | 700 lm/m  |                         | 6500 K | 65 |      |    |       |     |
| LD-2835-300-65-NE4  |                                 |           |                         | 4000 K |    |      |    |       |     |
| LD-2835-300-65-CB   |                                 |           |                         | 3200 K |    |      |    |       |     |
| LD-2835-300-20-CBN  | 12 VDC<br>11 W/1 m<br>33 W/5 m  | 1000 lm/m |                         | 3200 K | 20 | 120° | 8  | 120/m | 2,5 |
| LD-2835-300-20-ZBN  |                                 |           |                         | 6500 K |    |      |    |       |     |
| LD-2835-300-20-NE4N |                                 |           |                         | 4000 K |    |      |    |       |     |
| LD-2835-300-65-CBN  |                                 | 900 lm/m  |                         | 3200 K | 65 |      |    |       |     |
| LD-2835-300-65-ZBN  |                                 |           |                         | 6500 K |    |      |    |       |     |
| LD-2835-300-65-NE4N |                                 |           |                         | 4000 K |    |      |    |       |     |
| LD-2835-600-20-ZB   | 12 VDC<br>19 W/1 m<br>60 W/5 m  | 1600 lm/m |                         | 6500 K | 20 | 120° | 10 | 120/m | 2,5 |
| LD-2835-600-20-NE4  |                                 |           |                         | 4000 K |    |      |    |       |     |
| LD-2835-600-20-CB   |                                 |           |                         | 3200 K |    |      |    |       |     |
| LD-2835-600-65-ZB   |                                 | 1350 lm/m |                         | 6500 K | 65 |      |    |       |     |
| LD-2835-600-65-NE4  |                                 |           |                         | 4000 K |    |      |    |       |     |
| LD-2835-600-65-CB   |                                 |           |                         | 3200 K |    |      |    |       |     |





|                        |  |           |                        |    |      |    |       |      |
|------------------------|--|-----------|------------------------|----|------|----|-------|------|
| LD-2835-600-5MM-20-ZB  | 12 VDC<br>10 W/1 m<br>33 W/5 m         | 750 lm/m  | ● 6500 K               | 20 | 120° | 5  | 120/m | 2,5  |
| LD-2835-600-5MM-20-NE4 |  |           | ● 4000 K               |    |      |    |       |      |
| LD-2835-600-5MM-20-CB  |  |           | ● 3200 K               |    |      |    |       |      |
| LD-2835-60-60-20-CCT   | 12 VDC<br>10 W/1 m<br>30 W/5 m         | 700 lm/m  | ● 3200 K<br>- ● 6500 K | 20 | 120° | 8  |       | 5    |
| LD-5050-300-20-ZB      | 12 VDC<br>14,4 W/1 m<br>44 W/5 m       | 900 lm/m  | ● 6500 K               | 65 | 120° | 10 | 60/m  | 5    |
| LD-5050-300-20-NE4     |  |           | ● 4000 K               |    |      |    |       |      |
| LD-5050-300-20-CB      |  |           | ● 3200 K               |    |      |    |       |      |
| LD-5050-300-65-ZB      | 14,4 W/1 m<br>44 W/5 m                 | 850 lm/m  | ● 6500 K               | 65 | 120° | 10 | 60/m  | 5    |
| LD-5050-300-65-NE4     |  |           | ● 4000 K               |    |      |    |       |      |
| LD-5050-300-65-CB      |  |           | ● 3200 K               |    |      |    |       |      |
| LD-5630-300-20-ZB      | 12 VDC<br>16 W/1 m<br>50 W/5 m         | 1750 lm/m | ● 6500 K               | 20 | 120° | 10 | 240/m | 1,25 |
| LD-5630-300-20-NE4     |  |           | ● 4000 K               |    |      |    |       |      |
| LD-5630-300-20-CB      |  |           | ● 3200 K               |    |      |    |       |      |
| LD-5630-300-65-ZB      | 16 W/1 m<br>50 W/5 m                   | 1700 lm/m | ● 6500 K               | 65 | 120° | 10 | 240/m | 1,25 |
| LD-5630-300-65-NE4     |  |           | ● 4000 K               |    |      |    |       |      |
| LD-5630-300-65-CB      |  |           | ● 3200 K               |    |      |    |       |      |
| LD-3014-1200-20-ZB     | 12 VDC<br>19 W/1 m<br>53 W/5 m         | 1300 lm/m | ● 6500 K               | 20 | 120° | 10 | 240/m | 1,25 |
| LD-3014-1200-20-NE4    |  |           | ● 4000 K               |    |      |    |       |      |
| LD-3014-1200-20-CB     |  |           | ● 3200 K               |    |      |    |       |      |
| LD-RGB-150-20          | 12 VDC<br>max 7,2<br>W/1 m<br>22 W/5 m | -         | ● RGB                  | 65 | 120° | 10 | 30/m  | 10   |
| LD-RGB-150-65          | 12 VDC<br>max 7,2<br>W/1 m<br>22 W/5 m | -         | ● RGB                  | 65 | 120° | 10 | 30/m  | 10   |
| LD-RGBW-300-20         | 12 VDC<br>max 17<br>W/1 m              | -         | ● RGBW                 | 20 | 120° | 10 | 60/m  | 5    |



ТаЅма LED FLASH 50 m  
LED strip FLASH 50 m  
Светодиодная лента FLASH 50 m



|                        |                     |           |          |       |      |      |      |   |  |  |
|------------------------|---------------------|-----------|----------|-------|------|------|------|---|--|--|
|                        |                     |           |          |       |      |      |      |   |  |  |
| LD-3528-300-20-ZB-50   | 12 VDC<br>4,8 W/m   | 300 lm/m  | ● 6500 K | 20    | 120° | 8 mm | 60/m | 5 |  |  |
| LD-3528-300-20-NE4P-50 |                     |           | ● 4000 K |       |      |      |      |   |  |  |
| LD-3528-300-20-CB-50   |                     |           | ● 3200 K |       |      |      |      |   |  |  |
| LD-3528-600-20-ZB-50   | 12 VDC<br>9,6 W/1 m | 550 lm/m  | ● 6500 K |       |      |      |      |   |  |  |
| LD-3528-600-20-NE4-50  |                     |           | ● 4000 K |       |      |      |      |   |  |  |
| LD-3528-600-20-CB-50   |                     |           | ● 3200 K |       |      |      |      |   |  |  |
| LD-2835-300-20-ZB-50   | 12 VDC<br>6 W/m     | 750 lm/m  | ● 6500 K |       |      |      |      |   |  |  |
| LD-2835-300-20-NE4P-50 |                     |           | ● 4000 K |       |      |      |      |   |  |  |
| LD-2835-300-20-CB-50   |                     |           | ● 3200 K |       |      |      |      |   |  |  |
| LD-5050-300-20-NE4-50  | 12DC<br>14,4W/m     | 900 lm/m  | ● 4000 K | 10 mm | 60/m |      |      |   |  |  |
| LD-5630-300-20-NE4-50  | 12DC<br>16W/m       | 1750 lm/m | ● 4000 K |       |      |      |      |   |  |  |



ТаЅма LED FLASH  
LED strip FLASH  
Светодиодная лента FLASH









|                        |                                 |           |          |    |      |      |      |    |  |  |
|------------------------|---------------------------------|-----------|----------|----|------|------|------|----|--|--|
|                        |                                 |           |          |    |      |      |      |    |  |  |
| LD-2835-24V-300-20-ZB  | 24 V DC<br>12 W/1 m<br>48 W/5 m | 750 lm/m  | ● 6500 K | 20 | 120° | 8 mm | 60/m | 10 |  |  |
| LD-2835-24V-300-20-NE4 |                                 |           | ● 4000 K |    |      |      |      |    |  |  |
| LD-2835-24V-300-20-CB  |                                 |           | ● 3200 K |    |      |      |      |    |  |  |
| LD-2835-24V-600-20-ZB  | 24 V DC<br>21 W/1 m<br>78 W/5 m | 1350 lm/m | ● 6500 K |    |      |      |      |    |  |  |
| LD-2835-24V-600-20-NE4 |                                 |           | ● 4000 K |    |      |      |      |    |  |  |
| LD-2835-24V-600-20-CB  |                                 |           | ● 3200 K |    |      |      |      |    |  |  |

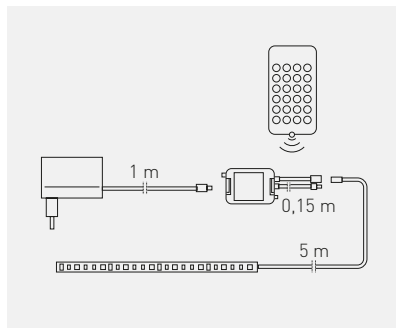



Zestaw RGB, taśma LED 5 m, kontroler, zasilacz, pilot  
 RGB-set, LED band 5 m, RGB controller, LED-transformator, remote control  
 Комплект RGB, лента LED 5 м, контролер, трансформатор, пульт



|   |   |   |   |   |   |
|---|---|---|---|---|---|
|  |  |  |  |  |  |
| LD-ZL5RGB150-00   | 12V   | RGB   | tworzywo, plastic, пластик  | 10  | 10  |



TaЅma LED COB  
LED strip COB  
Светодиодная лента COB

NEW



|                 |                                 |          |          |    |      |      |       |   |
|-----------------|---------------------------------|----------|----------|----|------|------|-------|---|
|                 |                                 |          |          |    |      |      |       |   |
| LD-COB12V-20-ZB | 12 VDC<br>8,5 W/1 m<br>23 W/5 m | 800 lm/m | ● 5500 K | 20 | 180° | 8 mm | 320/m | 5 |
| LD-COB12V-20-NE |                                 |          | ● 4000 K |    |      |      |       |   |
| LD-COB12V-20-CB |                                 |          | ● 3200 K |    |      |      |       |   |



Taśma LED NEON FLEX  
LED strip NEON FLEX  
Светодиодная лента NEON FLEX



|                     |                                  |          |          |    |      |      |       |   |
|---------------------|----------------------------------|----------|----------|----|------|------|-------|---|
|                     |                                  |          |          |    |      |      |       |   |
| LD-NF-12V6x12-65-ZB | 12 VDC<br>12 W/1 m<br>40 W/5 m   | 200 lm/m | ● 6500 K | 65 | 120° | 6 mm | 120/m | 1 |
| LD-NF-12V6x12-65-NE |                                  |          | ● 4000 K |    |      |      |       |   |
| LD-NF-12V6x12-65-CB |                                  |          | ● 3000 K |    |      |      |       |   |
|                     |                                  |          |          |    |      |      |       |   |
| LD-ZASNF-12V6X12-65 | zaślepka, end cap, заглушка      |          |          |    |      |      |       |   |
| LD-UNF-12V6X12-6X   | uchwyt, mounting clip, держатель |          |          |    |      |      |       |   |



LD-ZASNF-12V6X12-65



LD-UNF-12V6X12-6X

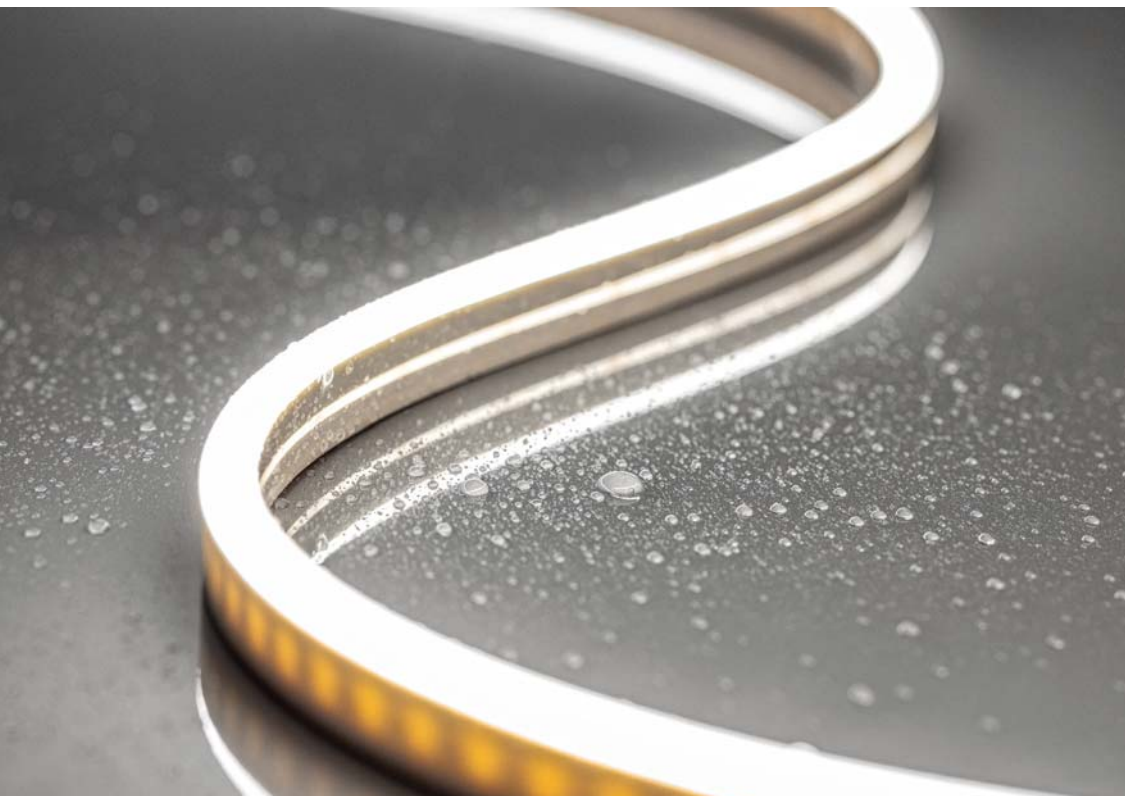

Profil GLAX liniowy  
GLAX linear profile  
Профиль GLAX линейный

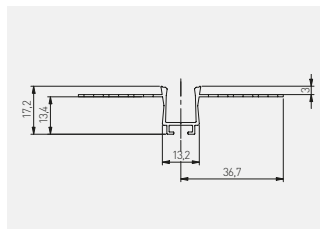
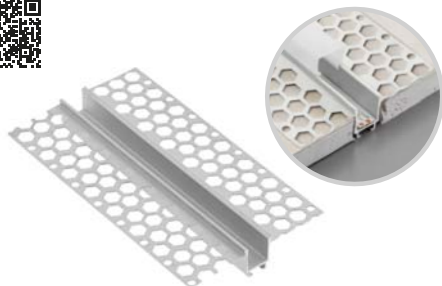

| PA-GLAXGKL3M-00C   | 3 | profil / profile / профиль  | srebrny<br>silver<br>серебристый | aluminium<br>aluminium<br>алюминий                         |
|--------------------|---|---|----------------------------------|--|
| PA-CPGLAXL-00      | - | łącznik liniowy<br>connector straight<br>лінійний з'єднувач         |                                  | stal nierdzewna<br>stainless steel<br>нержавеющая<br>сталь |
| PA-CPGLAXAH-00     | - | łącznik poziomy<br>connector horizontal<br>горизонтальний з'єднувач |                                  |  |
| PA-CPGLAXAV-00     | - | łącznik pionowy<br>connector vertical<br>вертикальний з'єднувач     |                                  |  |
| PA-OSMLGLAXM3M-00  | 3 | ostonka / cover / крышка  | mleczna<br>frosted<br>молочная   | PC   |
| PA-OSMLGLAXMK3M-00 | 3 | ostonka kwadratowa<br>cover square<br>крышка квадратная             |                                  |  |
| PA-OSMLGLAXM03M-00 | 3 | ostonka okrągła<br>cover round<br>крышка круглая                    |                                  |  |
| PA-OSMLGLAXT3M-00  | 3 | ostonka trójkątna<br>cover triangular<br>крышка треугольная         |                                  |  |

Ostonki / Covers / Крышки



Aksesoria / Accessories / Аксессуары



PA-CPGLAXL-00 PA-CPGLAXAH-00 PA-CPGLAXAV-00

PA-OSMLGLAXM3M-00 PA-OSMLGLAXMK3M-00 PA-OSMLGLAXM03M-00 PA-OSMLGLAXT3M-00





Profil GLAX ścienny  
GLAX wall profile  
Профиль GLAX настенный

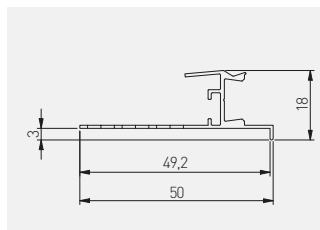
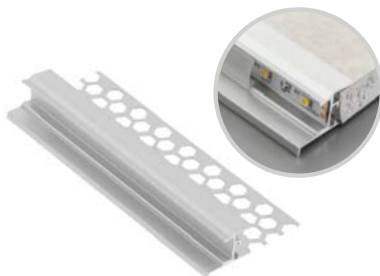

| PA-GLAXGKS3M-00C   | 3 | profil / profile / профиль  | srebrny<br>silver<br>серебристый | aluminium<br>aluminium<br>алюминий                         |
|--------------------|---|---|----------------------------------|--|
| PA-CPGLAXL-00      | - | łącznik liniowy<br>connector straight<br>лінійний з'єднувач         |                                  | stal nierdzewna<br>stainless steel<br>нержавеющая<br>сталь |
| PA-CPGLAXAH-00     | - | łącznik poziomy<br>connector horizontal<br>горизонтальный з'єднувач |                                  |  |
| PA-CPGLAXAV-00     | - | łącznik pionowy<br>connector vertical<br>вертикальний з'єднувач     |                                  |  |
| PA-OSMLGLAXM3M-00  | 3 | ostonka / cover / крышка  | mleczna<br>frosted<br>молочная   | PC   |
| PA-OSMLGLAXMK3M-00 | 3 | ostonka kwadratowa<br>cover square<br>крышка квадратная             |                                  |  |
| PA-OSMLGLAXM03M-00 | 3 | ostonka okrągła<br>cover round<br>крышка круглая.                   |                                  |  |
| PA-OSMLGLAXT3M-00  | 3 | ostonka trójkątna<br>cover triangular<br>крышка треугольная         |                                  |  |

Ostonki / Covers / Крышки



PA-OSMLGLAXM3M-00 PA-OSMLGLAXMK3M-00 PA-OSMLGLAXM03M-00 PA-OSMLGLAXT3M-00

Akcesoria / Accessories / Аксессуары



PA-CPGLAXL-00 PA-CPGLAXAH-00 PA-CPGLAXAV-00



DO  
*something*  
(today)  
THAT YOUR  
FUTURE SELF  
WILL  
THANK YOU  
for

BE  
BRAVE

the  
time  
is  
now.

Better  
days are  
coming.  
They're  
called  
Saturday and  
Sunday.

Smile  
you  
are  
beaut-  
iful.

DO  
WHAT  
YOU  
LOVE

Al  
you  
is  
BRA

Profil GLAX sufitowy  
 GLAX ceiling profile  
 Профиль GLAX потолочный

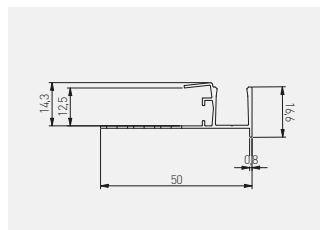
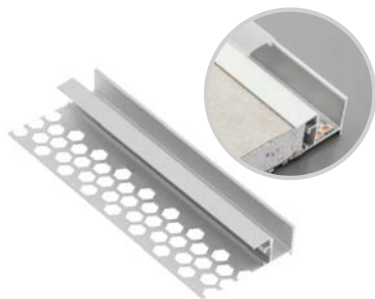

|  |  m |  |  |  |
|---|---|---|---|---|
| PA-GLAXGKW3M-00C  | 3   | profil / profile / профиль  | srebrny<br>silver<br>серебристый  | aluminium<br>aluminium<br>алюминий  |
| PA-CPGLAXL-00   | -   | łącznik liniowy<br>connector straight<br>лінійний з'єднувач                       |   | stal nierdzewna<br>stainless steel<br>нержавеющая сталь                           |
| PA-CPGLAXAH-00  | -   | łącznik poziomy<br>connector horizontal<br>горизонтальний з'єднувач               |   |   |
| PA-CPGLAXAV-00  | -   | łącznik pionowy<br>connector vertical<br>вертикальний з'єднувач                   |   |   |
| PA-OSMLGLAXM3M-00   | 3   | osłonka / cover / крышка  | mleczna<br>frosted<br>молочная  | PC  |
| PA-OSMLGLAXMK3M-00  | 3   | osłonka kwadratowa<br>cover square<br>крышка квадратная                           |   |   |
| PA-OSMLGLAXM03M-00  | 3   | osłonka okrągła<br>cover round<br>крышка круглая                                  |   |   |
| PA-OSMLGLAXT3M-00   | 3   | osłonka trójkątna<br>cover triangular<br>крышка треугольная                       |   |   |

Osłonki / Covers / Крышки



PA-OSMLGLAXM3M-00 PA-OSMLGLAXMK3M-00 PA-OSMLGLAXM03M-00 PA-OSMLGLAXT3M-00

Akcesoria / Accessories / Аксессуары



PA-CPGLAXL-00 PA-CPGLAXAH-00 PA-CPGLAXAV-00





Profil GLAX kątowy, wewnętrzny  
 GLAX internal angle profile  
 Профиль GLAX угловой внутренний

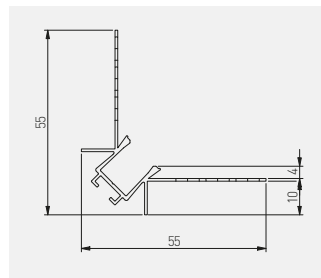

|                    |   |   |                                  |                                    |
|--------------------|---|---|----------------------------------|------------------------------------|
| PA-GLAXGKWK3M-00C  | 3 | profil / profile / профиль  | srebrny<br>silver<br>серебристый | aluminium<br>aluminium<br>алюминий |
| PA-CPGLAXL-00      | - | łącznik liniowy<br>connector straight<br>лінійний з'єднувач         |                                  |                                    |
| PA-CPGLAXAH-00     | - | łącznik poziomy<br>connector horizontal<br>горизонтальний з'єднувач |                                  |                                    |
| PA-CPGLAXAV-00     | - | łącznik pionowy<br>connector vertical<br>вертикальний з'єднувач     |                                  |                                    |
| PA-OSMLGLAXM3M-00  | 3 | ostonka / cover / крышка  | mleczna<br>frosted<br>молочная   | PC                                 |
| PA-OSMLGLAXMK3M-00 | 3 | ostonka kwadratowa<br>cover square<br>крышка квадратная             |                                  |                                    |
| PA-OSMLGLAXM03M-00 | 3 | ostonka okrągła<br>cover round<br>крышка круглая                    |                                  |                                    |
| PA-OSMLGLAXT3M-00  | 3 | ostonka trójkątna<br>cover triangular<br>крышка треугольная         |                                  |                                    |

Ostonki / Covers / Крышки



Akcesoria / Accessories / Аксессуары



PA-CPGLAXL-00 PA-CPGLAXAH-00 PA-CPGLAXAV-00

PA-OSMLGLAXM3M-00 PA-OSMLGLAXMK3M-00 PA-OSMLGLAXM03M-00 PA-OSMLGLAXT3M-00



Profil GLAX kątowy, zewnętrzny  
 GLAX external angle profile  
 Профиль GLAX угловой внешний

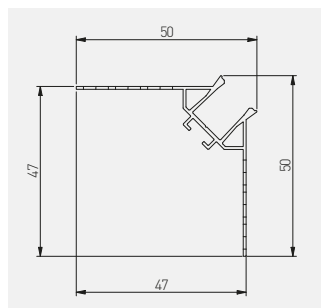
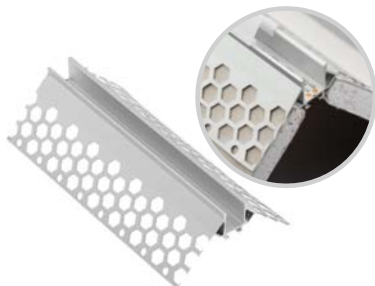

|                    | L<br>m |   |                                  |  |
|--------------------|--------|---|----------------------------------|--|
| PA-GLAXGKZK3M-00C  | 3      | profil / profile / профиль  | srebrny<br>silver<br>серебристый | aluminium<br>aluminium<br>алюминий                         |
| PA-CPGLAXL-00      | -      | łącznik liniowy<br>connector straight<br>лінійний з'єднувач         |                                  | stal nierdzewna<br>stainless steel<br>нержавеющая<br>сталь |
| PA-CPGLAXAH-00     | -      | łącznik poziomy<br>connector horizontal<br>горизонтальный з'єднувач |                                  |  |
| PA-CPGLAXAV-00     | -      | łącznik pionowy<br>connector vertical<br>вертикальний з'єднувач     |                                  |  |
| PA-OSMLGLAXM3M-00  | 3      | ostonka / cover / крышка  | mleczna<br>frosted<br>молочная   | PC   |
| PA-OSMLGLAXMK3M-00 | 3      | ostonka kwadratowa<br>cover square<br>крышка квадратная             |                                  |  |
| PA-OSMLGLAXM03M-00 | 3      | ostonka okrągła<br>cover round<br>крышка круглая                    |                                  |  |
| PA-OSMLGLAXT3M-00  | 3      | ostonka trójkątna<br>cover triangular<br>крышка треугольная         |                                  |  |

Ostonki / Covers / Крышки



Akcesoria / Accessories / Аксессуары



PA-CPGLAXL-00 PA-CPGLAXAH-00 PA-CPGLAXAV-00

PA-OSMLGLAXM3M-00 PA-OSMLGLAXMK3M-00 PA-OSMLGLAXM03M-00 PA-OSMLGLAXT3M-00

Profil GLAX nakładany, mikro  
 GLAX profile surface mounted, micro  
 Профиль GLAX накладной, микро

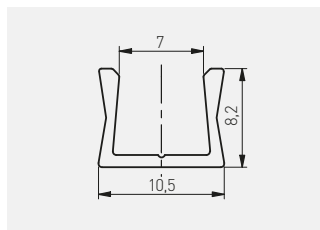
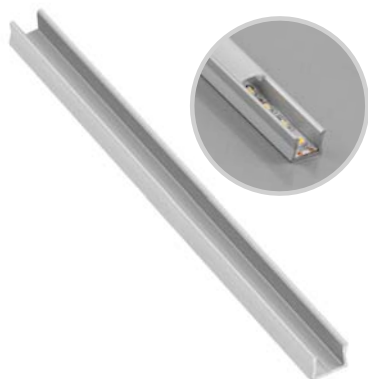

Wąska linia światła.  
 Brak punktów świetlnych przy użyciu  
 dedykowanej taśmy LED o szerokości 5 mm.  
 Narrow line of light.  
 No visible points of light due to dedicated  
 5mm LED strip.  
 Узкая линия света.  
 Отсутствуют пункты свечения при  
 использовании специальной ленты LED  
 с шириной 5 мм.

|  |  |  |  |  |
|---|---|---|---|---|
| PA-GLAXMICNK-AL   | 2   | profil<br>profile<br>профиль  | srebrny<br>silver<br>серебристый  | aluminium<br>aluminium<br>алюминий  |
| PA-GLAXMICNK3M-AL   | 3   |   |   |   |
| PA-OSMLGLAXMIC-00N  | 2   | ostonka mikro<br>cover micro<br>крышка микро                                      | mleczna<br>frosted<br>молочная  | PC  |
| PA-OSMLGLAXMIC3M-00N  | 3   |   |   |   |
| PA-ZASGLAXMICNK-00  | -   | zaślepka<br>end cap<br>заглушка   | szary<br>gray<br>серый  | ABS   |
| PA-SPRGLAXMIC-00  | -   | uchwył<br>mounting clip<br>держатель  | srebrny<br>silver<br>серебристый  | stal nierdzewna<br>stainless steel<br>нержавеющая сталь                           |



Profil GLAX nakładany mini  
GLAX profile mini surface mounted  
Профиль GLAX накладной мини

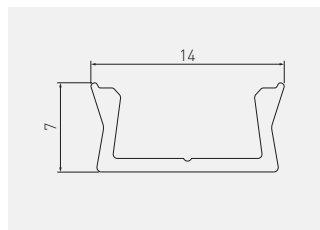
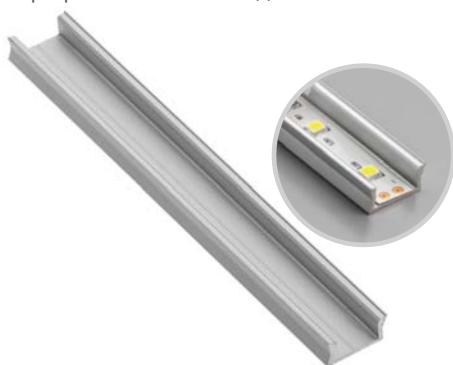

Taśma LED max. 10 mm szerokości  
LED strip width max 10 mm  
Ширина светодиодной ленты не более 10 мм



|                     |   |   |   |   |     |
|---------------------|---|---|---|---|-----|
| PA-GLAXMNK-AL       | 2 | profil<br>profile<br>профиль                                  | srebrny / silver / серебристый              | aluminium<br>aluminium<br>алюминий                      |     |
| PA-GLAXMNK-AL-20M   |   |   | czarny / black / черный                     |   |     |
| PA-GLAXMNK-AL-10    |   |   | biały / white / белый                       |   |     |
| PA-GLAXMNK-AL-90    |   |   | szampan / champagne / шампань               |   |     |
| PA-GLAXMNK3M-AL     |   |   | srebrny / silver / серебристый              |   |     |
| PA-GLAXMNK3M-AL-20M | 3 | ostonka mini<br>cover mini<br>крышка мини                     | mleczna / frosted / молочная                | PC  |     |
| PA-GLAXMNK3M-AL-10  |   |   | transparentna / transparent<br>прозрачная   |   |     |
| PA-OSMLGLAXM-00     | 2 | ostonka kwadratowa<br>cover square<br>крышка квадратная       | mleczna / frosted / молочная                |   | ABS |
| PA-OSMLGLAXM3M-00   | 3 |   |   |   |     |
| PA-OSTRGLAXM-00     | 2 | ostonka okrągła<br>cover round<br>крышка круглая              | mleczna / frosted / молочная                |   |     |
| PA-OSTRGLAXM3M-00   | 3 |   |   |   |     |
| PA-OSMLGLAXMK-00    | 2 | zaślepka standard<br>end cap standard<br>заглушка стандартная | szary / gray / серый                        | stal nierdzewna<br>stainless steel<br>нержавеющая сталь |     |
| PA-ZASGLAXM3M-00    |   |   | biały / white / белый                       |   |     |
| PA-ZASGLAXM3M-90    | - | zaślepka kwadratowa<br>end cap square<br>заглушка квадратная  | szampan / champagne / шампань               |   |     |
| PA-ZASGLAXM3M-20M   |   |   | czarny mat / black matt /<br>чёрный матовый |   |     |
| PA-ZASGLAXM3M-00    | - | zaślepka okrągła<br>end cap round<br>заглушка круглая         | szary / gray / серый                        |   |     |
| PA-SPRGLAXM-00      | - | uchwyt<br>mounting clip<br>держатель                          | srebrny / silver / серебристый              |   |     |

Ostonki / Covers / Крышки

Zaślepki / End caps / Заглушки



PA-OSMLGLAXM-00  
PA-OSMLGLAXM3M-00

PA-OSTRGLAXM-00  
PA-OSTRGLAXM3M-00

PA-OSMLGLAXM0-00  
PA-OSMLGLAXMK-00

PA-ZASGLAXM3M-00

PA-ZASGLAXM3M-90  
Uchwyt  
mounting clip  
держатель

PA-ZASGLAXM3M-20M

PA-SPRGLAXM-00

Profil GLAX nakładny  
GLAX profile surface mounted  
Профиль GLAX накладной

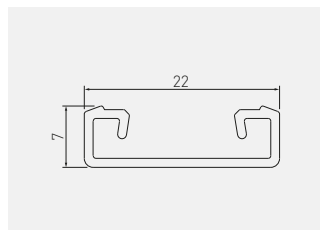

| PA-GLAXNK-AL     | 2 | profil<br>profile<br>профиль              | srebrny<br>silver<br>серебристый           | aluminium<br>aluminium<br>алюминий |
|------------------|---|---|--|------------------------------------|
| PA-GLAXNK3M-AL   | 3 |   |  |                                    |
| PA-OSMLGLAX-00   | 2 | ostonka mini<br>cover mini<br>крышка мини | mleczna<br>frosted<br>молочная             | PC                                 |
| PA-OSMLGLAX3M-00 | 3 |   |  |                                    |
| PA-OSTRGLAX-00   | 2 |   | transparentna<br>transparent<br>прозрачная |                                    |
| PA-OSTRGLAX3M-00 | 3 |   |  |                                    |
| PA-ZASGLAXNK-00  | - | zaślepka<br>end cap<br>заглушка           | szary<br>gray<br>серый                     | ABS                                |



Profil GLAX nakładany mini, wysoki  
 Profile GLAX surface mounted mini, high  
 Профиль GLAX накладной мини, высокий

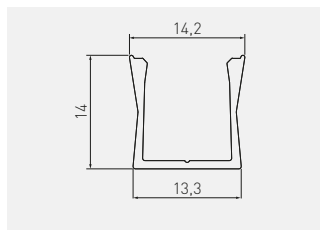

Brak widocznych punktów świetlnych.  
 Taśma LED max 10 mm szerokości.  
 No visible points of light.  
 LED strip width max 10 mm.  
 Нет видимых точек света.  
 Ширина светодиодной ленты не более 10 мм.



|                    |   |   |   |   |
|--------------------|---|---|---|---|
| PA-GLAXMKNK-AL     | 2 | profil<br>profile<br>профиль              | srebrny / silver / серебристый              | aluminium<br>aluminium<br>алюминий                      |
| PA-GLAXMKNK-AL-20M |   |   | czarny / black / черный                     |   |
| PA-GLAXMKNK-AL-10  |   |   | biały / white / белый                       |   |
| PA-GLAXMKNK-AL-90  |   |   | szampa / champagne / шампань                |   |
| PA-OSMLGLAXM-00    | 2 | ostonka mini<br>cover mini<br>крышка мини | mleczna / frosted / молочная                | PC  |
| PA-OSTRGLAXM-00    |   |   | transparentna / transparent / прозрачная    |   |
| PA-ZASGLAXMKNK-00  | - | zaślepka<br>end cap<br>заглушка           | szary / gray / серый                        | ABS   |
| PA-ZASGLAXMKNK-10  |   |   | biały / white / белый                       |   |
| PA-ZASGLAXMKNK-90  |   |   | szampa / champagne / шампань                |   |
| PA-ZASGLAXMKNK-20M |   |   | czarny mat / black matt /<br>чёрный матовый |   |
| PA-SPRGLAXM-00     | - | uchwyt<br>mounting clip<br>держатель      | srebrny / silver / серебристый              | stal nierdzewna<br>stainless steel<br>нержавеющая сталь |

Ostonki / Covers / Крышки

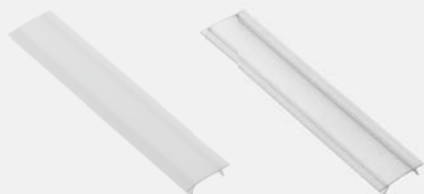

PA-OSMLGLAXM-00

PA-OSTRGLAXM-00

Zaślepka / End cap / Заглушка



PA-ZASGLAXMKNK-00

 Uchwyt  
Mounting clip  
держатель

PA-SPRGLAXM-00



Profil GLAX wpuszczany, mikro  
GLAX profile recessed, micro  
Профиль GLAX врезной, микро

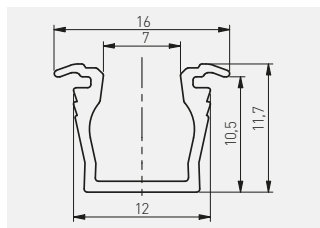

Wąska linia światła.  
Brak punktów świetlnych przy użyciu dedykowanej taśmy LED o szerokości 5 mm.  
Narrow line of light.  
No visible points of light due to dedicated 5 mm LED strip.  
Узкая линия света.  
Отсутствуют пункты свечения при использовании специальной ленты LED с шириной 5 мм.



|                      |   |  |                                  |                                    |
|----------------------|---|--|----------------------------------|------------------------------------|
| PA-GLAXMIC-AL        | 2 | profil<br>profile<br>профиль                 | srebrny<br>silver<br>серебристый | aluminium<br>aluminium<br>алюминий |
| PA-GLAXMIC3M-AL      | 3 |  |                                  |                                    |
| PA-OSMLGLAXMIC-00N   | 2 | ostonka mikro<br>cover micro<br>крышка микро | mleczna<br>frosted<br>молочная   | PC                                 |
| PA-OSMLGLAXMIC3M-00N | 3 |  |                                  |                                    |
| PA-ZASGLAXMIC-00     | - | zaślepka<br>end cap<br>заглушка              | szary<br>gray<br>серый           | ABS                                |

Ostonki / Covers / Крышки



PA-OSMLGLAXMIC-00N  
PA-OSMLGLAXMIC3M-00N

Zaślepka / End cap / Заглушка



PA-ZASGLAXMIC-00

Profil GLAX wpuszczany  
Profile GLAX recessed  
Профиль LED GLAX врезной

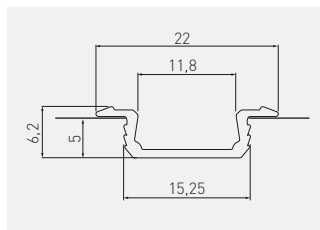

| PA-GLAX-AL       | 2 | profil<br>profile<br>профиль    | srebrny / silver / серебристый              | aluminium<br>aluminium<br>алюминий |
|------------------|---|---------------------------------|---|------------------------------------|
| PA-GLAX-AL-20M   |   |                                 | czarny / black / черный                     |                                    |
| PA-GLAX-AL-10    |   |                                 | biały / white / белый                       |                                    |
| PA-GLAX-AL-90    |   |                                 | szampan / champagne / шампань               |                                    |
| PA-GLAX3M-AL     |   |                                 | srebrny / silver / серебристый              |                                    |
| PA-GLAX3M-AL-20M | 3 |                                 | czarny / black / черный                     |                                    |
| PA-GLAX3M-AL-10  |   |                                 | biały / white / белый                       |                                    |
| PA-OSMLGLAX-00   | 2 | ostonka<br>cover<br>крышка      | mleczna<br>frosted<br>молочная              | PC                                 |
| PA-OSMLGLAX3M-00 | 3 |                                 | transparentna<br>transparent<br>прозрачная  |                                    |
| PA-OSTRGLAX-00   | 2 |                                 |   |                                    |
| PA-OSTRGLAX3M-00 | 3 |                                 |   |                                    |
| PA-ZASGLAX-00    | - | zaślepka<br>end cap<br>заглушка | szary / gray / серый                        | ABS                                |
| PA-ZASGLAX-10    |   |                                 | biały / white / белый                       |                                    |
| PA-ZASGLAX-90    |   |                                 | szampan / champagne / шампань               |                                    |
| PA-ZASGLAX-20M   |   |                                 | czarny mat / black matt /<br>чёрный матовый |                                    |

Ostonki / Covers / Крышки

Zaślepka / End cap / Заглушка



PA-OSMLGLAX-00  
PA-OSMLGLAX3M-00

PA-OSTRGLAX-00  
PA-OSTRGLAX3M-00

PA-ZASGLAX-00

Profil GLAX wpuszczany, wysoki  
 Profile GLAX recessed, high  
 Профиль LED GLAX врезной

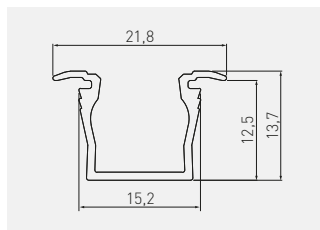

Brak widocznych punktów świetlnych.  
Taśma LED max. 10 mm szerokości.

No visible points of light.  
LED strip width max 10 mm.

Нет видимых точек света.  
Ширина светодиодной ленты  
не более 10 мм.

| PA-GLAXMW-AL     | 2 | profil<br>profile<br>профиль                                     | srebrny / silver / серебристый              | aluminium<br>aluminium<br>алюминий |  |
|------------------|---|--|---|------------------------------------|--|
| PA-GLAXMW-AL-20M |   |  | czarny / black / черный                     |                                    |  |
| PA-GLAXMW-AL-10  |   |  | biały / white / белый                       |                                    |  |
| PA-GLAXMW-AL-90  |   |  | szampan / champagne / шампань               |                                    |  |
| PA-OSMLGLAXM-00  | 2 | osłonka mini<br>cover mini<br>крышка мини                        | mleczna<br>frosted<br>молочная              | PC                                 |  |
| PA-OSMLGLAXMK-00 |   | osłonka kwadratowa<br>cover square<br>крышка квадратная          |   |                                    |  |
| PA-OSTRGLAXM-00  |   | osłonka mini<br>cover mini<br>крышка мини                        | transparentna<br>transparent<br>прозрачная  |                                    |  |
| PA-ZASGLAXMW-00  | - | zaślepka standard<br>end cap standard<br>заглушка<br>стандартная | szary / gray / серый                        | ABS                                |  |
| PA-ZASGLAXMW-10  |   |  | biały / white / белый                       |                                    |  |
| PA-ZASGLAXMW-90  |   |  | szampan / champagne / шампань               |                                    |  |
| PA-ZASGLAXMW-20M |   |  | czarny mat / black matt /<br>чёрный матовый |                                    |  |
| PA-ZASGLAXMWK-00 | - | zaślepka kwadratowa<br>end cap square<br>заглушка квадратная     | szary / gray / серый                        |                                    |  |

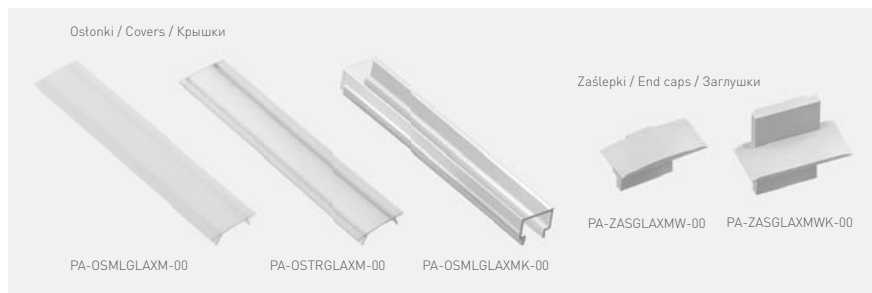

Profil GLAX drążkowy  
GLAX rail profile  
Профиль-штанга GLAX

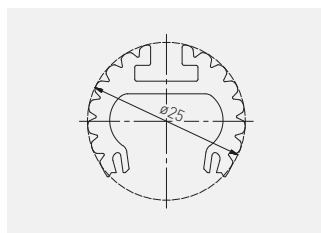

Możliwości montażu jako:

Assembly options as:

Варианты сборки:

- drążek w szafie
- oprawa zwieszana
- rod in the closet
- suspended luminaire
- стержень в шкафу
- подвесной светильник

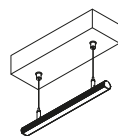
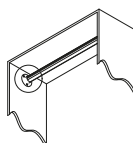

|                 |     |  |  |                                    |
|-----------------|-----|--|--|------------------------------------|
| PA-GLAXDR-AL    | 2   | profil<br>profile<br>профиль                                       | srebrny<br>silver<br>серебристый           | aluminium<br>aluminium<br>алюминий |
| PA-OSMLGLAX-00  |     | ostonka<br>cover<br>крышка   | mleczna<br>frosted<br>молочная             | PC                                 |
| PA-OSTRGLAX-00  |     |  | transparentna<br>transparent<br>прозрачная |                                    |
| PA-ZASGLAXDR-00 | -   | zaślepka<br>end cap<br>заглушка                                    | szary<br>gray<br>серый                     | ABS                                |
| PA-ROZGLAX-53   | -   | rozetka<br>rail socket<br>монтажный крепеж                         |  | ZnAl                               |
| PA-ROZGLAXP-53  | -   | rozetka PREMIUM<br>rail socket PREMIUM<br>монтажный крепеж PREMIUM |  |                                    |
| PA-ZAWGLAXDR-00 | 1,5 | zawieszka<br>hanger<br>подвес для профиля                          | chrom<br>chrome<br>хром                    | stal<br>steel<br>сталь             |

Ostonki / Covers / Крышки

Zaślepka / End cap /  
Заглушка

Rozetka / Rail socket /  
Монтажный крепеж

Zawieszka / Hanger /  
Подвес для профиля



PA-OSMLGLAX-00

PA-OSTRGLAX-00

PA-ZASGLAXDR-00

PA-ROZGLAX-53

PA-ROZGLAXP-53

PA-ZAWGLAXDR-00

Profil GLAX z radiatorem  
 Profile GLAX with heatsink  
 Профиль GLAX с радиатором

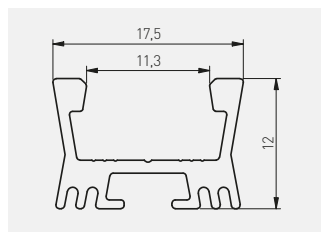

Dedykowana soczewka zawężająca kąt świecenia do 60°.

Możliwość zawieszenia oprawy za pomocą linek.  
Dedicated lens that narrow the beam angle to 60°.  
Possibility to suspend the fixture using lines.

Специальная линза, сужающая угол свечения до 60°.

Возможность монтажа с помощью крепления-тросика.

| PA-GLAXRAD-AL    | 2   | profil / profile / профиль                                 | srebrny<br>silver<br>серебристый           | aluminium<br>aluminium<br>алюминий                      |  |
|------------------|-----|--|--|---|--|
| PA-OSMLGLAXSO-00 | 2   | ostonka soczewka<br>cover lenticular<br>крышка линзовидный | transparentna<br>transparent<br>прозрачная | PMMA  |  |
| PA-OSMLGLAX-00   | 2   | ostonka<br>cover<br>крышка                                 | mleczna<br>frosted<br>молочная             | PC  |  |
| PA-OSTRGLAX-00   |     |  | transparentna<br>transparent<br>прозрачная |   |  |
| PA-ZASGLAXRAD-00 | -   | zaślepka<br>end cap<br>заглушка                            | szary / gray / серый                       | ABS   |  |
| PA-ZAWGLAXDR-00  | 1,5 | zawieszka<br>hanger<br>подвес для профиля                  | chrom<br>chrome<br>хром                    | stal nierdzewna<br>stainless steel<br>нержавеющая сталь |  |
| PA-SPRGLAXM-00   | -   | uchwył<br>mounting clip<br>держатель                       | srebrny / silver / серебристый             |   |  |



Profil GLAX wieńcowy  
Rim profile GLAX  
Профиль GLAX, торцевой

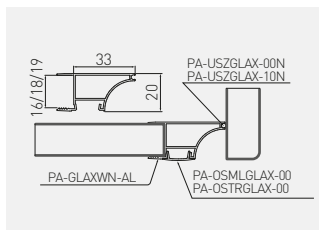

|                    |    |    |   |  |                                      |
|--------------------|----|----|---|--|--------------------------------------|
| PA-GLAXWN-AL       | 18 | 2  | profil<br>profile<br>профиль            | srebrny, silver, серебристый           | aluminium,<br>aluminium,<br>алюминий |
| PA-GLAXWN3M-AL     |    | 3  |   | czarny, black, черный                  |                                      |
| PA-GLAXWN3M-AL-20M |    |    |   | biaty, white, белый                    |                                      |
| PA-GLAXWN3M-AL-10  |    |    |   | inox, inox, шлифованная сталь.         |                                      |
| PA-GLAXWN3M-AL-06  |    |    |   | 2                                      |                                      |
| PA-GLAXWN16-AL     | 16 | 2  | profil<br>profile<br>профиль            | srebrny, silver, серебристый           | aluminium,<br>aluminium,<br>алюминий |
| PA-GLAXWN19-AL     | 19 |    |   |  |                                      |
| PA-OSMLGLAX-00     | -  | 2  | ostonka<br>cover<br>крышка              | mleczna, frosted, молочная             | PC                                   |
| PA-OSTRGLAX-00     | -  |    |   | transparentna, transparent, прозрачная |                                      |
| PA-OSMLGLAX3M-00   | -  | 3  | ostonka<br>cover<br>крышка              | mleczna, frosted, молочная             |                                      |
| PA-OSTRGLAX3M-00   | -  |    |   | transparentna, transparent, прозрачная |                                      |
| PA-USZGLAX-00N     | -  | 10 | uszczelka<br>cord gasket<br>уплотнитель | czarny, black, черный                  | EPDM                                 |
| PA-USZGLAX-10N     | -  |    |   | biaty, white, белый                    |                                      |

Ostonki / Covers / Крышки

Uszczelka / Cord gasket / Уплотнитель



PA-OSMLGLAX-00



PA-OSTRGLAX-00



ø2,5

PA-USZGLAX-00N



ø2,5

PA-USZGLAX-10N

Profil GLAX kątowy, nakładany  
 GLAX aluminium corner profile – surface mounted  
 Профиль LED GLAX угловой, накладной

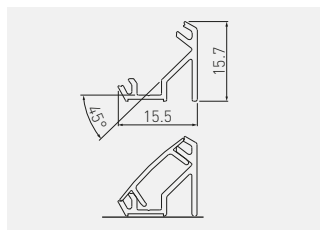

| PA-GLAXNKKT-AL       | 2 | m   | profil<br>profile<br>профиль                                     | srebrny / silver / серебристый              | aluminium<br>aluminium<br>алюминий                      |
|----------------------|---|---|--|---|---|
| PA-GLAXNKKT-AL-20M   |   |   |  | czarny / black / черный                     |   |
| PA-GLAXNKKT-AL-10    |   |   |  | biały / white / белый                       |   |
| PA-GLAXNKKT-AL-90    |   |   |  | szampan / champagne / шампань               |   |
| PA-GLAXNKKT3M-AL     |   |   |  | srebrny / silver / серебристый              |   |
| PA-GLAXNKKT3M-AL-20M |   |   |  | czarny / black / черный                     |   |
| PA-GLAXNKKT3M-AL-10  | 3 |   |  | biały / white / белый                       |   |
| PA-OSMLGLAX-00       | 2 | ostonka<br>cover<br>крышка                                  |  | mleczna<br>frosted<br>молочная              | PC  |
| PA-OSMLGLAX3M-00     | 3 |   |  | transparentna<br>transparent<br>прозрачная  |   |
| PA-OSTRGLAX-00       | 2 |   |  |   |   |
| PA-OSTRGLAX3M-00     | 3 |   |  |   |   |
| PA-OSMLGLAXT-00      | 2 | ostonka trójkątna<br>cover triangular<br>крышка треугольная |  | mleczna<br>frosted<br>молочная              |   |
| PA-ZASGLAXNKKT-00    | - |   | zaślepka standard<br>end cap standard<br>заглушка стандартная    | szary / gray / серый                        | ABS   |
| PA-ZASGLAXNKKT-10    |   |   |  | biały / white / белый                       |   |
| PA-ZASGLAXNKKT-90    |   |   |  | szampan / champagne / шампань               |   |
| PA-ZASGLAXNKKT-20M   |   |   |  | czarny mat / black matt /<br>чёрный матовый |   |
| PA-ZASGLAXNKKTT-00   |   |   | zaślepka trójkątna<br>end cap triangular<br>заглушка треугольная | szary / gray / серый                        |   |
| PA-SPRGLAXMIC-00     | - |   | uchwyty<br>mounting clip<br>держатель                            | srebrny / silver / серебристый              | stal nierdzewna<br>stainless steel<br>нержавеющая сталь |

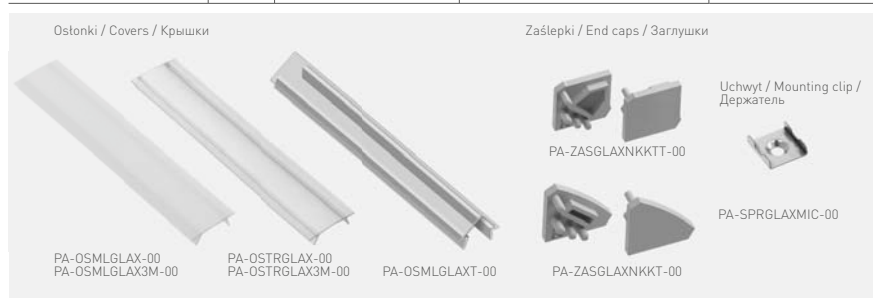

Profil GLAX cokołowy wąski, jednostronny  
 Corner profile GLAX, one-sided, edge mounted  
 Профиль GLAX торцевой, узкий, накладной, односторонний

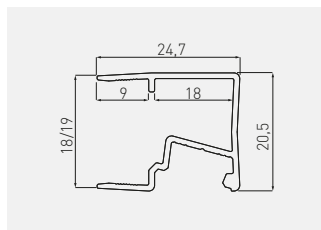

| PA-GLAXMNB JW3M-AL   | 18 | 3 | profil<br>profile<br>профиль              | srebrny<br>silver<br>серебристый           | aluminium<br>aluminium<br>алюминий |
|----------------------|----|---|---|--|------------------------------------|
| PA-GLAXMNB JW3M19-AL | 19 |   |   |  |                                    |
| PA-OSMLGLAXM3M-00    | -  |   | osłonka mini<br>cover mini<br>крышка мини | mleczna<br>frosted<br>молочная             | PC                                 |
| PA-OSTRGLAXM3M-00    | -  |   |   | transparentna<br>transparent<br>прозрачная |                                    |

Ostonki / Covers / Крышки



PA-OSMLGLAXM3M-00



PA-OSTRGLAXM3M-00



Profil GLAX cokołowy wąski, dwustronny  
 Corner profile GLAX, two-sided, edge mounted  
 Профиль GLAX торцевой, узкий, накладной, двусторонний

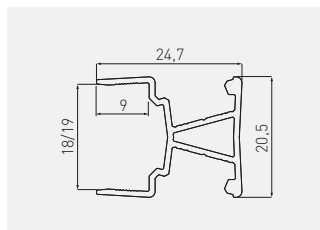
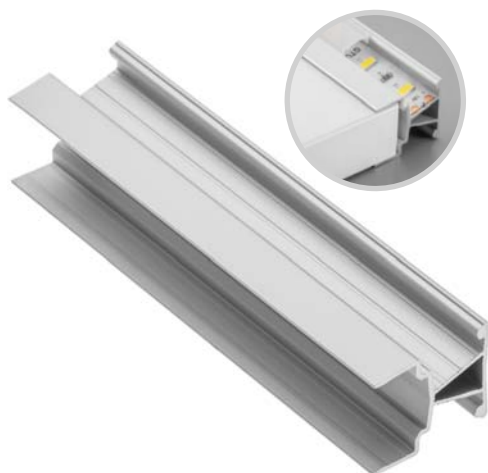

| PA-GLAXMNBW3M-AL   | 18 | 3 | profil<br>profile<br>профиль              | srebrny<br>silver<br>серебристый           | aluminium<br>aluminium<br>алюминий |
|--------------------|----|---|---|--|------------------------------------|
| PA-GLAXMNBW3M19-AL | 19 |   |   |  |                                    |
| PA-OSMLGLAXM3M-00  | -  |   | ostonka mini<br>cover mini<br>крышка мини | mleczna<br>frosted<br>молочная             | PC                                 |
| PA-OSTRGLAXM3M-00  | -  |   |   | transparentna<br>transparent<br>прозрачная |                                    |

Ostonki / Covers / Крышки



PA-OSMLGLAXM3M-00



PA-OSTRGLAXM3M-00

Profil GLAX półkowy mini  
Shelf profile GLAX mini  
Профиль GLAX полочный мини

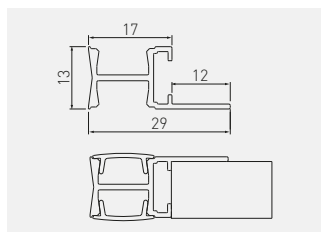

Możliwość zastosowania 3 taśm LED.  
Possibility of using 3 LED strips.  
Возможность использования 3 светодиодных лент.

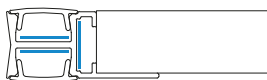

| PA-GLAXMPK-AL   | 2 | profil<br>profile<br>профиль              | srebrny<br>silver<br>серебристый           | aluminium<br>aluminium<br>алюминий |
|-----------------|---|---|--|------------------------------------|
| PA-OSMLGLAXM-00 |   | ostonka mini<br>cover mini<br>крышка мини | mleczna<br>frosted<br>молочная             | PC                                 |
| PA-OSTRGLAXM-00 |   |   | transparentna<br>transparent<br>прозрачная |                                    |

Ostonki / Covers / Крышки



PA-OSMLGLAXM-00



PA-OSTRGLAXM-00

Profil GLAX z regulowanym kątem świecenia  
 Aluminium Profile LED with adjustable angle  
 Профиль LED GLAX с регулировкой угла свечения

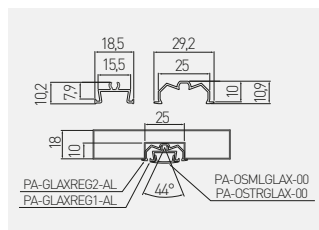

| PA-GLAXREG1-AL | 2 | profil<br>profile<br>профиль | srebrny<br>silver<br>серебристый           | aluminium<br>aluminium<br>алюминий |
|----------------|---|------------------------------|--|------------------------------------|
| PA-GLAXREG2-AL |   |                              |  |                                    |
| PA-OSMLGLAX-00 | 2 | ostonka<br>cover<br>крышка   | mleczna<br>frosted<br>молочная             | PC                                 |
| PA-OSTRGLAX-00 |   |                              | transparentna<br>transparent<br>прозрачная |                                    |



Profil GLAX cokołowy jednostronny  
 GLAX aluminium edge profile – single-sided  
 Профиль LED GLAX торцевой, односторонний

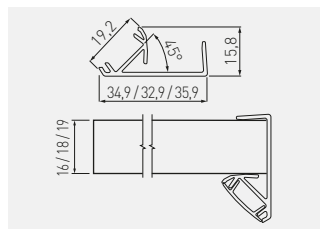

|                  | BOARD<br>mm | L<br>m |                              |  |                                    |
|------------------|-------------|--------|------------------------------|--|------------------------------------|
| PA-GLAXNB3M16-AL | 16          | 3      | profil<br>profile<br>профиль | srebrny<br>silver<br>серебристый           | aluminium<br>aluminium<br>алюминий |
| PA-GLAXNB3M-AL   | 18          | 3      |                              |  |                                    |
| PA-GLAXNB3M19-AL | 19          | 3      |                              |  |                                    |
| PA-OSMLGLAX3M-00 | -           | 3      | oślonka<br>cover<br>крышка   | mleczna<br>frosted<br>молочная             | PC                                 |
| PA-OSTRGLAX3M-00 | -           | 3      |                              | transparentna<br>transparent<br>прозрачная |                                    |

Oślonki / Covers / Крышки



PA-OSMLGLAX3M-00



PA-OSTRGLAX3M-00

Profil GLAX cokołowy jednostronny, do wypełnienia obrzeżem  
 GLAX aluminium edge profile – single-sided, option to fill with matching edge banding  
 Профиль LED GLAX торцевой, односторонний, кромочный, двухсторонний

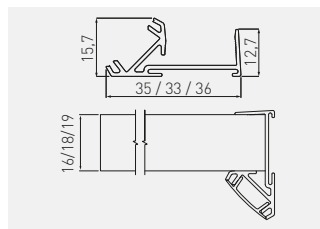

|  |  BOARD<br>mm |  L<br>m |  |  |  |
|---|---|--|---|---|---|
| PA-GLAXNBW3M16-AL   | 16  | 3  | profil<br>profile<br>профиль  | srebrny<br>silver<br>серебристый  | aluminium<br>aluminium<br>алюминий  |
| PA-GLAXNBW3M-AL   | 18  | 3  |   |   |   |
| PA-GLAXNBW3M19-AL   | 19  | 3  |   |   |   |
| PA-OSMLGLAX3M-00  | -   | 3  | ostonka<br>cover<br>крышка  | mleczna<br>frosted<br>молочная  | PC  |
| PA-OSTRGLAX3M-00  | -   | 3  |   | transparentna<br>transparent<br>прозрачная  |   |

Ostonki / Covers / Крышки



PA-OSMLGLAX3M-00



PA-OSTRGLAX3M-00

Profil GLAX przegrodowy dwustronny  
 GLAX aluminium edge profile – double sided  
 Профиль LED GLAX разделительный, двухсторонний

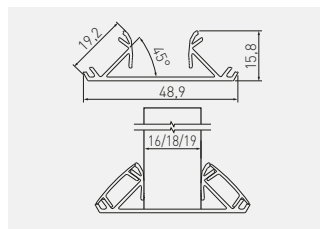

|                   | BOARD<br>mm | L<br>m |                              |  |                                    |
|-------------------|-------------|--------|------------------------------|--|------------------------------------|
| PA-GLAXNBD3M16-AL | 16          | 3      | profil<br>profile<br>профиль | srebrny<br>silver<br>серебристый           | aluminium<br>aluminium<br>алюминий |
| PA-GLAXNBD3M-AL   | 18          | 3      |                              |  |                                    |
| PA-GLAXNBD3M19-AL | 19          | 3      |                              |  |                                    |
| PA-OSMLGLAX3M-00  | -           | 3      | ostonka<br>cover<br>крышка   | mleczna<br>frosted<br>молочная             | PC                                 |
| PA-OSTRGLAX3M-00  | -           | 3      |                              | transparentna<br>transparent<br>прозрачная |                                    |

Ostonki / Covers / Крышки



PA-OSMLGLAX3M-00



PA-OSTRGLAX3M-00

Profil GLAX przegrodowy dwustronny, do wypełnienia obrzeżem  
 GLAX aluminium edge profile – double sided, option to fill with matching edge banding  
 Профиль LED GLAX разделительный, кромочный, двухсторонний

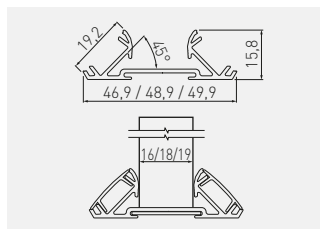

|                    |    |   |                              |  |                                    |
|--------------------|----|---|------------------------------|--|------------------------------------|
| PA-GLAXNBDW3M16-AL | 16 | 3 | profil<br>profile<br>профиль | srebrny<br>silver<br>серебристый           | aluminium<br>aluminium<br>алюминий |
| PA-GLAXNBDW3M-AL   | 18 | 3 |                              |  |                                    |
| PA-GLAXNBDW3M19-AL | 19 | 3 |                              |  |                                    |
| PA-OSMLGLAX3M-00   | -  | 3 | ostonka<br>cover<br>крышка   | mleczna<br>frosted<br>молочная             | PC                                 |
| PA-OSTRGLAX3M-00   | -  |   |                              | transparentna<br>transparent<br>прозрачная |                                    |

Ostonki / Covers / Крышки



PA-OSMLGLAX3M-00



PA-OSTRGLAX3M-00

Profil GLAX kątowy  
GLAX corner profile  
Профиль GLAX угловой

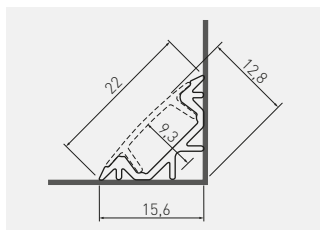

| PA-GLAXKT-AL     | 2 | profil<br>profile<br>профиль    | srebrny<br>silver<br>серебристый   |
|------------------|---|---------------------------------|------------------------------------|
| PA-GLAXKT3M-AL   | 3 |                                 | aluminium<br>aluminium<br>алюминий |
| PA-OSMLGLAX-00   | 2 | osłonka<br>cover<br>крышка      | mleczna<br>frosted<br>молочная     |
| PA-OSMLGLAX3M-00 | 3 |                                 | PC                                 |
| PA-OSTRGLAX-00   | 3 |                                 |                                    |
| PA-OSTRGLAX3M-00 | 2 |                                 |                                    |
| PA-ZASGLAXKT-00  | - | zaślepka<br>end cap<br>заглушка | szary<br>gray<br>серый             |





Profil GLAX kątowy, wpuszczany  
 Recessed corner profile GLAX  
 Профиль GLAX угловой, врезной

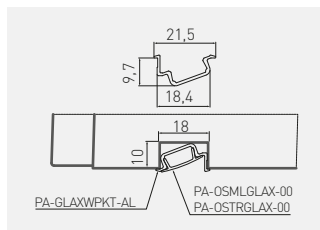

Kąt świecenia 22°  
 Beam angle 22°  
 Угол свечения 22°

| PA-GLAXWPKT-AL | 2 | profil<br>profile<br>профиль | srebrny<br>silver<br>серебристый           | aluminium<br>aluminium<br>алюминий |
|----------------|---|------------------------------|--|------------------------------------|
| PA-OSMLGLAX-00 |   | osłonka<br>cover<br>крышка   | mleczna<br>frosted<br>молочная             | PC                                 |
| PA-OSTRGLAX-00 |   |                              | transparentna<br>transparent<br>прозрачная |                                    |

Ostonki / Covers / Крышки



PA-OSMLGLAX-00



PA-OSTRGLAX-00

Zestaw GLAX wpuszczany  
 GLAX recessed - kit  
 Комплект профиль GLAX врезной

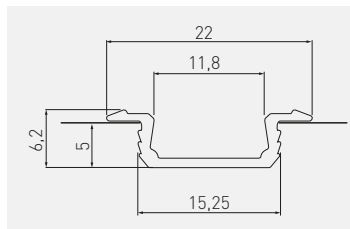

PA-ZGLAXDMZ-00



2



srebrny, silver, серебристый

 aluminium, PC mleczne, ABS  
 aluminium, PC frosted, ABS  
 алюминий, PC молочная, ABS

Zestaw GLAX nakładany mini  
 GLAX profile mini surface mounted - kit  
 Комплект профиль GLAX накладной, мини

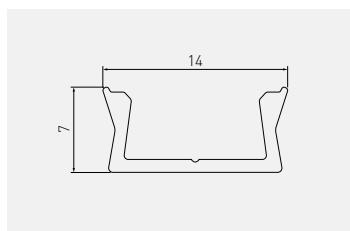

PA-ZGLAXMNKOMZ-00



2



srebrny, silver, серебристый

 aluminium, PC mleczne, ABS  
 aluminium, PC frosted, ABS  
 алюминий, PC молочная, ABS

Zestaw GLAX kątowy  
GLAX corner profile - kit  
Комплект профиль GLAX угловой

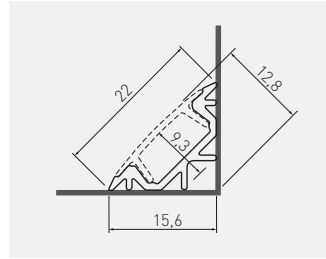

PA-ZGLAXKTOMZ-00

2

srebrny, silver, серебристый

aluminium, PC mleczne, ABS  
aluminium, PC frosted, ABS  
алюминий, PC молочная, ABS

Oprawa VASCO nakładana / wpuszczana  
Fixture Vasco surface mounted / recessed  
Светильник Vasco накладной / врезной

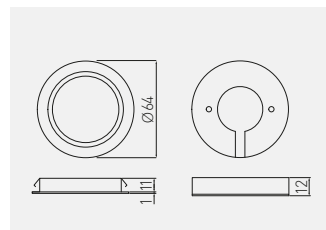

LD-VA24CB-53

130 lm

3000 K

aluminium  
aluminium  
алюминий

tworzywo  
plastic  
пластик

LD-VA24NE-53

4000 K

LD-VA24ZB-53

6000 K



Oprowa LUMINO  
 Fixture LUMINO  
 Светильник LUMINO

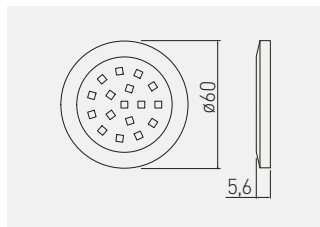

| LD-LU16CB-53 | 70 – 85 lm | 2700 K | biały połysk<br>white gloss<br>белый глянец | tworzywo<br>plastic<br>пластик |
|--------------|------------|--------|---|--------------------------------|
| LD-LU16NE-53 |            | 4000 K |   |                                |
| LD-LU16ZB-53 |            | 6500 K |   |                                |



Oprowa CASTELLO z włącznikiem  
 Fixture CASTELLO with switch  
 Светильник CASTELLO с выключателем

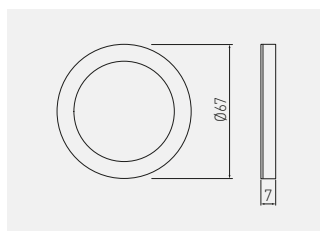

| LD-CS36CB-53 | 180 lm | 3000 K | aluminium<br>aluminium<br>алюминий | tworzywo<br>plastic<br>пластик |
|--------------|--------|--------|------------------------------------|--------------------------------|
| LD-CS36NE-53 |        | 4000 K |                                    |                                |
| LD-CS36ZB-53 |        | 6200 K |                                    |                                |





Оправа ALVARO wpuszczana  
 Recessed fixture ALVARO  
 Врезной светильник ALVARO

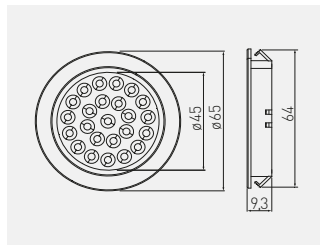

|              |        |        |                                    |                                |
|--------------|--------|--------|------------------------------------|--------------------------------|
|              |        |        |                                    |                                |
| LD-AL24CB-53 | 130 lm | 3000 K | aluminium<br>aluminium<br>алюминий | tworzywo<br>plastic<br>пластик |
| LD-AL24NE-53 |        | 4000 K |                                    |                                |
| LD-AL24ZB-53 |        | 6400 K |                                    |                                |



Оправа VEGAS  
 Fixture VEGAS  
 Светильник VEGAS

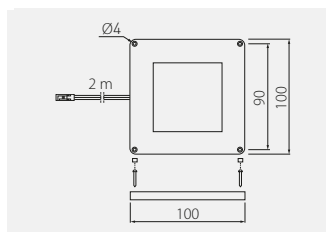

|               |        |        |                                    |  |
|---------------|--------|--------|------------------------------------|--|
|               |        |        |                                    |  |
| LD-VE15CB-53N | 140 lm | 3000 K | aluminium<br>aluminium<br>алюминий | tworzywo / aluminium<br>plastic / aluminium<br>пластмасса / алюминий |
| LD-VE15NE-53N | 145 lm | 4000 K |                                    |  |
| LD-VE15ZB-53N | 150 lm | 6400 K |                                    |  |



Оправа VEGAS 2 w 1  
 Fixture VEGAS 2 in 1  
 Светильник VEGAS 2 в 1

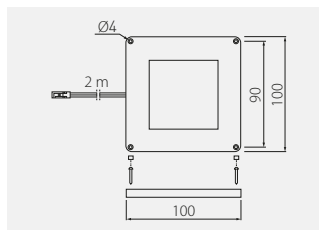

Powiązane produkty:  
 Włącznik dotykowy bezprzewodowy CCT  
 AE-WDBP2CCT-10, AE-WDBP2CCT-20  
 Related products:  
 Wireless touchless switch CCT  
 AE-WDBP2CCT-10, AE-WDBP2CCT-20  
 Связанные с ними продукты:  
 Беспроводной сенсорный выключатель CCT  
 AE-WDBP2CCT-10, AE-WDBP2CCT-20



|                 |        |                 |                                    |   |
|-----------------|--------|-----------------|------------------------------------|---|
|                 |        |                 |                                    |   |
| LD-VE15CBZB-53N | 140 lm | 3000 K – 6400 K | aluminium<br>aluminium<br>алюминий | tworzywo, aluminium<br>plastic, aluminium<br>пластмасса, алюминий |



Оправа TREVI  
 Fixture TREVI  
 Светильник TREVI

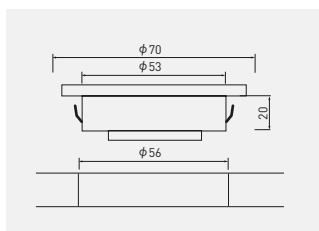

|              |        |        |                                    |                                |
|--------------|--------|--------|------------------------------------|--------------------------------|
|              |        |        |                                    |                                |
| LD-TR24CB-53 | 300 lm | 3000 K | aluminium<br>aluminium<br>алюминий | tworzywo<br>plastic<br>пластик |
| LD-TR24NE-53 | 220 lm | 4000 K |                                    |                                |
| LD-TR24ZB-53 | 300 lm | 6400 K |                                    |                                |



Zestaw opraw CASTELLO z włącznikiem  
 Fixture kit with switch CASTELLO  
 Комплект светильников CASTELLO с выключателем

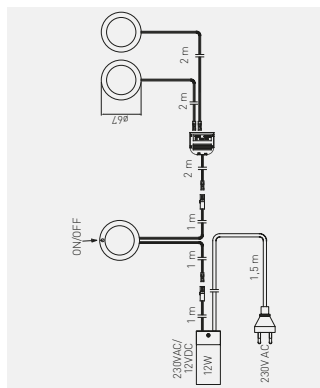

|              |            |          |                                  |                              |
|--------------|------------|----------|----------------------------------|------------------------------|
|              |            |          |                                  |                              |
| LD-Z3CSCB-53 | 3 x 180 lm | ● 3000 K | aluminium / aluminium / алюминий | tworzywo / plastic / пластик |
|              |            |          |                                  |                              |
|              |            |          |                                  |                              |
|              |            |          |                                  |                              |

Zestaw opraw BARRI  
 Fixture kit BARRI  
 Комплект светильников BARRI

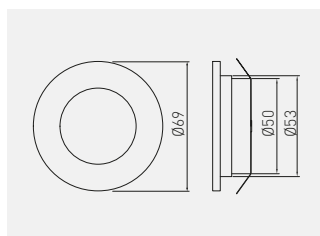

|               |           |          |                                    |   |
|---------------|-----------|----------|------------------------------------|---|
|               |           |          |                                    |   |
| LD-OBP27CB-53 | 3 x 80 lm | ● 2700 K | aluminium<br>aluminium<br>алюминий | aluminium, tworzywo<br>aluminium, plastic<br>алюминий, пластмасса |
| LD-OBP27ZB-53 |           | ● 6400 K |                                    |   |
|               |           |          |                                    |   |
|               |           |          |                                    |   |
|               |           |          |                                    |   |



Zestaw opraw MARBELLA  
 Fixture kit MARBELLA  
 Комплект светильников MARBELLA

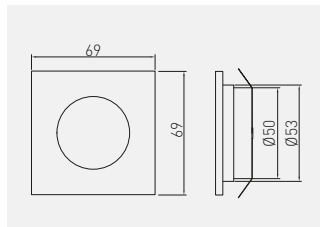

|               |           |          |                                    |   |
|---------------|-----------|----------|------------------------------------|---|
|               |           |          |                                    |   |
| LD-KWP27CB-53 | 3 x 80 lm | ● 2700 K | aluminium<br>aluminium<br>алюминий | aluminium, tworzywo<br>aluminium, plastic<br>алюминий, пластмасса |
| LD-KWP27ZB-53 |           | ● 6400 K |                                    |   |



Oprawa OVIEDO wpuszczana  
 Recessed fixture OVIEDO  
 Врезной светильник OVIEDO

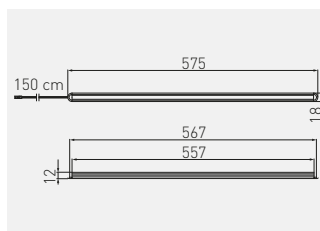

|              |       |          |                                    |   |
|--------------|-------|----------|------------------------------------|---|
|              |       |          |                                    |   |
| LD-WL2457-53 | 90 lm | ● 6400 K | aluminium<br>aluminium<br>алюминий | aluminium, tworzywo<br>aluminium, plastic<br>алюминий, пластмасса |



Оправа OPD podszafkowa  
Under cabinet LED lamp fixture OPD  
Светодиодный светильник OPD под шкафчик

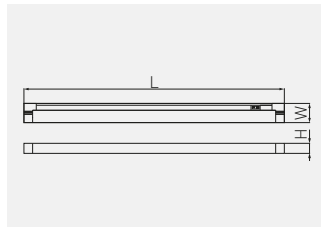

|              |     |        |          |                              |  |  |
|--------------|-----|--------|----------|------------------------------|--|--|
|              |     |        |          |                              |  |  |
| LD-OPD5W0-CB | 5 W | 300 lm | ● 3000 K | L:W:H<br>325 × 30 × 22<br>mm |  |  |
| LD-OPD9W0-CB | 9 W | 350 lm |          | 585 × 30 × 22                |  |  |



Оправа RADIUS II na wysięgniku  
Fixture with arm RADIUS II  
Светильник типа „дуга” RADIUS II

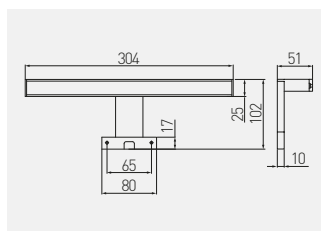

|               |        |          |  |  |
|---------------|--------|----------|--|--|
|               |        |          |  |  |
| LD-RA60CB-40N | 220 lm | ● 3000 K |  |  |
| LD-RA60ZB-40N |        | ● 6000 K |  |  |



## Oprawa COMA bezprzewodowa

### Wireless fixture COMA

### Беспроводной светильник COMA



LD-IRUSB-53

LD-PIRUSB-53

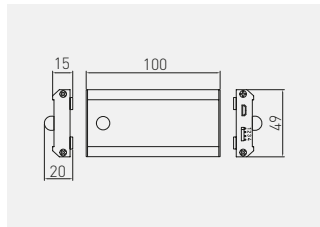

Dodatkowy przewód USB (do ładowania) - 0,5 m w komplecie  
Additional 0,5m USB cable (for charging)

Дополнительный кабель USB (для зарядки) - 0,5 м

|              |  |  |  |  |                                    |   |
|--------------|--|--|--|--|------------------------------------|---|
|              |  |  |  |  |                                    |   |
| LD-IRUSB-53  |  |  |  | Czujnik zbliżeniowy IR, jedno- lub dwubiegowy<br>Proximity sensor IR, single or double-pole<br>Датчик движения IR, одно- и многофункциональный | aluminium<br>aluminium<br>алюминий | stal, tworzywo<br>steel, plastic<br>сталь, пластмасса |
| LD-PIRUSB-53 |  |  |  | Czujnik ruchu PIR, jednobiegowy<br>Proximity sensor IR, single-pole<br>Датчик движения PIR, однофункциональный                                 |                                    |   |



## Lampka CHICAGO z portem USB

### Bed lamp with USB CHICAGO

### Гибкая лампа с USB-разъемом CHICAGO

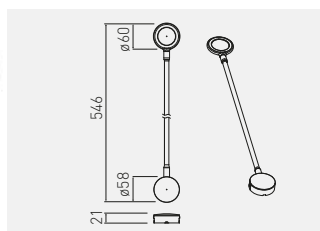

Wymaga zasilacza 12 V, 24 W  
Requires 12 V, 24 W power supply  
Требуется блок питания 12 В, 24 Вт

|                   |  |  |  |                         |   |  |
|-------------------|--|--|--|-------------------------|---|--|
|                   |  |  |  |                         |   |  |
| LD-CHIC16NE-10DIM |  |  |  | biały / white / белый   | metal, tworzywo<br>metal, plastic<br>металл, пластмасса |  |
| LD-CHIC16NE-20DIM |  |  |  | czarny / black / чёрный |   |  |



Lampka BOSTON  
Lamp BOSTON  
Лампа BOSTON

360°

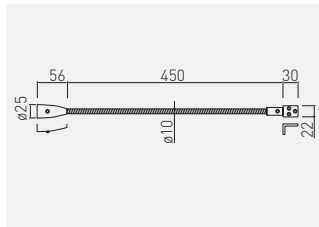

Wymaga zasilacza 12 V, 6 W  
Requires 12 V, 6 W power supply  
Требуется блок питания 12 В, 6 Вт

|                |       |          |                                    |   |
|----------------|-------|----------|------------------------------------|---|
|                |       |          |                                    |   |
| LD-BOS1CBWG-53 | 90 lm | ● 3000 K | aluminium<br>aluminium<br>алюминий | stal, aluminium, tworzywo<br>steel, aluminium, plastic<br>сталь, алюминий, пластика |
|                |       |          |                                    |   |
|                |       |          |                                    |   |
|                |       |          |                                    |   |

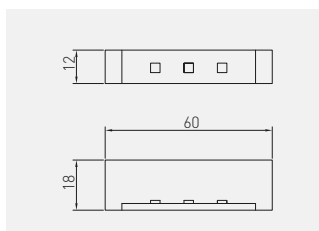

Klip plastikowy LED do półek  
Plastic LED clip for shelves  
Пластиковая клипса LED для стеклянных полок

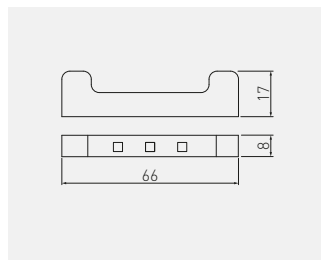

|              |       |                          |                                |
|--------------|-------|--------------------------|--------------------------------|
|              |       |                          |                                |
| LD-KLPCB-00N | 10 lm | ● 3000 K                 | tworzywo<br>plastic<br>пластик |
| LD-KLPNB-00N | -     | niebieski / blue / синий |                                |
| LD-KLPZB-00N | 12 lm | ● 6400 K                 |                                |
|              |       |                          |                                |
|              |       |                          |                                |
|              |       |                          |                                |
|              |       |                          |                                |

Klip metalowy LED do pótek  
Metal LED clip for shelves  
Металлическая клипса LED для стеклянных полок







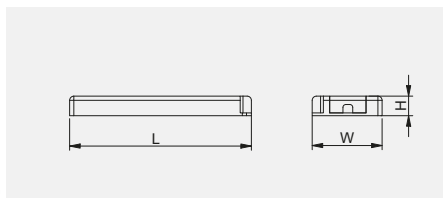

|             |  |  |  |  |
|-------------|---|---|---|---|
| LD-3SKL-CBN |   | 10 lm   | 3000 K  | stal<br>steel<br>сталь  |
| LD-3SKL-NBN |   | -   | niebieski / blue / синий  |   |
| LD-3SKL-ZBN |   | 12 lm   | 6400 K  |   |



Zasilacz LED EASY CLIK  
LED power supply EASY CLIK  
Блок питания LED EASY CLIK







|                |  |  |  |  |  |  |  |
|----------------|---|---|---|---|---|---|---|
| LD-ZAS09WEC-30 | 9 W   | 3 miniAMP   | 0,75 A  | 103 x 41 x 12mm   | tworzywo<br>plastic<br>пластик  | 110 g   |   |
| LD-ZAS15WEC-30 | 15 W  | 4 miniAMP   | 1,25 A  | 129 x 42 x 16 mm  |   | 130 g   |   |
| LD-ZAS20WEC-30 | 20 W  |   | 1,67 A  | 129 x 42 x 16 mm  |   | 140 g   |   |
| LD-ZAS30WEC-30 | 30 W  | 6 miniAMP   | 2,5 A   | 160 x 50 x 18 mm  |   | 190 g   |   |
| LD-ZAS60WEC-30 | 60 W  |   | 5 A   | 190 x 62 x 21 mm  |   | 290 g   |   |

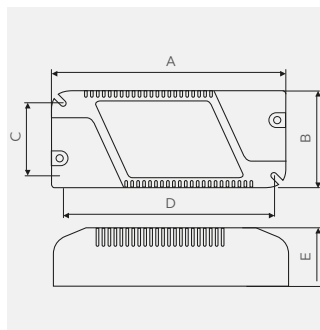

Zasilacz LED  
LED power supply  
Светодиодный трансформатор LED







|   |   |   |   |   |
|---|---|---|---|---|
|  |  |  |  |  |
| LD-ZAS75W-30  | max 75 W  | 180 x 52 x 42 x 176 x 30  | 350 g   | tworzywo plastic пластик  |

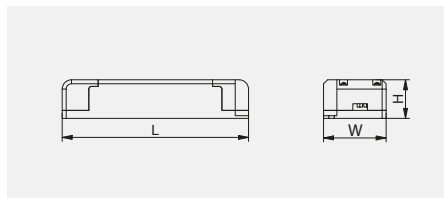

Zasilacz LED 24 V  
LED power supplies 24 V  
Блоки питания LED 24 V



|   |   |   |   |   |
|---|---|---|---|---|
|  |  |  |  |  |
| LD-ZAS24PRO80W-30   | max. 80 W   | 181 x 63 x 40 mm  | 300 g   | tworzywo plastic пластик  |



Układ zasilający  
Power feeder set  
Блок питания



|                 |      |               |                                |
|-----------------|------|---------------|--------------------------------|
| LD-ZZAS07PROKD6 | 7 W  | 100 x 39 x 25 | tworzywo<br>plastic<br>пластик |
| LD-ZZAS12PROKD6 | 12 W | 120 x 42 x 27 |                                |
| LD-ZZAS16PROKD6 | 16 W | 120 x 42 x 27 |                                |
| LD-ZZAS24PROKD6 | 24 W | 140 x 47 x 29 |                                |
| LD-ZZAS33PROKD6 | 33 W | 155 x 53 x 30 |                                |

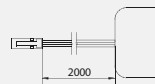
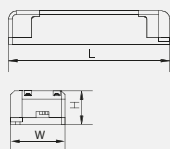

Zasilacz LED PRO  
LED PRO power feeder units  
Блоки питания LED PRO

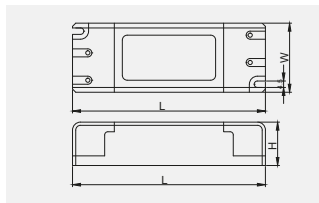

|                 |      |                  |                                |
|-----------------|------|------------------|--------------------------------|
| LD-ZASPRO07W-30 | 7 W  | 100 x 39 x 25 mm | tworzywo<br>plastic<br>пластик |
| LD-ZASPRO12W-30 | 12 W | 120 x 42 x 27 mm |                                |
| LD-ZASPRO16W-30 | 16 W | 120 x 42 x 27 mm |                                |
| LD-ZASPRO24W-30 | 24 W | 140 x 47 x 29 mm |                                |
| LD-ZASPRO33W-30 | 33 W | 140 x 47 x 29 mm |                                |
| LD-ZASPRO54W-30 | 54 W | 155 x 53 x 30 mm |                                |
| LD-ZASPRO65W-30 | 65 W | 181 x 63 x 40 mm |                                |
| LD-ZASPRO80W-30 | 80 W | 181 x 63 x 40 mm |                                |



Zasilacz LED  
Power supply  
Блок питания для светодиодных светильников

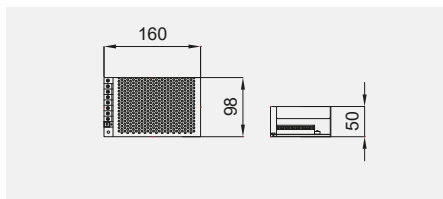

|              |            |       |                                    |
|--------------|------------|-------|------------------------------------|
| LD-ZAS150-NW | max. 150 W | 347 g | aluminium<br>aluminium<br>алюминий |
|--------------|------------|-------|------------------------------------|





Zasilacz LED  
Power supply  
Блок питания для светодиодных светильников

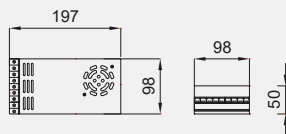

|              |            |       |                                    |
|--------------|------------|-------|------------------------------------|
|              |            |       |                                    |
| LD-ZAS350-NW | max. 350 W | 589 g | aluminium<br>aluminium<br>алюминий |



Zasilacz LED  
Power supply  
Блок питания для  
светодиодных светильников



|               |       |        |                                |
|---------------|-------|--------|--------------------------------|
| LD-WZA20W-NW  | 20 W  | 170 g  | tworzywo<br>plastic<br>пластик |
| LD-WZA36W-NW  | 36 W  | 310 g  |                                |
| LD-WZA60W-NW  | 60 W  | 990 g  |                                |
| LD-WZA80W-NW  | 80 W  | 1000 g |                                |
| LD-WZA150W-NW | 150 W | 2000 g |                                |

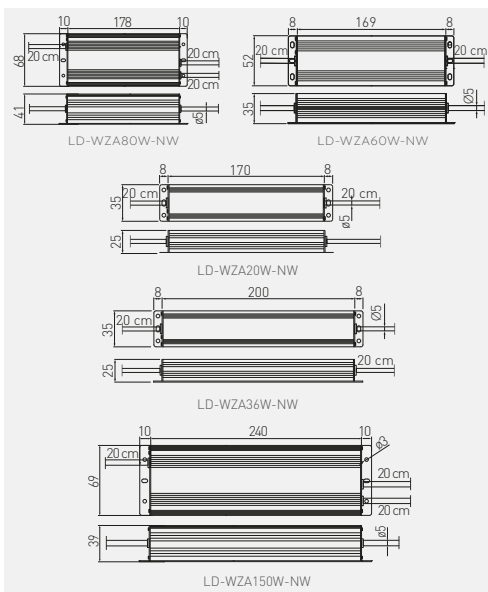

Zasilacz LED puszkowy  
LED power supply  
Светодиодный трансформатор LED

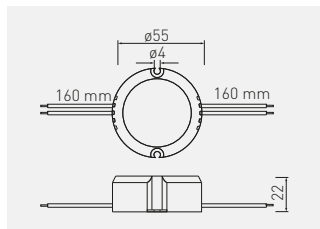

LD-ZASPU15W-30N

15 W

tworzywo / plastic / пластик



Układ zasilający do klipów LED 5-punktowy  
Power supply set for 5 LED clips  
Блок питания для светодиодных клипс, 5 разъёмов

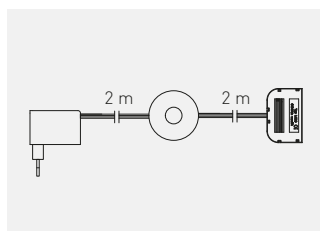

LD-ZSKL 15-00N

tworzywo / plastic / пластик



Układ zasilający  
Power supply set  
Блок питания

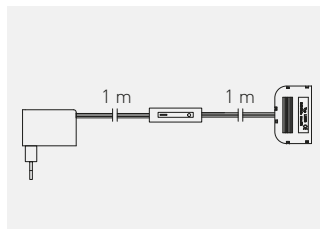

|              |           |                  |
|--------------|-----------|------------------|
|              |           |                  |
| LD-ZWND6W-10 | max. 6 W  | tworzywo plastic |
| LD-ZWND12-10 | max. 12 W | пластик          |



Zestaw RGB – kontroler, zasilacz LED 6W, pilot i dystrybutor  
RGB kit – RGB controller, power supply, remote and distributor  
Комплект RGB – контролер, трансформатор 6W, пульт, дистрибьютор

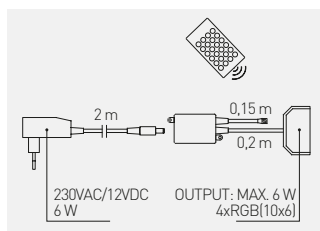

|                |     |                              |
|----------------|-----|------------------------------|
|                |     |                              |
| LD-ZAC6WDE-RGB | RGB | tworzywo / plastic / пластик |



Kontroler RGB mini z pilotem  
Mini RGB controller with remote  
Миниконтроллер RGB с пультом

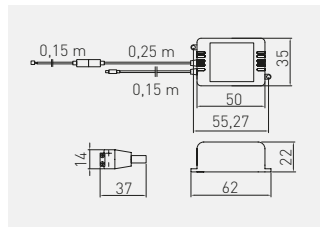

LD-KONMINI-RGB

RGB

tworzywo / plastic / пластик



Kontroler 1-strefowy MONO  
 1-zone controller MONO  
 1-зонный контроллер MONO

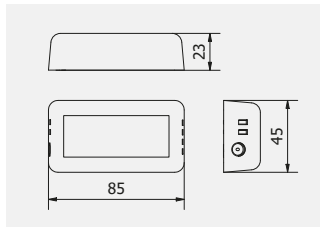

|   |   |   |
|---|---|---|
|  |  |  |
| LD-KONML-MONO   | MONO  | tworzywo / plastic / пластик  |



Pilot 4-strefowy MONO  
 4-zone remote controller MONO  
 4-зонный пульт дистанционного управления MONO

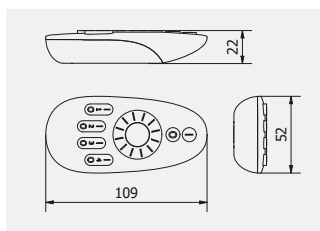

|   |   |
|---|---|
|  |  |
| LD-KONML-MONO-PIL   | tworzywo / plastic / пластик  |



Panel dotykowy 4-strefowy na baterie MONO  
 Battery powered 4-zone touch panel MONO  
 4-зонная сенсорная панель с батарейками MONO

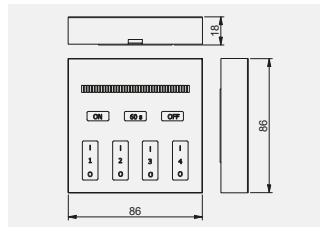

LD-KONML-MONO-PAN

tworzywo / plastic / пластик



Kontroler 1-strefowy RGBW  
 1-zone controller RGBW  
 1-зонный контроллер RGBW

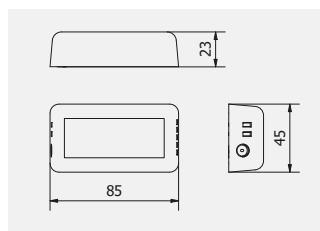

LD-KONML-RGBW

RGBW

tworzywo / plastic / пластик



Pilot 4-strefowy RGBW  
 4-zone remote controller RGBW  
 4-зонный пульт дистанционного управления RGBW

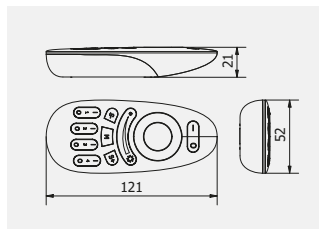

|                   |      |                              |
|-------------------|------|------------------------------|
|                   |      |                              |
| LD-KONML-RGBW-PIL | RGBW | tworzywo / plastic / пластик |



Panel dotykowy 4-strefowy na baterie RGBW  
 Battery powered 4-zone touch panel RGBW  
 4-зонная сенсорная панель с батарейками RGBW

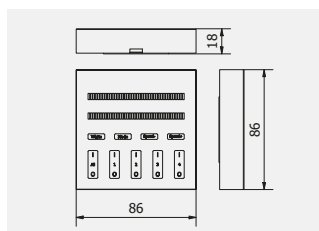

|                   |      |                              |
|-------------------|------|------------------------------|
|                   |      |                              |
| LD-KONML-WRGB-PAN | RGBW | tworzywo / plastic / пластик |



Kontroler WiFi  
WiFi-controller  
WiFi – контроллер

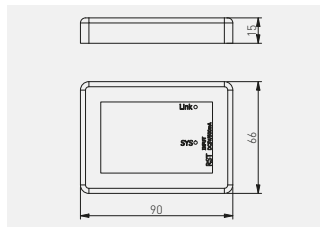

LD-KONML-WIFI

RGB

tworzywo / plastic / пластик



Adapter do pilota  
Remote control adapter  
Адаптер пульта дистанционного управления

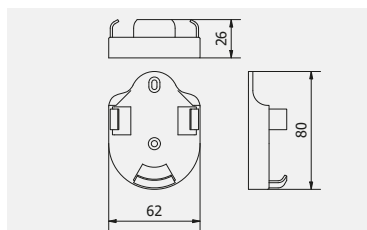

LD-KONML-AD

biały / white / белый

tworzywo / plastic / пластик





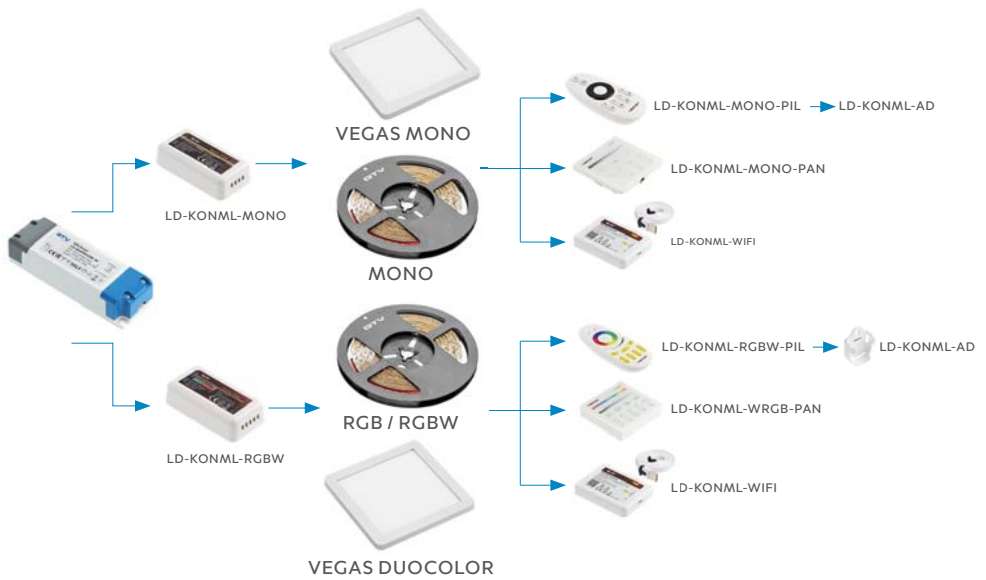

Włącznik dotykowy bezprzewodowy on-off  
 Wireless touch switch on-off  
 Беспроводной сенсорный выключатель on-off

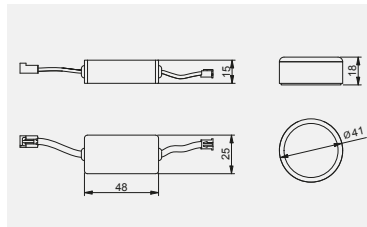

|              |                         |                             |
|--------------|-------------------------|-----------------------------|
|              |                         |                             |
| AE-WDBP1-10N | biały / white / белый   | tworzywo plastic<br>plastik |
| AE-WDBP1-20N | czarny / black / чёрный |                             |



Włącznik dotykowy bezprzewodowy CCT  
 Wireless touch switch CCT  
 Беспроводной сенсорный выключатель CCT

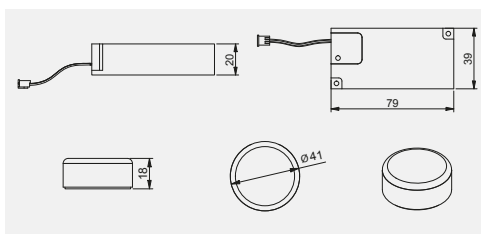

|                 |                         |                             |
|-----------------|-------------------------|-----------------------------|
|                 |                         |                             |
| AE-WDBP2CCT-10N | biały / white / белый   | tworzywo plastic<br>plastik |
| AE-WDBP2CCT-20N | czarny / black / чёрный |                             |





Włącznik bezdotykowy  
Touchless switch  
Бесконтактный датчик

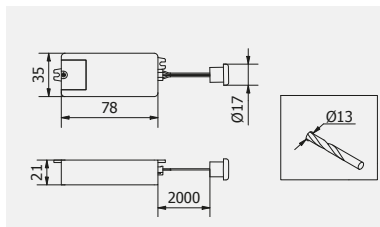

|                |   |                                |
|----------------|---|--------------------------------|
|                |   |                                |
| AE-WBEZDC-10S  | dwubiegowy<br>two-pole<br>двухфункциональный      | tworzywo<br>plastic<br>пластик |
| AE-WBEZDB-10S* | jednobiegowy<br>single-pole<br>однофункциональный |                                |



Włącznik dotykowy pod śrubę  
Touch switch under screw  
Сенсорный выключатель под винт

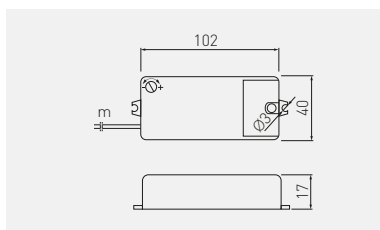

|                |  |                                   |
|----------------|--|-----------------------------------|
|                |  |                                   |
| AE-WBEZDK15-10 |  | tworzywo<br>plastic<br>пластмасса |



Włącznik z czujnikiem ruchu PIR  
 Switch with PIR motion detector  
 Выключатель с датчиком движения PIR

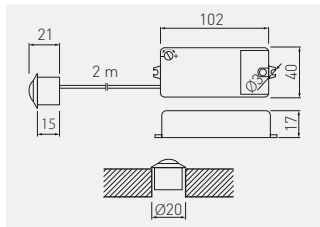

|   |   |
|---|---|
|  |  |
| AE-WBEZDPIR-10  | tworzywo plastic<br>пластмасса  |



Włącznik z dwoma sensorami ruchu PIR II  
 Switch with two PIR II motion sensors  
 Выключатель с двумя датчиками движения PIR II

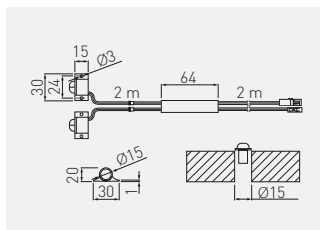

|   |   |
|---|---|
|  |  |
| AE-WBEZDPIR2-20   | tworzywo plastic<br>пластмасса  |



Włącznik bezdotykowy uniwersalny 3 w 1  
 3 in 1 all-purpose touchless switch  
 Бесконтактный выключатель 3 в 1



AE-ADCUNI-10

AE-ADBUNI-10

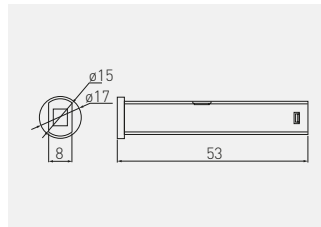

|                 |                         |                                |
|-----------------|-------------------------|--------------------------------|
| AE-WBBUNI-10DIM | biały / white / белый   | tworzywo<br>plastic<br>пластик |
| AE-WBCUNI-10DIM | czarny / black / чёрный |                                |



Włącznik dotykowy ściemniający  
 Dimmable touch switch  
 Выключатель с регулятором яркости

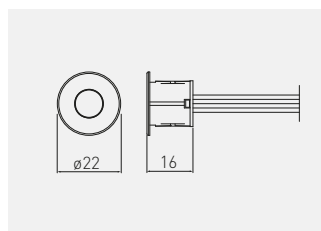

|               |                         |                                |
|---------------|-------------------------|--------------------------------|
| AE-WDSB-10DIM | biały / white / белый   | tworzywo<br>plastic<br>пластик |
| AE-WDSC-10DIM | czarny / black / чёрный |                                |



Włącznik dotykowy ściemniający  
Dimmable touch switch  
Выключатель с регулятором яркости

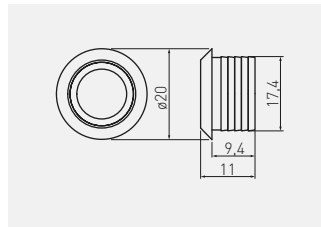

|             |                         |                                |
|-------------|-------------------------|--------------------------------|
|             |                         |                                |
| AE-WBEZD-NB | chrom<br>chrome<br>хром | tworzywo<br>plastic<br>пластик |



Włącznik podblatowy  
Countertop switch  
Выключатель под столешницу

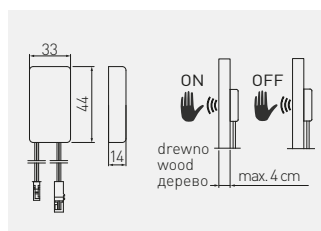

Grubość blatu max. 40 mm  
Countertop thickness max. 40 mm  
Толщина столешницы макс. 40 мм

|             |                              |
|-------------|------------------------------|
|             |                              |
| AE-WPDRW-00 | tworzywo / plastic / пластик |



Włącznik do taśm LED montowany w profil  
 Switch for LED strips mounted in profile  
 Выключатель для ленты LED

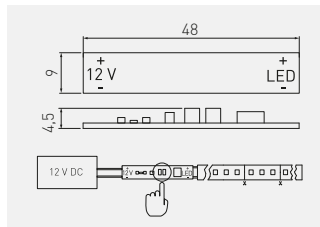

|              |     |                         |  |      |
|--------------|-----|-------------------------|--|------|
|              |     |                         |  |      |
| AE-WLPR-60   | -   | biały<br>white<br>белый | plytka elektroniczna<br>circuit board<br>электронная плата | 1000 |
| AE-WLPR-60P2 | 2 m |                         |  | 500  |



Włącznik kotykowski  
 Switch  
 Выключатель кнопочный

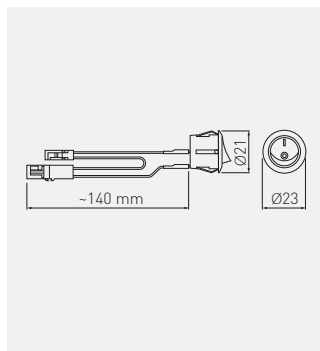

|             |                         |                                |
|-------------|-------------------------|--------------------------------|
|             |                         |                                |
| AE-WLB01-10 | biały / white / белый   | tworzywo<br>plastic<br>пластик |
| AE-WLC01-20 | czarny / black / чёрный |                                |





Przetącnik kotyskowy okrągły  
 Round rocker switch  
 Выключатель клавишный круглый



|   |   |   |
|---|---|---|
|  |  |  |
| AE-WLIP44-15  | biały<br>white<br>белый   | tworzywo<br>plastic<br>пластмасса   |



Ściemniacz LED  
 LED dimmer  
 Светодиодный диммер

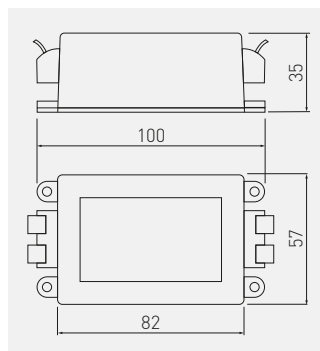

|   |   |   |
|---|---|---|
|  |  |  |
| LD-DIMLED-10  | czarny / black / чёрный   | PC  |



Włącznik łańcuszkowy  
 Pull chain switch  
 Выключатель для бра и торшеров с цепочкой

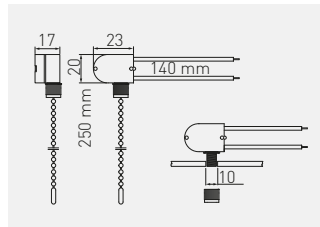

|              |                         |                              |
|--------------|-------------------------|------------------------------|
| AE-WLLAN1-10 | chrom / chrome / хром   | tworzywo / plastic / пластик |
| AE-WLLAN1-90 | złoty / gold / золотой  |                              |
| AE-WLLAN1-20 | czarny / black / чёрный |                              |



Włącznik sznurkowy  
 Pull cable switch  
 Шнуровой выключатель









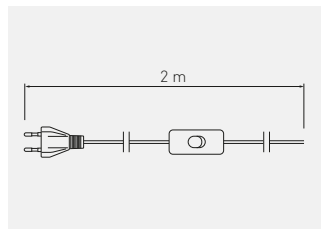



|              |                         |   |
|--------------|-------------------------|---|
| AE-WLSZN1-10 | czarny / black / чёрный | polipropylen / polypropylene / полипропилен |
|--------------|-------------------------|---|











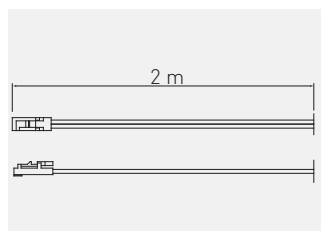

Kabel zasilający z wtyczką i włącznikiem  
 Cable with plug & switch  
 Кабель с вилкой и выключателем



|   |   |   |
|---|---|---|
|  |  |  |
| LD-KABE2M-00  | biały / white / белый   | tworzywo / plastic / пластик  |
|  |  |  |
|  |  |  |
|  |  |  |

Przewód ze złączką mini AMP  
 Cable with Mini AMP  
 Кабель с соединителем мини-AMP



|   |   |   |
|---|---|---|
|  |  |  |
| LZ-KA2MM-10   | czarny / black / чёрный   | tworzywo / plastic / пластик  |
|  |  |  |
|  |  |  |
|  |  |  |

Przewód ze złączkami mini AMP  
 Cable with Mini AMP  
 Кабель с соединителями мини-AMP

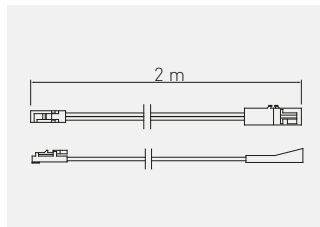

|   |   |   |
|---|---|---|
|  |  |  |
| LZ-KAPR2M-10  | czarny / black / чёрный   | tworzywo / plastic / пластик  |





















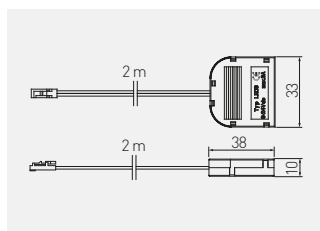



Złączka do oświetlenia ledowego z dystrybutorem, 3 gniazda  
 LED lamp connector with distributor, 3 sockets  
 Соединитель LED с распределителем, 3 гнезда





|   |   |   |
|---|---|---|
|  |  |  |
| LZ-AKZ312-10N   | czarny / black / чёрный   | tworzywo / plastic / пластик  |























Złączka do oświetlenia ledowego z dystrybutorem, 6 gniazd  
 LED lamp connector with distributor, 6 sockets  
 Соединитель LED с распределителем, 6 гнезд

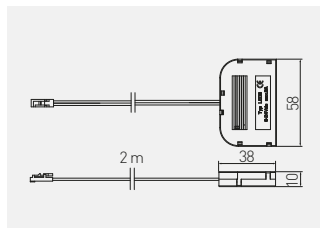

|               |                         |                              |
|---------------|-------------------------|------------------------------|
|               |                         |                              |
| LZ-AKZ612-10N | czarny / black / чёрный | tworzywo / plastic / пластик |

Złączka XC11 do taśm LED  
 Connector XC11 for LED strips  
 Соединитель XC11 для лент LED



LD-ZTL8MM-02N



LD-ZTL8MM-02N600



LD-ZTL10MM-02N



LD-ZTLRGB-04N

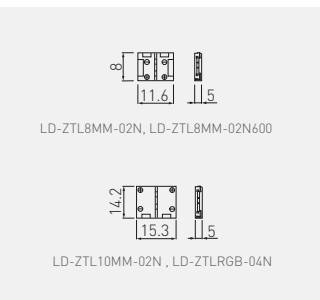

|                  |               |                                |
|------------------|---------------|--------------------------------|
|                  |               |                                |
| LD-ZTL8MM-02N    | 8 mm          | tworzywo<br>plastic<br>пластик |
| LD-ZTL8MM-02N600 | 8 mm, 600 LED |                                |
| LD-ZTL10MM-02N   | 10 mm         |                                |
| LD-ZTLRGB-04N    | RGB           |                                |

Złącza XC11 do taśm LED kątowna  
 Angular connector XC11 for LED strips  
 Угловой соединитель XC11 для лент LED

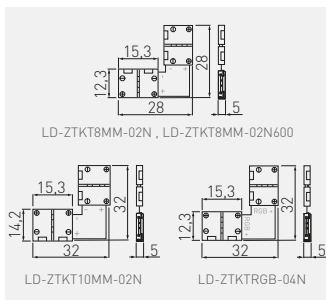

| LD-ZTKT8MM-02N    | 8 mm           | tworzywo<br>plastic<br>пластик |
|-------------------|----------------|--------------------------------|
| LD-ZTKT8MM-02N600 | 8 mm / 600 LED |                                |
| LD-ZTKT10MM-02N   | 10 mm          |                                |
| LD-ZTKTRGB-04N    | RGB            |                                |



Złącza XC11 do taśm LED z przewodem 15 cm  
 Connector XC11 with 15 cm cord, for strips  
 Соединитель XC11 для лент LED, с проводом 15 см

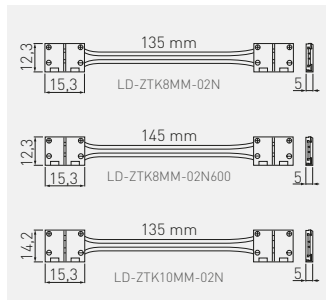

| LD-ZTK8MM-02N    | 8 mm           | tworzywo<br>plastic<br>пластик |
|------------------|----------------|--------------------------------|
| LD-ZTK8MM-02N600 | 8 mm / 600 LED |                                |
| LD-ZTK10MM-02N   | 10 mm          |                                |



Złącza XC11 do taśm LED z przewodem 2 m  
 Connector XC11 with 2 m cord, for LED strips  
 Соединитель XC11 для лент LED, с проводом 2 м



LD-ZTL82M-2N

LD-ZTL82M-2N600

LD-ZTL102M-2N

LD-ZTLRGB2M-4N

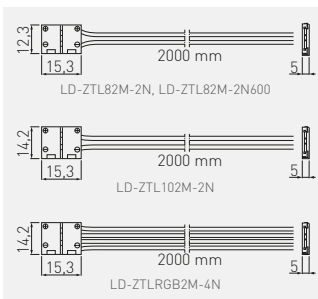

|                 |                |                                |
|-----------------|----------------|--------------------------------|
| LD-ZTL82M-2N    | 8 mm           | tworzywo<br>plastic<br>пластик |
| LD-ZTL82M-2N600 | 8 mm / 600 LED |                                |
| LD-ZTL102M-2N   | 10 mm          |                                |
| LD-ZTLRGB2M-4N  | RGB            |                                |



Złącza XC11 do taśm LED z przewodem 2 m i mini amp  
 Connector XC11 with 2 m cord and mini AMP, for LED strips  
 Соединитель XC11 для лент LED, с проводом 2 м и мини amp

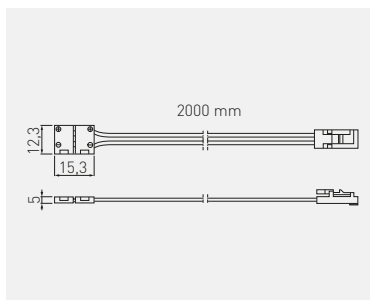

|                     |                |                                |
|---------------------|----------------|--------------------------------|
| LD-ZTL8MMAMP-02N    | 8 mm           | tworzywo<br>plastic<br>пластик |
| LD-ZTL8MMAMP-02N600 | 8 mm / 600 LED |                                |



Złączka XC11 do taśm LED SLIM  
 Connector XC11 for LED strips SLIM  
 Соединитель XC11 для лент LED SLIM



LD-ZTLS8MM-02N    LD-ZTKS8MM-02N    LD-ZTLS82M-2N    LD-ZTLS8MMAMP-02N

|                   |      |                             |
|-------------------|------|-----------------------------|
|                   |      |                             |
| LD-ZTLS8MM-02N    | 8 mm | tworzywo plastic<br>пластик |
| LD-ZTKS8MM-02N    |      |                             |
| LD-ZTLS82M-2N     |      |                             |
| LD-ZTLS8MMAMP-02N |      |                             |

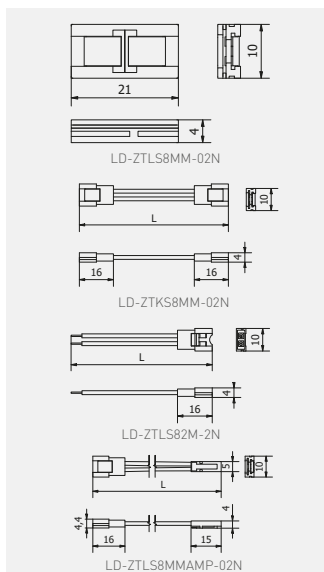

Ładowarka indukcyjna z zasilaczem  
 Wireless charger with power supply  
 Беспроводное зарядное устройство с блоком питания

360°

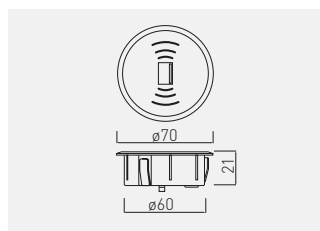

|            |                         |                                |
|------------|-------------------------|--------------------------------|
|            |                         |                                |
| AE-ZUSB-20 | czarny / black / чёрный | tworzywo plastic<br>пластмасса |





Ładowarka bezprzewodowa, indukcyjna, podblatowa z zasilaczem  
 Wireless surface charger, under the countertop mount  
 Беспроводное зарядное устройство, под столешницу

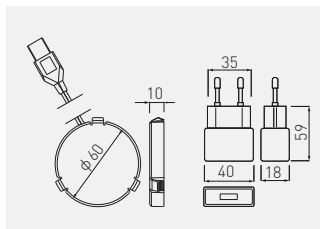

|               |                         |                            |
|---------------|-------------------------|----------------------------|
|               |                         |                            |
| AE-ZLADPOD-20 | czarny / black / чёрный | tworzywo plastic / пластик |



Ładowarka bezprzewodowa LUX z zasilaczem  
 Inductive charger with a power feeder LUX  
 Зарядное устройство индукционное с блоком питания LUX

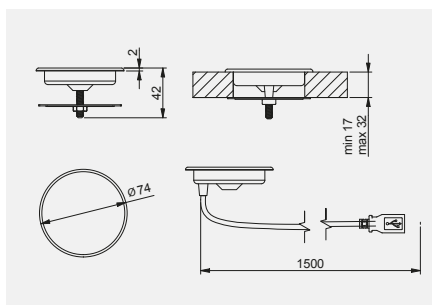

|               |                       |                            |
|---------------|-----------------------|----------------------------|
|               |                       |                            |
| AE-ZLADLUX-40 | chrom / chrome / хром | tworzywo plastic / пластик |



Gniazdo meblowe wpuszczane PRESTINO  
 Recessed power socket PRESTINO  
 Мебельная розетка врезная PRESTINO



AE-PB2FPRES-10



AE-PB2FPRES-20



AE-PB2FPRES-53



AE-PB2SPRES-10



AE-PB2SPRES-20



AE-PB2SPRES-53



|                |   |            |                                      |  |
|----------------|---|------------|--------------------------------------|--|
| AE-PB2FPRES-20 | USB-A + USB-C<br>DC5V 3A (max 15,0W)<br>DC9V 2A (MAX. 18,0W)<br>DC12V 1.5A (MAX. 18,0W) | 2 x french | aluminium,<br>aluminio,<br>Aluminium | aluminium + Plastique,<br>aluminio + plastico,<br>Aluminium + Kunststoff |
| AE-PB2SPRES-20 |   | 2 x schuko |                                      |  |
| AE-PB2FPRES-53 |   | 2 x french |                                      |  |
| AE-PB2SPRES-53 |   | 2 x schuko |                                      |  |
| AE-PB2FPRES-10 |   | 2 x french |                                      |  |
| AE-PB2SPRES-10 |   | 2 x schuko |                                      |  |

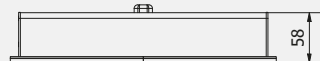
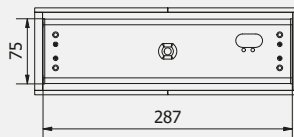
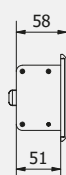
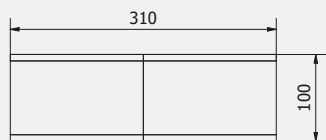



Gniazdo meblowe wpuszczane CHARGER PLUS  
 Recessed power socket CHARGER PLUS  
 Мебельная розетка врезная CHARGER PLUS



AE-BPW1FACP-10



AE-BPW1SACP-10

| AE-BPW1FACP-10 | USB A+C 5V/2,4A<br>interchangeable:<br>USB A, HDMI, RJ45 | 1 x french | biały / white / белый   | tworzywo<br>plastic<br>пластик |
|----------------|--|------------|-------------------------|--------------------------------|
| AE-BPW1FACP-20 |  | 1 x french | czarny / black / чёрный |                                |
| AE-BPW1SACP-10 |  | 1 x schuko | biały / white / белый   |                                |
| AE-BPW1SACP-20 |  | 1 x schuko | czarny / black / чёрный |                                |

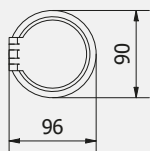



Gniazdo meblowe wpuszczane COMFORT PLUS  
 Recessed power socket COMFORT PLUS  
 Мебельная розетка врезная COMFORT PLUS



AE-BPW4F120P-10



AE-BPW4S120P-10

| AE-BPW4F120P-10 | 2xUSB 5V/3,1A<br>AC/DC; 5,12,24,220-240V;<br>50-60Hz | 4 x french | biały / white / белый   | tworzywo<br>plastik<br>пластик |
|-----------------|--|------------|-------------------------|--------------------------------|
| AE-BPW4F120P-20 |  |            | czarny / black / чёрный |                                |
| AE-BPW4S120P-10 |  | 4 x schuko | biały / white / белый   |                                |
| AE-BPW4S120P-20 |  |            | czarny / black / чёрный |                                |

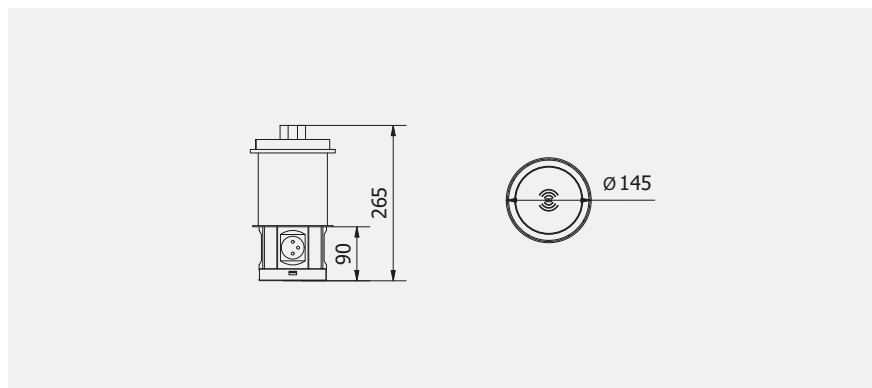

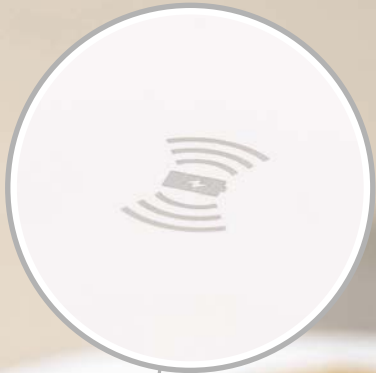

Gniazdo meblowe wpuszczone CAMINO  
 Recessed power socket CAMINO  
 Мебельная розетка врезная CAMINO



AE-BPW2FCAM-20



AE-BPW2FCAM-10

| AE-BPW2FCAM-20 | USB-A + USB-C<br>DC5V 3A (max 15,0W)<br>DC9V 2A (MAX. 18,0W)<br>DC12V 1.5A (MAX. 18,0W) | 2 x french | czarny / black / чёрный | aluminium tworzywo<br>aluminium plastic<br>алюминий пластик |
|----------------|---|------------|-------------------------|---|
| AE-BPW2SCAM-20 |   | 2 x schuko |                         |   |
| AE-BPW2FCAM-10 |   | 2 x french | biały / white / белый   |   |
| AE-BPW2SCAM-10 |   | 2 x schuko |                         |   |

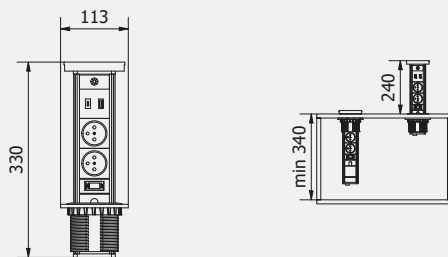





Gniazdo meblowe wpuszczane AVARO PLUS  
 Recessed power socket AVARO PLUS  
 Мебельная розетка врезная AVARO PLUS



AE-PB1FAVAP-10



AE-PB1SAVAP-10

| AE-PB1FAVAP-20 | USB-A + USB-C<br>DC5V 3A (max 15,0W)<br>DC9V 2A (MAX. 18,0W)<br>DC12V 1.5A (MAX. 18,0W) | 1 x french | czarny / black / чёрный | aluminium tworzywo<br>aluminium plastic<br>алюминий пластик |
|----------------|---|------------|-------------------------|---|
| AE-PB1SAVAP-20 |   | 1 x schuko |                         |   |
| AE-PB1FAVAP-53 |   | 1 x french | szary / gray / серый    |   |
| AE-PB1SAVAP-53 |   | 1 x schuko |                         |   |
| AE-PB1FAVAP-10 |   | 1 x french | biały / white / белый   |   |
| AE-PB1SAVAP-10 |   | 1 x schuko |                         |   |

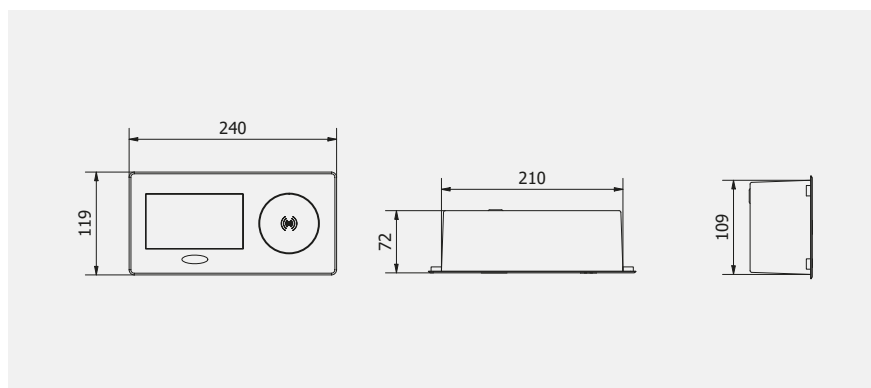



Gniazdo meblowe wpuszczane AVARO  
 Recessed power socket AVARO  
 Мебельная розетка врезная AVARO



AE-PB1FAVA-10



AE-PB1SAVA-10



|               |                                  |            |                         |   |
|---------------|----------------------------------|------------|-------------------------|---|
| AE-PB1FAVA-20 | USB A<br>DC5V 2A<br>(MAX. 10,0W) | 1 x french | czarny / black / чёрный | aluminium tworzywo,<br>aluminium plastic,<br>алюминий пластик |
| AE-PB1SAVA-20 |                                  | 1 x schuko |                         |   |
| AE-PB1FAVA-53 |                                  | 1 x french | szary / gray / серый    |   |
| AE-PB1SAVA-53 |                                  | 1 x schuko |                         |   |
| AE-PB1FAVA-10 |                                  | 1 x french | biały / white / белый   |   |
| AE-PB1SAVA-10 |                                  | 1 x schuko |                         |   |

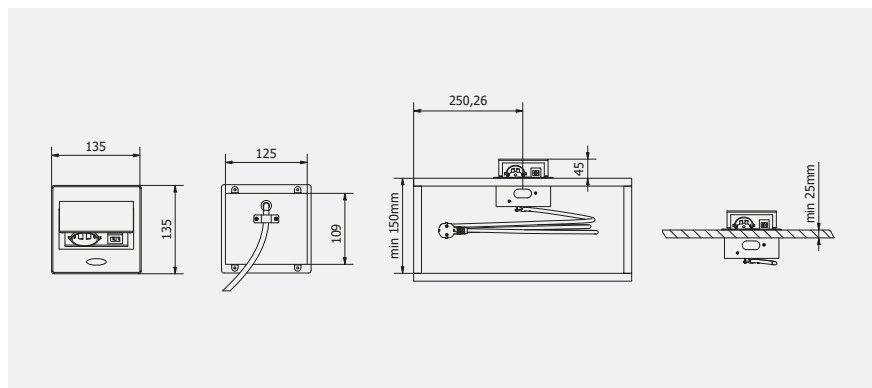



Gniazdo meblowe wpuszczane CHARGER  
 Recessed power socket CHARGER  
 Мебельная розетка врезная CHARGER



AE-BPW1S2UCH-80

AE-BPW1U2UCH-80

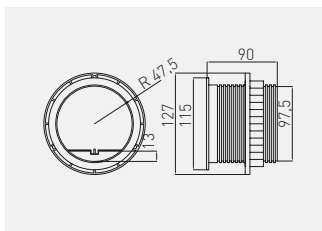

|                 |            |                                  |                                   |
|-----------------|------------|----------------------------------|-----------------------------------|
|                 |            |                                  |                                   |
| AE-BPW1S2UCH-80 | 1 x schuko | srebrny<br>silver<br>серебристый | tworzywo<br>plastic<br>пластмасса |
| AE-BPW1U2UCH-80 | 1 x french |                                  |                                   |



Gniazdo meblowe wpuszczane CHARGER MINI  
 Recessed power socket CHARGER MINI  
 Мебельная розетка врезная CHARGER MINI

360°



AE-BPW1S1UCH-53

AE-BPW1U1UCH-53

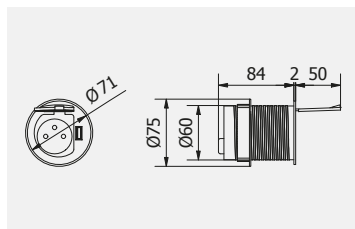

|                 |            |                                   |                                   |
|-----------------|------------|-----------------------------------|-----------------------------------|
|                 |            |                                   |                                   |
| AE-BPW1U1UCH-53 | 1 x french | aluminium<br>aluminum<br>алюминий | tworzywo<br>plastic<br>пластмасса |
| AE-BPW1S1UCH-53 | 1 x schuko |                                   |                                   |





Gniazdo meblowe wpuszczane SLIDE  
 Recessed power socket SLIDE  
 Мебельная розетка врезная SLIDE

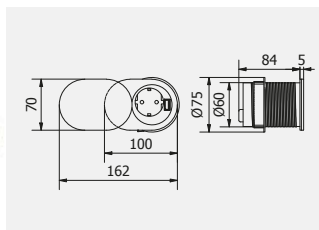

AE-BPW1U1UCH-51

AE-BPW1S1UCH-51

|                 |            |               |                                    |   |
|-----------------|------------|---------------|------------------------------------|---|
|                 |            |               |                                    |   |
| AE-BPW1U1UCH-51 | 1 x french | USB 5V / 2,4A | aluminium<br>aluminium<br>алюминий | tworzywo plastic<br>plastic<br>пластмасса |
| AE-BPW1S1UCH-51 | 1 x schuko |               |                                    |   |



Gniazdo meblowe wpuszczane COMFORT  
 Recessed power socket COMFORT  
 Мебельная розетка врезная COMFORT

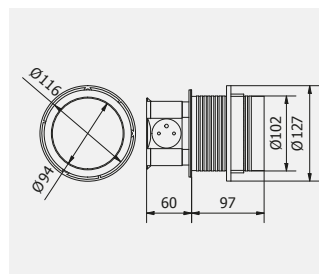

AE-BPW3S100U-53

AE-BPW4U100-53

|                 |            |                   |                                    |   |
|-----------------|------------|-------------------|------------------------------------|---|
|                 |            |                   |                                    |   |
| AE-BPW4U100-53  | 4 x french | 5V USB<br>max. 2A | aluminium<br>aluminium<br>алюминий | aluminium, tworzywo<br>aluminium, plastic<br>алюминий, пластмасса |
| AE-BPW4S100-53  | 4 x schuko |                   |                                    |   |
| AE-BPW3U100U-53 | 3 x french |                   |                                    |   |
| AE-BPW3S100U-53 | 3 x schuko |                   |                                    |   |



Gniazdo meblowe wpuszczane okrągłe  $\varnothing 100$   
 Round recessed power socket  $\varnothing 100$   
 Мебельная розетка врезная круглая  $\varnothing 100$

360°



AE-BPW3GU-80



AE-BPW3GU-20

|              |     |            |                                |   |
|--------------|-----|------------|--------------------------------|---|
|              |     |            |                                |   |
| AE-BPW3GU-20 | 100 | 3 x french | czarny / black / чёрный        | aluminium, tworzywo<br>aluminium, plastic<br>алюминий, пластмасса |
| AE-BPW3GU-80 |     |            | srebrny / silver / серебристый |   |
| AE-BPW3GS-20 |     | 3 x schuko | czarny / black / чёрный        |   |
| AE-BPW3GS-80 |     |            | srebrny / silver / серебристый |   |

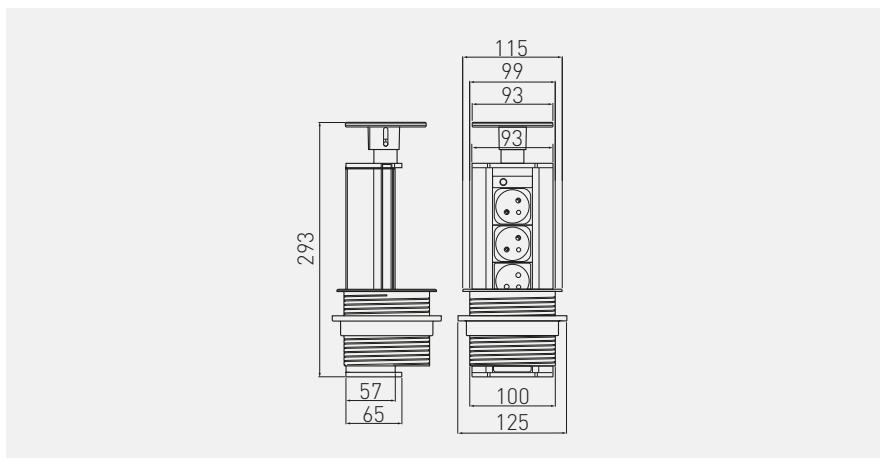





Gniazdo meblowe wpuszczane okrągłe ø60  
 Round recessed power socket ø60  
 Мебельная розетка врезная круглая ø60

360°



AE-BPW3U60-20



AE-BPW3U60-80



AE-BPW3U60U-20



AE-BPW3U60U-80

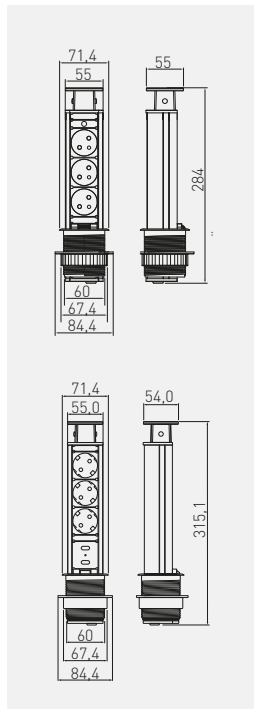

|                |    |            |   |                                |  |                                |
|----------------|----|------------|---|--------------------------------|--|--------------------------------|
| AE-BPW3U60-20  | 60 | 3 x french | - | czarny / black / чёрный        | aluminium,<br>tworzywo<br>aluminium,<br>plastic<br>алюминий,<br>пластмасса |                                |
| AE-BPW3U60-80  |    |            |   | srebrny / silver / серебристый |  |                                |
| AE-BPW3S60-20  |    | 3 x schuko |   | czarny / black / чёрный        |  |                                |
| AE-BPW3S60-80  |    |            |   | srebrny / silver / серебристый |  |                                |
| AE-BPW3U60U-20 |    | 3 x french |   | 5V USB<br>max. 2A              |  | czarny / black / чёрный        |
| AE-BPW3U60U-80 |    |            |   |                                |  | srebrny / silver / серебристый |
| AE-BPW3S60U-20 |    | 3 x schuko |   |                                |  | czarny / black / чёрный        |
| AE-BPW3S60U-80 |    |            |   |                                |  | srebrny / silver / серебристый |



Gniazdo meblowe wpuszczane prostokątne  
Rectangular recessed power socket  
Мебельная розетка врезная прямоугольная



|              |       |            |                                    |   |  |
|--------------|-------|------------|------------------------------------|---|--|
|              |       |            |                                    |   |  |
| AE-PB03GS-53 | -     | 3 x schuko | aluminium<br>aluminium<br>алюминий | stal, tworzywo<br>steel, plastic<br>сталь, пластмасса |  |
| AE-PB03GS-20 | -     | 3 x schuko |                                    |   |  |
| AE-PB03GS-10 | -     | 3 x schuko |                                    |   |  |
| AE-PB03GU-53 | -     | 3 x french |                                    |   |  |
| AE-PBC3GU-53 | 1,5 m | 3 x french | czarny / black / чёрный            |   |  |
| AE-PBC3GU-20 | 1,5 m | 3 x french | biały / white / белый              |   |  |
| AE-PBC3GU-10 | 1,5 m | 3 x french |                                    |   |  |



Gniazdo meblowe wpuszczane prostokątne  
Rectangular recessed power socket  
Мебельная розетка врезная прямоугольная



|               |            |  |                                  |   |  |
|---------------|------------|--|----------------------------------|---|--|
|               |            |  |                                  |   |  |
| AE-PBU02GS-10 |            |  | biały / white / белый            | stal, tworzywo<br>steel, plastic<br>сталь, пластмасса |  |
| AE-PBU02GS-20 | 2 x schuko |  | czarny / black / чёрный          |   |  |
| AE-PBU2GU-10  | 2 x french |  | biały / white / белый            |   |  |
| AE-PBU2GU-20  |            |  | czarny / black / чёрный          |   |  |
| AE-PBU2GU-53  |            |  | aluminium / aluminium / алюминий |   |  |



Gniazdo meblowe wpuszczane SOFT  
 Recessed power socket SOFT  
 Мебельная розетка врезная SOFT



360°



AE-PBSC3GS-20



AE-PBSUC2GS-20



AE-PBSC3GS-53



AE-PBSUC2GS-53



|                 |            |                                |                                |   |
|-----------------|------------|--------------------------------|--------------------------------|---|
| AE-PBSC3GS-10   | 3 x schuko | -                              | biały, white, белый            | stal, tworzywo<br>steel, plastic<br>сталь, пластмасса |
| AE-PBSC3GS-20N  |            |                                | czarny, black, черный          |   |
| AE-PBSC3GS-53   |            |                                | aluminium, aluminium, алюминий |   |
| AE-PBSC3GU-10   | 3 x french | biały, white, белый            |                                |   |
| AE-PBSC3GU-20N  |            | czarny, black, черный          |                                |   |
| AE-PBSC3GU-53   |            | aluminium, aluminium, алюминий |                                |   |
| AE-PBSUC2GS-10  | 2 x schuko | 5V USB<br>max 2A               | biały, white, белый            |   |
| AE-PBSUC2GS-20N |            |                                | czarny, black, черный          |   |
| AE-PBSUC2GS-53  |            |                                | aluminium, aluminium, алюминий |   |
| AE-PBSUC2GU-10  | 2 x french | biały, white, белый            |                                |   |
| AE-PBSUC2GU-20N |            | czarny, black, черный          |                                |   |
| AE-PBSUC2GU-53  |            | aluminium, aluminium, алюминий |                                |   |





Gniazdo meblowe przepustowe z USB  
Through-desk power socket with USB  
Мебельная розетка проходная с USB

360°



AE-PBC3GS-53BKS



AE-PBC3GS2U-53BKS

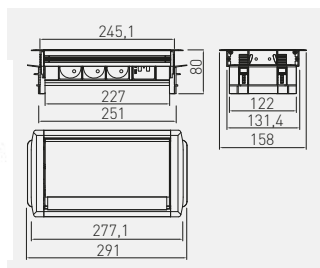

|                   |            |                   |                                    |   |
|-------------------|------------|-------------------|------------------------------------|---|
|                   |            |                   |                                    |   |
| AE-PBC3GS-53BKS   | 3 x schuko | -                 | aluminium<br>aluminium<br>алюминий | aluminium, tworzywo<br>aluminium, plastic<br>алюминий, пластмасса |
| AE-PBC3GS2U-53BKS | 3 x french | 5V USB<br>max. 2A |                                    |   |



Gniazdo meblowe bez kasety  
Furniture power socket without housing  
Мебельная розетка без корпуса



AE-PBC3GS-51BK



AE-PBC3GU-51BK

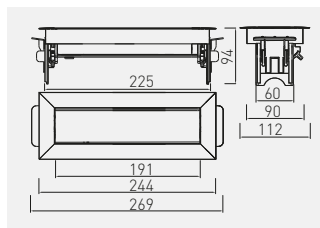

|                |            |  |  |
|----------------|------------|--|--|
|                |            |  |  |
| AE-PBC3GS-51BK | 3 x schuko | stal szczotkowana<br>brushed steel     | stal, aluminium, tworzywo<br>steel, aluminium, plastic |
| AE-PBC3GU-51BK | 3 x french | шлифованная сталь<br>шлифованная сталь | сталь, алюминий, пластмасса                            |







Gniazdo meblowe kątowe  
 Corner furniture power socket  
 Мебельная розетка угловая









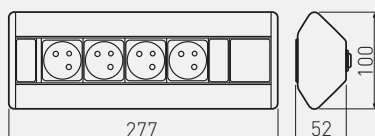





























AE-PBKT4S-80

AE-PBKT3U2U-80

|  |  |  |  |  |
|---|---|---|---|---|
| AE-PBKT4U-80  | 4 x french  | -   | -   | aluminium, tworzywo<br>aluminium, plastic<br>алюминий, пластмасса                 |
| AE-PBKT4S-80  | 4 x schuko  |   |   |   |
| AE-PBKT3U2U-80  | 4 x french  | 5V USB<br>max. 2A   | srebrny<br>silver<br>серебристый  |   |
| AE-PBKT3S2U-80  | 4 x schuko  |   |   |   |



## OBJAŚNIENIA IKON / ICONS EXPLANATION / ОПИСАНИЕ ИКОНОК

|   |  |   |  |   |  |
|---|--|---|--|---|--|
|    | indeks<br>index<br>индекс                            |    | szerokość<br>width<br>ширина   |    | dotatkowe informacje<br>additional information<br>дополнительная информация              |
|    | wysokość prowadnika<br>guide height<br>высота чашки  |    | wymiary (mm)<br>dimensions (mm)<br>размеры (мм)                                      |    | stopień ochrony IP<br>protection rating IP<br>степень защиты IP                          |
|    | wkręty zwykłe<br>wood screws<br>саморезы             |    | wymiary (m)<br>dimensions (m)<br>размеры (м)   |    | odległość cięcia<br>cutting distance<br>длина отрезка                                    |
|    | euro wkręty<br>euro screws<br>евро саморезы          |    | grubość<br>thickness<br>толщина  |    | szerokość taśmy<br>strip width<br>ширина ленты   |
|    | pokrycie<br>finish<br>покрытие                       |    | szerokość zewnętrzna szafki<br>outside width of the cabinet<br>наружная ширина ящика |    | USB<br>USB<br>USB  |
|    | kolor<br>color<br>цвет                               |    | materiał<br>material<br>материал   |    | rodzaj gniazda<br>socket type<br>тип гнезда  |
|    | obciążenie<br>load<br>нагрузка                       |    | wysuw<br>extension<br>выдвижение   |    | moc<br>power<br>номинальный режим  |
|    | pojemność<br>capacity<br>емкостельность              |    | kształt<br>shape<br>форма  | Akcesoria meblowe<br>Furniture accessories<br>Мебельная фурнитура                   |  |
|   | siła oporu<br>strenght<br>сила опоры                 |   | strumień świetlny<br>luminous flux<br>номинальный световой поток                     |   | zawias nakładany<br>overlay door<br>накладная петля                                      |
|  | długość<br>length<br>длина                           |  | długość przewodu<br>wire length<br>длина провода                                     |  | zawias bliźniaczy<br>twin overlay<br>полунакладная петля                                 |
|  | rozstaw<br>size<br>межцентровое расстояние           |  | ilość diod<br>number of diodes<br>количество диод                                    |  | zawias wpuszczany<br>inset door<br>вкладная петля  |
|  | wysokość<br>height<br>высота                         |  | kolor obudowy<br>housing color<br>цвет корпуса                                       |  | zawias kątowy<br>corner hinge<br>угловая петля   |
|  | strata wysuwu<br>extension loss<br>потеря выдвижения |  | temperatura barwowa światła<br>color temperature<br>температура оттенка света        |  | zawias o szerokim kącie otwarcia<br>wide angle hinge<br>петля с широким углом открывания |
|  | średnica<br>diameter<br>диаметр                      |  | kąt świecenia<br>beam angle<br>угол свечения   |  | zawias równoległy<br>parallel hinge<br>петля под фальшьпанель (равнолежащая)             |



|  |   |  |  |  |   |
|--|---|--|--|--|---|
|  | zawias równoległy nakładany<br>parallel hinge for overlay door<br>петля накладная под фальшпанель                                   |  | SLIDE-ON<br>sposób montażu slide-on<br>slide-on mounting<br>надвижной монтаж slide-on                      |  | PUSH<br>push-to-open  |
|  | zawias uzupełniający<br>complementary hinge<br>петля для складных дверей  |  | SLOW<br>zawias z mechanizmem cichego domykania<br>hinge with soft closing<br>петля с доводчиком Soft Close |  | FULL<br>pełny wysuw<br>full extension<br>полное выдвижение  |
|  | regulacja<br>adjustment<br>регулировка  |  | zawias ze sprężyną dociągającą<br>hinge with closing spring<br>петля с пружинной пружиной                  |  | szuflada standard<br>standard drawer<br>стандартный ящик  |
|  | działanie jednostopniowe<br>single action hinge<br>одношаговая петля  |  | zawias samootwierający<br>self-opening hinge<br>петля самооткрывающаяся                                    |  | szuflada zlewozmywakowa<br>under sink drawer<br>ящик под мойку  |
|  | działanie dwustopniowe<br>double action hinge<br>двухшаговая петля  |  | zawias bez sprężyny<br>hinge without spring<br>петля без пружины   |  | szuflada narożna<br>corner drawer<br>ящик угловой   |
|  | SPECIAL<br>zawias do zastosowań specjalnych<br>special hinge<br>петля для специальных конструкций                                   |  | A<br>szuflada niska<br>low drawer<br>низкий ящик   |  | szuflada standardowa<br>standard drawer<br>стандартный ящик   |
|  | Ø 35 mm<br>średnica puszki<br>hinge cup diameter<br>диаметр чашки   |  | B<br>szuflada średnia<br>medium drawer<br>средний ящик   |  | szuflada wewnętrzna<br>inner drawer<br>внутренний ящик  |
|  | 45 mm<br>rozstaw otworów puszek<br>hinge cup drilling spacing<br>межцентровое расстояние<br>отверстий на чашке                      |  | C<br>szuflada wysoka<br>high drawer<br>высокий ящик  |  | przewodnica dolnego montażu<br>under mount drawer<br>направляющая нижнего монтажа                         |
|  | montaż puszek na wkręty do drewna<br>wood screw hinge cup mounting<br>монтаж чашки на саморезы по дереву                            |  | regulacja pion i poziom<br>vertical and horizontal adjustment<br>регулировка по ширине и высоте            |  | przewodnica kulkowa<br>ball-bearing slide<br>шариковая направляющая                                       |
|  | montaż przewodnika na wkręty do drewna<br>wood screw mounting plate installation<br>установка ответной планки на саморезы по дереву |  | opcja wypięcia<br>release option<br>снятие ящика без инструментов  |  | przewodnica rolkowa<br>roller slide<br>роликовая направляющая   |
|  | montaż przewodnika na wkręty euro<br>euro screw mounting plate installation<br>установка ответной планки на евровинты               |  | H=83<br>wysokość boku MB Square<br>drawer side height MB Square<br>высота боковой стенки MB Square         |  | metalbox<br>metalbox<br>металбок  |
|  | montaż przewodnika na kolki<br>dowel mount hinge<br>монтаж чашки на саморезы с дюбелями   |  | H=83<br>wysokość boku MB<br>drawer side height MB<br>высота боковой стенки MB                              |  | SLOW<br>cichy domyk<br>quiet shut<br>бесшумное закрывание   |
|  | regulacja mimośrodowa<br>eccentric adjustment<br>эксцентриковая регулировка   |  | H=95<br>wysokość boku AXIS<br>drawer side height AXIS<br>высота боковой стенки AXIS                        |  | SELF CLOSING<br>samodociąg<br>self closing<br>доводчик  |
|  | x 100<br>pakowanie<br>packing<br>упаковка   |  | 3D<br>dostępna bryła 3D<br>3D model available<br>есть 3D модель  |  | montaż nasuwany ze sprzęgłem<br>push mounting with locking device<br>надвижной монтаж с креплением фасада |
|  | CLIP-ON<br>sposób montażu clip-on<br>clip-on mounting<br>быстрый монтаж clip-on   |  | CERTIFICATE<br>60,000<br>trwałość<br>tested durability<br>кол-во циклов откр./закр.                        |  | montaż nakładany<br>put on mounting<br>накладной монтаж   |



**PARTIAL**  
częściowy wysuw  
partial extension  
неполное выдвижение



max = 16 mm  
max grubość płyty  
max board thickness  
макс. толщина плиты



0-2,5 mm  
regulacja pionowa  
vertical adjustment  
регулировка по ширине



±1,5 mm  
regulacja pozioma  
horizontal adjustment  
регулировка по высоте



0-3 mm  
regulacja głębokości  
depth adjustment  
регулировка по глубине



**GLASS**  
zastosowanie do szkła  
appliance glass  
применение к стеклу



**GLASS**  
4 mm  
zastosowanie do szkła 4 mm  
appliance glass 4 mm  
применение к стеклу 4 mm



**WOOD**  
zastosowanie do płyty  
appliance panel  
применение к плите



**WOOD**  
18mm  
zastosowanie do płyty 18 mm  
appliance panel 18 mm  
применение к плите 18 mm



**WOOD**  
12mm  
zastosowanie do płyty 12 mm  
appliance panel 12 mm  
применение к плите 12 mm



**WOOD**  
16mm  
zastosowanie do płyty 16 mm  
appliance panel 16 mm  
применение к плите 16 mm



**WOOD**  
10mm  
zastosowanie do płyty 10 mm  
appliance panel 10 mm  
применение к плите 10 mm



**WOOD**  
≥16mm  
zastosowanie do płyty ≥16 mm  
appliance panel ≥16 mm  
применение к плите ≥16 mm



**WOOD**  
16-22mm  
zastosowanie do płyty 16 - 22 mm  
appliance panel 16 - 22 mm  
применение к плите 16 - 22 mm



**WOOD**  
16-28mm  
zastosowanie do płyty 16 - 28 mm  
appliance panel 16 - 28 mm  
применение к плите 16 - 28 mm

## Oświetlenie meblowe Furniture lighting Мебельное освещение



klasa energetyczna  
energy efficiency class  
класс энергоэффективности



zasilanie napięciem przemiennym 220-240 V  
220-240 V power supply AC  
напряжение питания 220-240 В переменный ток



zasilanie napięciem stałym 12 V  
12 V power supply DC  
напряжение питания 12 В постоянный ток



zasilanie napięciem 12 V  
12 V power supply  
напряжение питания 12 В



napięcie wyjściowe  
output voltage  
напряжение на выходе



moc źródła światła lub urządzenia  
light bulb or fixture power  
мощность лампы или устройства



maksymalne dopuszczalne obciążenie  
max permissible load  
максимально допустимая нагрузка



kąt świecenia  
beam angle  
угол свечения



rodzaj diody  
types of diode  
тип диодов



ilość diod  
number of diodes  
количество диодов



długość przewodu  
wire length  
длина провода



długość przewodu z wtyczką  
length of cord with plug  
длина провода с вилкой



długość przewodu ze złączką  
length of cord with connector  
длина провода с соединителем



rodzaj złączki  
type of connector  
тип соединителя



rodzaj złączki  
type of connector  
тип соединителя



temperatura pracy  
working temperature  
рабочая температура



rodzaj złączki  
type of connector  
тип соединителя



gniazdo USB  
USB port  
USB – порт



stopień ochrony IP  
international protection marking  
пылевлагозащита IP



maksymalne obciążenie gniazd USB  
max load USB ports  
максимальная нагрузка портов USB



współczynnik oddawania barw  
colour rendering index  
индекс цветопередачи



gniazdo UK  
UK socket  
гнездо UK



współczynnik mocy  
power factor  
коэффициент мощности



ethernet  
ethernet port  
ethernet – порт



liczb cykli wł./wytł.  
switching cycle  
количество циклов вкл./выкл.



nie współpracuje ze ściemniaczami  
non-dimmable  
нет возможности подключения диммера



włącznik dotykowy ściemniany  
dimmable touch switch  
выключатель с регулятором яркости



współpracuje ze ściemniaczami  
dimmable  
есть возможность подключения диммера



oprawa z włącznikiem  
fixture with switch  
светильник с выключателем



montaż na ścianie / suficie  
application: indoor / ceiling mounted  
монтаж на стене / потолке



sterowanie pilotem (IR/RF)  
remote control (IR/RF)  
управление с помощью пульта (ИР/РФ)



rekomenowana odległość montażu od powierzchni  
recommended mounting distance from surfaces  
рекомендуется монтаж устройства на расстоянии



włącznik bezdotykowy dwubiegowy  
two-pole touchless switch  
бесконтактный переключатель / двухфункциональный



średnica otworu montażowego  
mounting hole diameter  
монтажное отверстие диаметром



włącznik do szafy / jednobiegowy  
single-pole touchless switch  
переключатель для шкафов / однофункциональный



akumulator  
battery  
аккумулятор



zasięg czujki ruchu  
range of motion sensor  
площадь действия сенсора



Maksymalne obciążenie na jeden kanał  
Maximum load per channel  
Максимальная нагрузка на один канал



czas pracy  
nominal lifetime  
время работы



Częstotliwość pracy pilota  
Remote control frequency  
Частота работы пульта



czas włączania  
starting time (max)  
время включения



trzonek źródła światła G4  
base type G4  
тип цоколя G4



Maksymalna rozpraszana moc źródeł światła dla profilu rozgrzanego do maksymalnie 65 stopni C, dla wersji z kloszem.  
Maximal dissipated power of lamps for heated profiles to 65°C, when applied with lampshades.  
Максимальная рассеиваемая мощность источников света для нагреваемого профиля до максимум 65°C, для версии с абажуром.

KOLORY  
COLORS  
ЦВЕТА



10  
biały  
white  
белый



80  
srebrny  
silver  
серебристый



14  
antyczna miedź  
antique copper  
античная медь



10M  
biały mat  
white matt  
белый матовый



7  
antyczne srebro  
antique silver  
античное серебро



20  
czarny  
black  
чёрный



mleczny  
milk  
молочный



19  
szary mat  
grey matt  
серый матовый



20M  
czarny mat  
black matt  
чёрный матовый



CS  
kremowy  
ecru  
экрю



2, 52  
satyna  
satin  
сатин



58  
wenge  
venge  
венге



1, 40  
chrom  
chrome  
хром



6, 51  
stal szcztokowana  
brushed steel  
шлифованная сталь



3  
mosiądz  
brass  
латунь



5, 53  
aluminium  
aluminium  
алюминий



11  
tytan szcztokowany  
brushed titanium  
шлифованный титан



4  
antyczny mosiądz  
antique brass  
античная латунь



30  
szary  
gray  
серый



12  
czarny chrom  
black chrome  
чёрный хром



9  
antyczny mosiądz  
szcztokowany  
antique brushed brass  
античная шлифованная латунь



ocynk  
zinc - plated  
оцинковка



13  
tytan  
titanium  
титан



16  
złoty mosiądz  
golden brass  
золотая латунь



22  
kość stoniowa  
ivory  
слоновая кость



52  
wiśnia  
cherry  
вишня



RZ  
różowy  
pink  
розовый



17  
brąz  
bronze  
коричневый



42  
grusza  
pear  
груша



PM  
pomarańczowy  
orange  
оранжевый



50  
beż  
beige  
кремовый



30  
brąz  
brown  
коричневый



15  
miedź  
copper  
медь



7, 31, 732  
ciemny brąz  
dark brown  
темно-коричневый



44  
buk  
beech  
бук



61  
ciemny mahoń  
dark mahogany  
темное красное дерево



41  
olcha  
alder  
ольха



20, 48, 731  
mahoń  
mahogany  
красное дерево



43  
jasny brąz  
light brown  
светло-коричневый



NB  
niebieski  
blue  
синий



51  
calvados  
calvados  
кальвадос



ZL  
zielony  
green  
зеленый

**Klasa ochrony na pył, ciała stałe i wodę**  
**Dust, solids & water ingress protection rating**  
**Класс защиты от пыли, твердых тел и воды**



| IP       | Stopień ochrony I<br>Protection rating I<br>Степень защиты I  |
|----------|---|
| <b>0</b> | Brak ochrony<br>None<br>Отсутствие защиты   |
| <b>1</b> | Ochrona przed ciałami obcymi statymi o wielkości ponad 50 mm.<br>Protection against ingress of > 50 mm bodies.<br>Защита от попадания инородных твердых тел размером более 50 мм. |
| <b>2</b> | Ochrona przed ciałami statymi przekraczającymi 12 mm.<br>Protection against ingress of > 12 mm bodies.<br>Защита от попадания инородных твердых тел размером более 12 мм.         |
| <b>3</b> | Ochrona przed ciałami statymi przekraczającymi 2,5 mm.<br>Protection against ingress of > 2.5 mm bodies.<br>Защита от попадания инородных твердых тел размером более 2,5 мм.      |
| <b>4</b> | Ochrona przed ciałami statymi przekraczającymi 1 mm.<br>Protection against ingress of > 1 mm bodies.<br>Защита от попадания инородных твердых тел размером более 1 мм.            |
| <b>5</b> | Pyłoodporność<br>Protection against ingress of dust<br>Пылестойкость  |
| <b>6</b> | Pyłoszczelność<br>Dustproof<br>Пылестойкость  |

| IP       | Stopień ochrony II<br>Protection rating II<br>Степень защиты II  |
|----------|--|
| <b>0</b> | Brak ochrony<br>None<br>Отсутствие защиты  |
| <b>1</b> | Ochrona przed pionowo wpadającymi kroplami wody.<br>Protection against dripping water (vertically falling drops).<br>Защита от вертикально падающих капель воды.       |
| <b>2</b> | Ochrona przed kroplami wody przy przechyleniu do 15°.<br>Protection against dripping water when tilted up to 15°.<br>Защита от капель воды, падающих под углом до 15°. |
| <b>3</b> | Ochrona przed rozpyloną wodą<br>Protection against spraying water.<br>Защита от распыленной воды.  |
| <b>4</b> | Ochrona przed bryzgami wody<br>Protection against splashing of water.<br>Защита от брызг воды.   |
| <b>5</b> | Ochrona przed strugami wody<br>Protection against water jets<br>Защита от струй воды   |
| <b>6</b> | Ochrona przed falami<br>Protection against powerful water jets (waves)<br>Защита от волн   |
| <b>7</b> | Ochrona przed zanurzeniem<br>Protection against immersion<br>Защита от погружения  |
| <b>8</b> | Ochrona przed głębokim zanurzeniem<br>Protection against deep immersion<br>Защита от глубокого погружения  |

## Klasa ochronności przed porażeniem elektrycznym

### Electric shock protection class

### Класс защиты от поражения электрическим током

| Klasa bezpieczeństwa<br>Safety class<br>Класс безопасности | Symbol<br>Symbol<br>Символ  | Wyjaśnienie<br>Definition<br>Пояснение   |
|--|---|--|
| 0  | Brak<br>None<br>Нет<br>Keine<br>Nincs   | <p>Ochronę przed porażeniem elektrycznym stanowi izolacja podstawowa. W przypadku uszkodzenia izolacji ochronę przeciwporażeniową powinny zapewnić odpowiednio korzystne warunki środowiskowe oraz położenie urządzenia poza dotykiem bezpośrednim.</p> <p>The protection against electric shock relies on basic insulation only. In the event of insulation failure, electric shock protection shall be assured by suitably favourable environmental conditions and locating the equipment beyond the reach of direct touch.</p> <p>Защиту от поражения электрическим током обеспечивает основная изоляция. В случае повреждения изоляции защиту от поражения электрическим током должны обеспечить соответствующие благоприятные условия окружающей среды и размещение оборудования вне зоны прямого контакта.</p> |
| I  |    | <p>W urządzeniach z I klasą ochronności bezpieczeństwo zapewnione jest przez połączenie wszystkich czynnych przewodzących elementów z przewodem ochronnym lub bezpośrednio z uziemieniem.</p> <p>Class I equipment provides protection by connecting all live conductive parts to a protective wire or directly to earth.</p> <p>В устройствах с I классом защиты безопасность обеспечивается посредством объединения всех действующих проводящих элементов с защитным проводом или непосредственно с заземлением.</p>   |
| II   |  | <p>W urządzeniach z II klasą ochronności bezpieczeństwo zapewnione jest przez zastosowanie izolacji podwójnej lub wzmocnionej, której w danych warunkach środowiskowych i przy napięciu znamionowym uważa się nie do przebicia.</p> <p>Class II equipment provides protection by the use of double or strengthened insulation, which is deemed breakdown-proof under given environmental conditions at the rated voltage.</p> <p>В устройствах с II классом защиты безопасность обеспечивается путем применения двойной или усиленной изоляции, которая в данных условиях окружающей среды и при номинальном напряжении считается непробиваемой.</p>   |
| III  |  | <p>Ochrona przeciwporażeniowa w urządzeniach z III klasy ochronności jest zapewniona przez obniżenie napięcia zasilania do wartości bezpiecznej w danych warunkach środowiskowych.</p> <p>Class III equipment protection against electric shock is provided by reduction of power voltage to a safe limit under given environmental conditions.</p> <p>Защита от поражения электрическим током в устройствах с III классом защиты обеспечивается снижением напряжения питания до безопасного в данных условиях окружающей среды значения.</p>  |

# Indeks

## A

|                 |               |                 |     |                   |     |                 |     |
|-----------------|---------------|-----------------|-----|-------------------|-----|-----------------|-----|
|                 |               | AE-BPW3S60U-80  | 618 | AE-PBC3GS2U-53BKS | 622 | AE-WBEZDPIR-10  | 589 |
| A-B63-32        | 514           | AE-BPW3S100U-53 | 615 | AE-PBC3GS-51BK    | 622 | AE-WDBP1-10N    | 586 |
| A-B63-40        | 513           | AE-BPW3U60-20   | 618 | AE-PBC3GS-53BKS   | 622 | AE-WDBP1-20N    | 586 |
| A-BUDP-SET      | 520           | AE-BPW3U60-80   | 618 | AE-PBC3GU-10      | 619 | AE-WDBP2CCT-10N | 586 |
| A-BUD-UB        | 520           | AE-BPW3U60U-20  | 618 | AE-PBC3GU-20      | 619 | AE-WDBP2CCT-20N | 586 |
| A-BUD-UG        | 520           | AE-BPW3U60U-80  | 618 | AE-PBC3GU-51BK    | 622 | AE-WDSB-10DIM   | 590 |
| A-BUD-UM        | 520           | AE-BPW3U100U-53 | 615 | AE-PBC3GU-53      | 619 | AE-WDSC-10DIM   | 590 |
| A-BUD-UP        | 520           | AE-BPW4F120P-10 | 606 | AE-PBKT3S2U-80    | 623 | AE-WLB01-10     | 592 |
| A-BUD-UR        | 520           | AE-BPW4F120P-20 | 606 | AE-PBKT3U2U-80    | 623 | AE-WLC01-20     | 592 |
| A-C18-300-S-05  | 502, 517, 518 | AE-BPW4S100-53  | 615 | AE-PBKT4S-80      | 623 | AE-WLIP44-15    | 593 |
| A-C18-300-S-10  | 502           | AE-BPW4S120P-10 | 606 | AE-PBKT4U-80      | 623 | AE-WLLAN1-10    | 594 |
| A-C18-300-S-20M | 502           | AE-BPW4S120P-20 | 606 | AE-PBSC3GS-10     | 620 | AE-WLLAN1-20    | 594 |
| A-C18-300-S-90  | 502           | AE-BPW4U100-53  | 615 | AE-PBSC3GS-20N    | 620 | AE-WLLAN1-90    | 594 |
| A-DPG-16        | 507           | AE-PB1FAVA-10   | 612 | AE-PBSC3GS-53     | 620 | AE-WLPR-60      | 592 |
| AE-BPW1FACP-10  | 604           | AE-PB1FAVA-20   | 612 | AE-PBSC3GU-10     | 620 | AE-WLPR-60P2    | 592 |
| AE-BPW1FACP-20  | 604           | AE-PB1FAVA-53   | 612 | AE-PBSC3GU-20N    | 620 | AE-WLSZN1-10    | 594 |
| AE-BPW1S1UCH-51 | 615           | AE-PB1FAVAP-10  | 610 | AE-PBSC3GU-53     | 620 | AE-WPDRW-00     | 591 |
| AE-BPW1S1UCH-53 | 614           | AE-PB1FAVAP-20  | 610 | AE-PBSUC2GS-10    | 620 | AE-ZLADLUX-40   | 601 |
| AE-BPW1S2UCH-80 | 614           | AE-PB1FAVAP-53  | 610 | AE-PBSUC2GS-20N   | 620 | AE-ZLADPOD-20   | 601 |
| AE-BPW1SACP-10  | 604           | AE-PB1SAVA-10   | 612 | AE-PBSUC2GS-53    | 620 | AE-ZUSB-20      | 600 |
| AE-BPW1SACP-20  | 604           | AE-PB1SAVA-20   | 612 | AE-PBSUC2GU-10    | 620 | A-H16-300-05    | 502 |
| AE-BPW1U1UCH-51 | 615           | AE-PB1SAVA-53   | 612 | AE-PBSUC2GU-20N   | 620 | A-H16-300-90    | 502 |
| AE-BPW1U1UCH-53 | 614           | AE-PB1SAVAP-10  | 610 | AE-PBSUC2GU-53    | 620 | A-H18-300-05    | 503 |
| AE-BPW1U2UCH-80 | 614           | AE-PB1SAVAP-20  | 610 | AE-PBU02GS-10     | 619 | A-H18-300-10    | 503 |
| AE-BPW2FCAM-10  | 608           | AE-PB1SAVAP-53  | 610 | AE-PBU02GS-20     | 619 | A-H18-300-20M   | 503 |
| AE-BPW2FCAM-20  | 608           | AE-PB2FPRES-10  | 602 | AE-PBU2GU-10      | 619 | A-H18-300-90    | 503 |
| AE-BPW2SCAM-10  | 608           | AE-PB2FPRES-20  | 602 | AE-PBU2GU-20      | 619 | A-HR10-235-05   | 505 |
| AE-BPW2SCAM-20  | 608           | AE-PB2FPRES-53  | 602 | AE-PBU2GU-53      | 619 | A-HR10-235-90   | 505 |
| AE-BPW3GS-20    | 616           | AE-PB2SPRES-10  | 602 | AE-WBBUNI-10DIM   | 590 | A-HR10-300-05   | 505 |
| AE-BPW3GS-80    | 616           | AE-PB2SPRES-20  | 602 | AE-WBCUNI-10DIM   | 590 | A-HR10-300-10   | 505 |
| AE-BPW3GU-20    | 616           | AE-PB2SPRES-53  | 602 | AE-WBEZDB-10S     | 588 | A-HR10-300-90   | 505 |
| AE-BPW3GU-80    | 616           | AE-PB03GS-10    | 619 | AE-WBEZDC-10S     | 588 | A-HR10-405-05   | 505 |
| AE-BPW3S60-20   | 618           | AE-PB03GS-20    | 619 | AE-WBEZDK15-10    | 588 | A-HR10-405-90   | 505 |
| AE-BPW3S60-80   | 618           | AE-PB03GS-53    | 619 | AE-WBEZD-NB       | 591 | A-HR10-600-05   | 505 |
| AE-BPW3S60U-20  | 618           | AE-PB03GU-53    | 619 | AE-WBEZDPIR-20    | 589 | A-HR10-600-90   | 505 |



|                  |     |                  |     |                  |     |                 |          |
|------------------|-----|------------------|-----|------------------|-----|-----------------|----------|
| A-HR10FL-300-05  | 505 | A-LD10-235-05    | 499 | A-LG10-405-90    | 498 | A-MEVO-300-90   | 494      |
| A-HR10FL-300-10  | 505 | A-LD10-235-90    | 499 | A-LG10-600-05    | 498 | A-MEVO-405-05   | 494      |
| A-HR10FL-300-20M | 505 | A-LD10-300-05    | 499 | A-LG10-600-90    | 498 | A-MEVO-405-10   | 494      |
| A-HR10FL-300-90  | 505 | A-LD10-300-10    | 499 | A-LG10FL-300-05  | 500 | A-MEVO-405-20M  | 494      |
| A-HR18-300-05    | 504 | A-LD10-300-20M   | 499 | A-LG10FL-300-10  | 500 | A-MEVO-405-90   | 494      |
| A-HR18-300-05RA  | 503 | A-LD10-300-90    | 499 | A-LG10FL-300-20M | 500 | A-MITO-PLUS     | 516      |
| A-HR18-300-10    | 504 | A-LD10-405-05    | 499 | A-LG10FL-300-90  | 500 | AM-KRZYK-KPL    | 102      |
| A-HR18-300-20M   | 504 | A-LD10-405-90    | 499 | A-LG18-170-05    | 496 | AM-MBSOFT-P2    | 159      |
| A-HR18-300-90    | 504 | A-LD10-600-05    | 499 | A-LG18-170-90    | 496 | AM-OAM-DL-GM-10 | 106      |
| A-HR18-300-90RA  | 503 | A-LD10-600-90    | 499 | A-LG18-235-05    | 496 | AM-OAM-DL-GM-30 | 106      |
| A-HR19-300-05    | 504 | A-LD10FL-300-05  | 501 | A-LG18-235-90    | 496 | AM-OAM-DL-GM-60 | 106      |
| A-HRS10-170-05   | 505 | A-LD10FL-300-10  | 501 | A-LG18-300-05    | 496 | AM-OAM-DL-MG-10 | 106      |
| A-HRS10-300-05   | 505 | A-LD10FL-300-20M | 501 | A-LG18-300-10    | 496 | AM-OAM-DL-MG-30 | 106      |
| A-HRS10-300-90   | 505 | A-LD10FL-300-90  | 501 | A-LG18-300-20M   | 496 | AM-OAM-DL-MG-60 | 106      |
| A-HRS10-405-05   | 505 | A-LD18-170-05    | 497 | A-LG18-300-90    | 496 | AM-OAM-KR-GM-10 | 106      |
| A-HRS10-600-05   | 505 | A-LD18-170-90    | 497 | A-LG18-405-05    | 496 | AM-OAM-KR-GM-30 | 106      |
| A-HRS18-170-05   | 504 | A-LD18-235-05    | 497 | A-LG18-405-10    | 496 | AM-OAM-KR-GM-60 | 106      |
| A-HRS18-170-90   | 504 | A-LD18-235-90    | 497 | A-LG18-405-90    | 496 | AM-OAM-KR-MG-10 | 106      |
| A-HRS18-235-05   | 504 | A-LD18-300-05    | 497 | A-LG18-600-05    | 496 | AM-OAM-KR-MG-30 | 106      |
| A-HRS18-235-90   | 504 | A-LD18-300-10    | 497 | A-LG18-600-90    | 496 | AM-OAM-KR-MG-60 | 106      |
| A-HRS18-300-05   | 504 | A-LD18-300-20M   | 497 | A-LG19-300-05    | 497 | AM-ODB000-10    | 102      |
| A-HRS18-300-90   | 504 | A-LD18-300-90    | 497 | AM-ADAP0A-10     | 103 | AM-ODB000-60    | 102      |
| A-HRS18-405-05   | 504 | A-LD18-405-05    | 497 | AM-ADAP0A-60     | 103 | AM-OWM-DL-GM-10 | 104      |
| A-HRS18-405-90   | 504 | A-LD18-405-90    | 497 | AM-ADAP0B-10     | 103 | AM-OWM-DL-GM-30 | 104      |
| A-HRS18-600-05   | 504 | A-LD18-600-05    | 497 | AM-ADAP0B-60     | 103 | AM-OWM-DL-GM-60 | 104      |
| A-HRS18-600-90   | 504 | A-LD18-600-90    | 497 | A-MEVO-170-05    | 494 | AM-OWM-DL-MG-10 | 104, 105 |
| A-K18-300-05     | 501 | A-LD19-300-05    | 498 | A-MEVO-170-10A   | 494 | AM-OWM-DL-MG-30 | 104      |
| A-K18-300-10     | 501 | A-LG4MOV-300-05  | 499 | A-MEVO-170-20M   | 494 | AM-OWM-DL-MG-60 | 104      |
| A-K18-300-20M    | 501 | A-LG10-170-05    | 498 | A-MEVO-170-90    | 494 | AM-OWM-KR-GM-10 | 104      |
| A-K18-300-90     | 501 | A-LG10-235-05    | 498 | A-MEVO-235-05    | 494 | AM-OWM-KR-GM-30 | 104      |
| A-KLP-4          | 512 | A-LG10-235-90    | 498 | A-MEVO-235-10A   | 494 | AM-OWM-KR-GM-60 | 104      |
| A-KLP-4-20       | 512 | A-LG10-300-05    | 498 | A-MEVO-235-20M   | 494 | AM-OWM-KR-MG-10 | 104      |
| A-KR-4           | 511 | A-LG10-300-10    | 498 | A-MEVO-235-90    | 494 | AM-OWM-KR-MG-30 | 104      |
| A-KR-4-20        | 511 | A-LG10-300-20M   | 498 | A-MEVO-300-05    | 494 | AM-OWM-KR-MG-60 | 104      |
| A-LD4MOV-300-05  | 500 | A-LG10-300-90    | 498 | A-MEVO-300-10A   | 494 | AM-PLA-DLU-0    | 105      |
| A-LD10-170-05    | 499 | A-LG10-405-05    | 498 | A-MEVO-300-20M   | 494 | AM-PL-DL-MAG    | 105      |

|                   |     |                   |     |                    |          |                 |     |
|-------------------|-----|-------------------|-----|--------------------|----------|-----------------|-----|
| A-MPRO-170-05     | 496 | A-R10FL-270-20M   | 490 | A-R18VIS-270-90    | 488      | A-T18-300-90    | 502 |
| A-MPRO-170-10     | 496 | A-R10FL-270-90    | 490 | A-R19NERO-300-05   | 489      | A-TDEV02-170-05 | 495 |
| A-MPRO-170-20M    | 496 | A-R10FORM-270-05  | 491 | A-R19NOVS-300-05   | 488      | A-TDEV02-170-90 | 495 |
| A-MPRO-170-90     | 496 | A-R10FORM-270-90  | 491 | A-RD-MITO          | 516      | A-TDEV02-235-05 | 495 |
| A-MPRO-235-05     | 496 | A-R10NOV-270-05   | 491 | A-RNOV2-270-05     | 487      | A-TDEV02-235-90 | 495 |
| A-MPRO-235-10     | 496 | A-R10NOV-270-10   | 491 | A-RNOV2-270-10     | 487      | A-TDEV02-300-05 | 495 |
| A-MPRO-235-20M    | 496 | A-R10NOV-270-20M  | 491 | A-RNOV2-270-20M    | 487      | A-TDEV02-300-90 | 495 |
| A-MPRO-235-90     | 496 | A-R10NOV-270-90   | 491 | A-RNOV2-270-90     | 487      | A-TDEV02-405-05 | 495 |
| A-MPRO-300-05     | 496 | A-R10TORO-270-05  | 492 | A-SG-MITO          | 516      | A-TDEV02-405-90 | 495 |
| A-MPRO-300-10     | 496 | A-R10TORO-270-90  | 492 | A-SN-ADSET         | 517, 518 | A-TDEV02-600-05 | 495 |
| A-MPRO-300-20M    | 496 | A-R10TRAFO-270-05 | 491 | A-SN-FSET          | 517      | A-TDEV02-600-90 | 495 |
| A-MPRO-300-90     | 496 | A-R10TRAFO-270-90 | 491 | A-SN-HSET1         | 518      | A-TDEV0-170-05  | 494 |
| A-MPRO-405-05     | 496 | A-R16ERG-220-05   | 486 | A-SN-K19-270-05    | 517, 518 | A-TDEV0-170-10  | 494 |
| A-MPRO-405-10     | 496 | A-R16ERG-230-50   | 486 | A-SN-LOFT-200-20MN | 521      | A-TDEV0-170-20M | 494 |
| A-MPRO-405-20M    | 496 | A-R16ERG-270-50   | 486 | A-SN-POZ           | 518      | A-TDEV0-170-90  | 494 |
| A-MPRO-405-90     | 496 | A-R16ERG-270-90   | 486 | A-SN-R19RIV-270-05 | 517, 518 | A-TDEV0-235-05  | 494 |
| AMR-BP-0715       | 107 | A-R18CARO-270-05  | 488 | A-SN-SDP-TU        | 519      | A-TDEV0-235-10  | 494 |
| AMR-BP-1003       | 107 | A-R18CARO-270-90  | 488 | A-SN-SOFT-25       | 517, 518 | A-TDEV0-235-20M | 494 |
| A-MSOFT-ADAPT     | 515 | A-R18COTE-270-05  | 489 | A-SN-SOFT-40       | 517, 518 | A-TDEV0-235-90  | 494 |
| A-MSOFT-RAMA      | 514 | A-R18COTE-270-90  | 489 | A-SN-TDS-405-00    | 517      | A-TDEV0-300-05  | 494 |
| AM-ZAT-A1-10      | 107 | A-R18ERG-270-05   | 486 | A-SN-TDT-405-00    | 518      | A-TDEV0-300-10  | 494 |
| A-PG-18           | 506 | A-R18ERG-270-20M  | 486 | A-SN-TG-405-00     | 517, 518 | A-TDEV0-300-20M | 494 |
| A-PGR-10          | 506 | A-R18ERG-270-90   | 486 | A-SO-48X4          | 510      | A-TDEV0-300-90  | 494 |
| A-PGR-10S         | 507 | A-R18GEO2-270-05  | 486 | A-SO-48X4-20       | 510      | A-TDEV0-405-05  | 494 |
| A-PGR-18          | 506 | A-R18LOCA-305-05  | 490 | A-SO-145X4         | 510      | A-TDEV0-405-10  | 494 |
| A-POZ-MITO        | 516 | A-R18LOCA-305-90  | 490 | A-SO-145X4-10      | 510      | A-TDEV0-405-20M | 494 |
| A-PTD 509         |     | A-R18NERO-270-05  | 489 | A-SO-145X4-20      | 510      | A-TDEV0-405-90  | 494 |
| A-PTG 509         |     | A-R18NERO-270-10  | 489 | A-SOFT-30          | 514      | A-TDEV0-600-05  | 494 |
| A-PW-RC-DOC       | 515 | A-R18NERO-270-20M | 489 | A-SOFT-30Z         | 514      | A-TDEV0-600-10  | 494 |
| A-R4MOV-270-05    | 490 | A-R18NERO-270-90  | 489 | A-SOFT-50          | 514      | A-TDEV0-600-20M | 494 |
| A-R10ARCO-270-05  | 492 | A-R18NOVS-270-05  | 487 | A-SOFT-50Z         | 514      | A-TDEV0-600-90  | 494 |
| A-R10ARCO-270-90  | 492 | A-R18NOVS-270-10  | 487 | A-SP-7X12          | 511      | A-TDPRO-170-05  | 495 |
| A-R10FALDA-270-05 | 492 | A-R18NOVS-270-20M | 487 | A-SP-48X7          | 510      | A-TDPRO-170-10  | 495 |
| A-R10FALDA-270-90 | 492 | A-R18NOVS-270-90  | 487 | A-SP-48X12         | 511      | A-TDPRO-170-20M | 495 |
| A-R10FL-270-05    | 490 | A-R18VIS-270-05   | 488 | A-T18-300-05       | 502      | A-TDPRO-170-90  | 495 |
| A-R10FL-270-10    | 490 | A-R18VIS-270-20M  | 488 | A-T18-300-10       | 502      | A-TDPRO-235-05  | 495 |

|                 |     |                    |     |                 |     |                   |          |
|-----------------|-----|--------------------|-----|-----------------|-----|-------------------|----------|
| A-TDPRO-235-10  | 495 | A-TG-BUD-300-00    | 520 | GP-0728-J4-R    | 386 | GZ-NORD-1-20M     | 347      |
| A-TDPRO-235-20M | 495 | A-TMITO-200-00     | 516 | GS-BERGA-1-01   | 361 | GZ-OLBIA-1-04     | 394      |
| A-TDPRO-235-90  | 495 | A-TMITO-200-05     | 516 | GS-BERGA-1-02   | 361 | GZ-PALER-1-07     | 388      |
| A-TDPRO-300-05  | 495 | A-TMITO-250-00     | 516 | GS-BERGA-1-05   | 361 | GZ-POINT-1-06     | 352      |
| A-TDPRO-300-10  | 495 | A-TMITO-250-05     | 516 | GS-BERGA-1-06   | 361 | GZ-POINT-1-18     | 352      |
| A-TDPRO-300-20M | 495 | A-TMITO-300-00     | 516 | GS-BERGA-1-10   | 361 | GZ-ROYAL3-1-10-03 | 396      |
| A-TDPRO-300-90  | 495 | A-TMITO-300-05     | 516 | GS-BERGA-1-12   | 361 | GZ-SONET-1-07     | 401      |
| A-TDPRO-405-05  | 495 | A-USZCZ-CHM4       | 513 | GS-BERGA-1-20M  | 361 | GZ-SONET-1-18     | 401      |
| A-TDPRO-405-10  | 495 | A-USZCZ-CHM4-20    | 513 | GS-BERGA-1-90   | 361 | GZ-SONET-1-20M    | 401      |
| A-TDPRO-405-20M | 495 | A-USZCZ-TDEVO2     | 513 | GZ-71C024-01    | 402 | GZ-SPOT-1-06      | 334      |
| A-TDPRO-405-90  | 495 | A-USZCZ-U4         | 512 | GZ-ARDEA-1-09   | 391 | GZ-SPOT-1-18      | 334      |
| A-TDPRO-600-05  | 495 | A-WD-EVO2          | 507 | GZ-CENTO-1-04   | 400 | GZ-SPOT-1-20M     | 334      |
| A-TDPRO-600-10  | 495 | A-WD-PRO           | 508 | GZ-CENTO-1-07   | 400 | GZ-STILO-1-18     | 355      |
| A-TDPRO-600-20M | 495 | A-WDR-EVO          | 508 | GZ-CENTO-1-14   | 400 | GZ-STILO-1-20M    | 355      |
| A-TDPRO-600-90  | 495 | A-WDR-PRO          | 509 | GZ-CENTO-1-20M  | 400 | GZ-TERNI-1-01     | 341, 362 |
| A-TG-170-05     | 493 | A-ZAC-WDEVO2       | 508 | GZ-CRPA20-01    | 405 | GZ-TERNI-1-02     | 362      |
| A-TG-170-10     | 493 | A-ZAT-TDEVO2       | 512 | GZ-CRPA25-01    | 405 | GZ-TERNI-1-05     | 362      |
| A-TG-170-20M    | 493 |                    |     | GZ-CRPA30-01    | 405 | GZ-TERNI-1-06     | 362      |
| A-TG-170-90     | 493 | <b>B</b>           |     | GZ-CRPA30-03    | 405 | GZ-TERNI-1-09     | 362      |
| A-TG-235-05     | 493 | BP-SLZIGW-10       | 451 | GZ-CRPA30-A1    | 405 | GZ-TERNI-1-10     | 362      |
| A-TG-235-10     | 493 | BP-SLZIGW-21       | 451 | GZ-CRPA40-01    | 405 | GZ-TERNI-1-12     | 362      |
| A-TG-235-20M    | 493 |                    |     | GZ-CRPB20-01    | 406 | GZ-TERNI-1-15     | 362      |
| A-TG-235-90     | 493 | <b>E</b>           |     | GZ-CRPB25-01    | 406 | GZ-TERNI-1-16     | 362      |
| A-TG-300-05     | 493 | EM-SBL065-01-A     | 228 | GZ-CRPB25-A1    | 406 | GZ-TERNI-1-20M    | 362      |
| A-TG-300-10     | 493 | EM-SBL100-01-A     | 228 | GZ-CRPB30-01    | 406 | GZ-UDINE-1-01     | 362      |
| A-TG-300-20M    | 493 | EM-SBL150-01-A     | 228 | GZ-CRPB30-03    | 406 | GZ-UDINE-1-02     | 362      |
| A-TG-300-90     | 493 |                    |     | GZ-CRPB30-A1    | 406 | GZ-UDINE-1-05     | 362      |
| A-TG-405-05     | 493 | <b>G</b>           |     | GZ-CRPB40-01    | 406 | GZ-UDINE-1-06     | 362      |
| A-TG-405-10     | 493 | GA-IMPER-1-02B     | 402 | GZ-CRPB40-A1    | 406 | GZ-UDINE-1-10M    | 362      |
| A-TG-405-20M    | 493 | GA-IMPER-1-11      | 402 | GZ-CRPC30-01    | 406 | GZ-UDINE-1-12N    | 362      |
| A-TG-405-90     | 493 | GA-IMPER-1-20M     | 402 | GZ-LORENA-1-18  | 353 | GZ-UDINE-1-20M    | 362      |
| A-TG-600-05     | 493 | GA-STRUCTURE-1-20M | 356 | GZ-LORENA-1-20M | 353 | GZ-VENICE-1-20M   | 348      |
| A-TG-600-10     | 493 | GP-0728-J4-A-04    | 386 | GZ-LORENA-1-21  | 353 | GZ-VENICE-1-90    | 348      |
| A-TG-600-20M    | 493 | GP-0728-J4-A-07    | 386 | GZ-MILAN-32-20M | 329 | GZ-WP1136-04      | 397      |
| A-TG-600-90     | 493 | GP-0728-J4-B       | 386 | GZ-NORD-1-03    | 347 | GZ-WP1148-04      | 398      |
| A-TG-BUD-200-00 | 520 | GP-0728-J4-C-04    | 386 | GZ-NORD-1-18    | 347 | GZ-WP1152-04      | 398      |

|                    |     |                        |     |                  |     |                |     |
|--------------------|-----|------------------------|-----|------------------|-----|----------------|-----|
| GZ-WP1155-01       | 363 | KM-00-40-D20           | 476 | KM-RD-75-CF      | 480 | KO-SR150-50-OC | 269 |
| GZ-ZH-011-05A      | 363 | KM-00-50-D20           | 476 | KM-RD-75-CF-20   | 480 | KO-SR150-60-10 | 269 |
|                    |     | KM-0H-40-D20           | 476 | KM-RD-75-SF      | 480 | KO-SR150-60-OC | 269 |
|                    |     | KM-0H-50-D20           | 476 | KM-RD-75-SF-20   | 480 | KO-SR200-30-10 | 269 |
| HB-USB-4X-60       | 299 | KM-015030-10           | 476 | KM-SPAIN-40MM-18 | 481 | KO-SR200-30-OC | 269 |
|                    |     | KM-015030-20           | 476 | KM-SPAIN-50MM-18 | 481 | KO-SR200-40-10 | 269 |
|                    |     | KM-015038-10           | 476 | KO-150B0-01      | 290 | KO-SR200-40-OC | 269 |
| ID-GZ-CRPJ30-01    | 407 | KM-015038-GM           | 477 | KO-150B0-01B     | 290 | KO-SR200-50-10 | 269 |
| ID-GZ-CRPJ40-01    | 407 | KM-A035MM-00           | 477 | KO-150B0-60      | 290 | KO-SR200-50-OC | 269 |
| ID-RS-E-15696-20M  | 364 | KM-A035MM-30           | 477 | KO-150B0-E-01    | 293 | KO-SR200-60-10 | 269 |
| ID-RS-E-188128-20M | 364 | KM-A050MM-00           | 478 | KO-200B0-01      | 290 | KO-SR200-60-OC | 269 |
| ID-RS-E-220160-06  | 364 | KM-A050MM-30           | 478 | KO-200B0-01B     | 290 | KO-UMC450-01   | 289 |
| ID-RS-E-220160-20M | 364 | KM-AH35MM-00           | 477 | KO-200B0-60      | 290 | KO-UMC450-01B  | 289 |
| ID-RS-E-272192-06  | 364 | KM-AH35MM-30           | 477 | KO-200B0-E-01    | 293 | KO-UMC450-60   | 289 |
| ID-RS-E-272192-20M | 364 | KM-AH50MM-00           | 478 | KO-300B0-01      | 292 | KO-WMC450-01   | 288 |
| ID-RS-E-304224-06  | 364 | KM-AH50MM-30           | 478 | KO-300B0-01B     | 292 | KO-WMC450-01B  | 288 |
| ID-RS-E-304224-20M | 364 | KM-B050MM-00           | 478 | KO-300B0-60      | 292 | KO-WMC450-60   | 288 |
| ID-RS-E-336256-06  | 364 | KM-B050MM-30           | 478 | KO-400B0-01      | 292 | KO-WMC500-01   | 288 |
| ID-RS-E-336256-20M | 364 | KM-B075MM-00           | 479 | KO-400B0-01B     | 292 | KO-WMC500-01B  | 288 |
| ID-RS-E-368288-06  | 364 | KM-B075MM-30           | 479 | KO-400B0-60      | 292 | KO-WMC500-60   | 288 |
| ID-RS-E-368288-20M | 364 | KM-BH50MM-00           | 478 | KO-500B0-01      | 292 | KT-WP1147-04   | 399 |
| ID-RS-E-400320-06  | 364 | KM-BH50MM-30           | 478 | KO-500B0-01B     | 292 | KW-FS0125-01   | 220 |
| ID-RS-E-400320-20M | 364 | KM-BH75MM-00           | 479 | KO-500B0-60      | 292 | KW-FS0140-01   | 220 |
|                    |     | KM-BH75MM-30           | 479 | KO-SR100-30-10   | 269 | KW-FS0335-01   | 221 |
|                    |     | KM-GREYROLL-50mm-BH481 |     | KO-SR100-30-OC   | 269 | KW-FS0350-01   | 221 |
| KK-D50-80-06       | 312 | KM-GREYROLL-50mm-ZH481 |     | KO-SR100-40-10   | 269 | KW-FS0375-01   | 221 |
| KK-D50100-06       | 312 | KM-GREYROLL-75mm-BH481 |     | KO-SR100-40-OC   | 269 | KW-FS0425-03   | 221 |
| KK-W60245-M0       | 311 | KM-GREYROLL-75mm-ZH481 |     | KO-SR100-50-10t  | 269 | KW-FS0450-03   | 221 |
| KK-W60245-M1       | 311 | KM-RD-35-CF            | 479 | KO-SR100-50-OC   | 269 | KW-FS0650-01   | 222 |
| KK-W60245-M2       | 311 | KM-RD-35-CF-20         | 479 | KO-SR100-60-10   | 269 |                |     |
| KK-W60245-M6       | 311 | KM-RD-35-SF            | 479 | KO-SR100-60-OC   | 269 | <b>L</b>       |     |
| KK-W60800-M0       | 313 | KM-RD-35-SF-20         | 479 | KO-SR150-30-10   | 269 | LB-80X100-05   | 300 |
| KK-W60800-M1       | 313 | KM-RD-50-CF            | 480 | KO-SR150-30-OC   | 269 | LB-80X100-20   | 300 |
| KK-W80800-D0       | 313 | KM-RD-50-CF-20         | 480 | KO-SR150-40-10   | 269 | LB-80X160-05   | 301 |
| KK-W80800-D1       | 313 | KM-RD-50-SF            | 480 | KO-SR150-40-OC   | 269 | LB-80X160-20   | 301 |
| KK-W80800-D2       | 313 | KM-RD-50-SF-20         | 480 | KO-SR150-50-10   | 269 | LB-80X280-05   | 301 |

|                           |     |                        |     |                    |     |                    |     |
|---------------------------|-----|------------------------|-----|--------------------|-----|--------------------|-----|
| LB-80X280-20              | 301 | LD-2835-600-65-NE4     | 526 | LD-5630-300-65-NE4 | 527 | LD-NF12V6x12-65-ZB | 531 |
| LB-80X500-05              | 302 | LD-2835-600-65-ZB      | 526 | LD-5630-300-65-ZB  | 527 | LD-OBP27CB-53      | 568 |
| LB-80X500-20              | 302 | LD-3014-1200-20-CB     | 527 | LD-AL24CB-53       | 566 | LD-OBP27ZB-53      | 568 |
| LB-K80X80-05              | 300 | LD-3014-1200-20-NE4    | 527 | LD-AL24NE-53       | 566 | LD-OPD5W0-CB       | 570 |
| LB-K80X80-20              | 300 | LD-3014-1200-20-ZB     | 527 | LD-AL24ZB-53       | 566 | LD-OPD9W0-CB       | 570 |
| LD-3SKL-CBN               | 573 | LD-3528-300-20-CB      | 526 | LD-BOS1CBWG-53     | 572 | LD-PIRUSB-53       | 571 |
| LD-3SKL-NBN               | 573 | LD-3528-300-20-CB-50   | 528 | LD-CHIC16NE-10DIM  | 571 | LD-RA60CB-40N      | 570 |
| LD-3SKL-ZBN               | 573 | LD-3528-300-20-NE4P    | 526 | LD-CHIC16NE-20DIM  | 571 | LD-RA60ZB-40N      | 570 |
| LD-2835-24V-300-20-CB     | 528 | LD-3528-300-20-NE4P-50 | 528 | LD-COB12V-20-CB    | 530 | LD-RGB-150-20      | 527 |
| LD-2835-24V-300-20-NE4    | 528 | LD-3528-300-20-NI      | 526 | LD-COB12V-20-NE    | 530 | LD-RGB-150-65      | 527 |
| LD-2835-24V-300-20-ZB     | 528 | LD-3528-300-20-ZB      | 526 | LD-COB12V-20-ZB    | 530 | LD-RGBW-300-20     | 527 |
| LD-2835-24V-600-20-CB     | 528 | LD-3528-300-20-ZB-50   | 528 | LD-CS36CB-53       | 564 | LD-TR24CB-53       | 567 |
| LD-2835-24V-600-20-NE4    | 528 | LD-3528-300-65-CB      | 526 | LD-CS36NE-53       | 564 | LD-TR24NE-53       | 567 |
| LD-2835-24V-600-20-ZB     | 528 | LD-3528-300-65-NE4     | 526 | LD-CS36ZB-53       | 564 | LD-TR24ZB-53       | 567 |
| LD-2835-60-60-20-CCT      | 527 | LD-3528-300-65-ZB      | 526 | LD-DIMLED-10       | 593 | LD-UNF-12V6X12-6X  | 531 |
| LD-2835-300-20-CB         | 526 | LD-3528-600-20-CB      | 526 | LD-IRUSB-53        | 571 | LD-VA24CB-53       | 563 |
| LD-2835-300-20-CB-50      | 528 | LD-3528-600-20-CB-50   | 528 | LD-KABE2M-00       | 595 | LD-VA24NE-53       | 563 |
| LD-2835-300-20-CBN        | 526 | LD-3528-600-20-NE4     | 526 | LD-KLPCB-00N       | 572 | LD-VA24ZB-53       | 563 |
| LD-2835-300-20-NE4N       | 526 | LD-3528-600-20-NE4-50  | 528 | LD-KLPNB-00N       | 572 | LD-VE15CB-53N      | 566 |
| LD-2835-300-20-NE4P       | 526 | LD-3528-600-20-ZB      | 526 | LD-KLPZB-00N       | 572 | LD-VE15CBZB-53N    | 567 |
| LD-2835-300-20-NE4P-50    | 528 | LD-3528-600-20-ZB-50   | 528 | LD-KONMINI-RGB     | 580 | LD-VE15NE-53N      | 566 |
| LD-2835-300-20-ZB         | 526 | LD-3528-600-65-CB      | 526 | LD-KONML-AD        | 584 | LD-VE15ZB-53N      | 566 |
| LD-2835-300-20-ZB-50      | 528 | LD-3528-600-65-NE4     | 526 | LD-KONML-MONO      | 581 | LD-WL2457-53       | 569 |
| LD-2835-300-20-ZBN        | 526 | LD-3528-600-65-ZB      | 526 | LD-KONML-MONO-PAN  | 582 | LD-WZA20W-NW       | 577 |
| LD-2835-300-65-CB         | 526 | LD-5050-300-20-CB      | 527 | LD-KONML-MONO-PIL  | 581 | LD-WZA36W-NW       | 577 |
| LD-2835-300-65-CBN        | 526 | LD-5050-300-20-NE4     | 527 | LD-KONML-RGBW      | 582 | LD-WZA60W-NW       | 577 |
| LD-2835-300-65-NE4N       | 526 | LD-5050-300-20-NE4-50  | 528 | LD-KONML-RGBW-PIL  | 583 | LD-WZA80W-NW       | 577 |
| LD-2835-300-65-ZB         | 526 | LD-5050-300-20-ZB      | 527 | LD-KONML-WIFI      | 584 | LD-WZA150W-NW      | 577 |
| LD-2835-300-65-ZBN        | 526 | LD-5050-300-65-CB      | 527 | LD-KONML-WRGB-PAN  | 583 | LD-Z3CSCB-53       | 568 |
| LD-2835-600-5MM-20-CB     | 527 | LD-5050-300-65-NE4     | 527 | LD-KWP27CB-53      | 569 | LD-ZAC6WDE-RGB     | 579 |
| LD-2835-600-5MM-20-NE4527 |     | LD-5050-300-65-ZB      | 527 | LD-KWP27ZB-53      | 569 | LD-ZAS09WEC-30     | 573 |
| LD-2835-600-5MM-20-ZB     | 527 | LD-5630-300-20-CB      | 527 | LD-LU16CB-53       | 564 | LD-ZAS15WEC-30     | 573 |
| LD-2835-600-20-CB         | 526 | LD-5630-300-20-NE4     | 527 | LD-LU16NE-53       | 564 | LD-ZAS20WEC-30     | 573 |
| LD-2835-600-20-NE4        | 526 | LD-5630-300-20-NE4-50  | 528 | LD-LU16ZB-53       | 564 | LD-ZAS24PRO80W-30  | 574 |
| LD-2835-600-20-ZB         | 526 | LD-5630-300-20-ZB      | 527 | LD-NF12V6x12-65-CB | 531 | LD-ZAS30WEC-30     | 573 |
| LD-2835-600-65-CB         | 526 | LD-5630-300-65-CB      | 527 | LD-NF12V6x12-65-NE | 531 | LD-ZAS60WEC-30     | 573 |

|                     |     |                 |     |                       |     |                |     |
|---------------------|-----|-----------------|-----|-----------------------|-----|----------------|-----|
| LD-ZAS75W-30        | 574 | LD-ZWND6W-10    | 579 | MC-J62-01             | 214 | MP-118400-10   | 157 |
| LD-ZAS150-NW        | 576 | LD-ZWND12-10    | 579 | MC-J63-05             | 210 | MP-118450-10   | 157 |
| LD-ZAS350-NW        | 577 | LD-ZZAS07PROKD6 | 575 | MC-J65-08-01          | 211 | MP-118500-10   | 157 |
| LD-ZASNF-12V6X12-65 | 531 | LD-ZZAS12PROKD6 | 575 | MC-J65-08-05          | 211 | MP-150270-10   | 157 |
| LD-ZASPRO07W-30     | 576 | LD-ZZAS16PROKD6 | 575 | MC-J65-10-01          | 211 | MP-150300-10   | 157 |
| LD-ZASPRO12W-30     | 576 | LD-ZZAS24PROKD6 | 575 | MC-J65-10-05          | 211 | MP-150350-10   | 157 |
| LD-ZASPRO16W-30     | 576 | LD-ZZAS33PROKD6 | 575 | MC-J65-12-01          | 211 | MP-150400-10   | 157 |
| LD-ZASPRO24W-30     | 576 | LMB-BOCZ38L-05  | 233 | MC-J65-12-05          | 211 | MP-150450-10   | 157 |
| LD-ZASPRO33W-30     | 576 | LMB-BOCZ38L-20M | 233 | MC-J123-01            | 211 | MP-150500-10   | 157 |
| LD-ZASPRO54W-30     | 576 | LMB-BOCZ38P-05  | 233 | MC-J123-05            | 211 | MP-150550-10   | 157 |
| LD-ZASPRO65W-30     | 576 | LMB-BOCZ38P-20M | 233 | MC-K135-06-01         | 212 | MR-R0050-001   | 238 |
| LD-ZASPRO80W-30     | 576 | LMB-KAT38-05    | 234 | MG-MENSA-010          | 232 | MR-RDRO-0000   | 236 |
| LD-ZASPU15W-30N     | 578 | LMB-KAT38-20M   | 234 | MG-MENSA-030          | 232 | MR-RS025-001   | 238 |
| LD-ZL5RGB150-00     | 529 | LMB-SZCZ38-05   | 235 | MM-FI20X6X7-PL10-A-1T | 228 | MR-SPG-UNI-GAL | 121 |
| LD-ZSKL15-00N       | 578 | LMB-SZCZ38-20M  | 235 | MM-FI20X6X7-PL20-A-1T | 228 | MR-SPG-UNI-OC  | 121 |
| LD-ZTK8MM-02N       | 598 | LO-00-00-001    | 233 | MM-FI20X6X7-PL30-A-1T | 228 | MR-TDL011-01   | 215 |
| LD-ZTK8MM-02N600    | 598 | LO-00-00-003    | 233 | MM-FI20X6X7-PL80-A-1T | 228 | MR-TH002-L01   | 245 |
| LD-ZTK10MM-02N      | 598 | LO-M2M-00-125   | 227 | MM-FI20X6X7-ZN-A-1T   | 228 | MR-TH002-P01   | 245 |
| LD-ZTKS8MM-02N      | 600 | LZ-AKZ312-10N   | 596 | MP-054350-10          | 157 | MR-TH004-001   | 243 |
| LD-ZTKT8MM-02N      | 598 | LZ-AKZ612-10N   | 597 | MP-054400-10          | 157 | MR-TH005-001   | 242 |
| LD-ZTKT8MM-02N600   | 598 | LZ-KA2MM-10     | 595 | MP-054450-10          | 157 | MR-TH009-001   | 244 |
| LD-ZTKT10MM-02N     | 598 | LZ-KAPR2M-10    | 596 | MP-054450-80          | 157 | MR-TH016-001   | 242 |
| LD-ZTKTRGB-04N      | 598 |                 |     | MP-054500-10          | 157 | MR-TH018-KPL   | 243 |
| LD-ZTL8MM-02N       | 597 | <b>M</b>        |     | MP-054500-80          | 157 | MR-TH018-L01   | 246 |
| LD-ZTL8MM-02N600    | 597 | MA-MATA-1-10    | 202 | MP-086270-10          | 157 | MR-TH018-P01   | 246 |
| LD-ZTL8MMAMP-02N    | 599 | MA-MATA-1-20    | 202 | MP-086300-10          | 157 | MR-TH019-001   | 247 |
| LD-ZTL8MMAMP-02N600 | 599 | MA-MATA-1-60    | 202 | MP-086350-10          | 157 | MR-TH019-003   | 247 |
| LD-ZTL10MM-02N      | 597 | MC-J01A-12-01   | 212 | MP-086350-80          | 157 | MR-TH035-KPL   | 244 |
| LD-ZTL82M-2N        | 599 | MC-J01A-12-06   | 212 | MP-086400-10          | 157 | MR-THA12-001   | 241 |
| LD-ZTL82M-2N600     | 599 | MC-J01A-16-01   | 212 | MP-086400-80          | 157 | MR-THB12-001   | 241 |
| LD-ZTL102M-2N       | 599 | MC-J01A-16-06   | 212 | MP-086450-10          | 157 | MR-THQZ1-001   | 246 |
| LD-ZTLRGB2M-4N      | 599 | MC-J04A2-14-01  | 213 | MP-086450-80          | 157 | MR-WP-010-01   | 240 |
| LD-ZTLRGB-04N       | 597 | MC-J04A2-14-05  | 213 | MP-086500-10          | 157 | MR-WP-011-01   | 240 |
| LD-ZTLS8MM-02N      | 600 | MC-J04A2-18-01  | 213 | MP-086500-80          | 157 | MR-WP-15-KPL   | 245 |
| LD-ZTLS8MMAMP-02N   | 600 | MC-J04A2-22-01  | 213 | MP-086550-10          | 157 | MR-WP-028-01   | 236 |
| LD-ZTLS82M-2N       | 600 | MC-J60A27-01    | 213 | MP-118350-10          | 157 | MR-WP2802-01   | 248 |

|                |     |                      |     |                      |     |                        |     |
|----------------|-----|----------------------|-----|----------------------|-----|------------------------|-----|
| MR-WP2804-01   | 249 | NM-A60870-10N*       | 459 | NM-ARTO-12-3R711-20M | 466 | NM-F50710-01           | 463 |
| MR-WP2806-01   | 249 | NM-A60870-20*        | 459 | NM-BAHIA40-150-01    | 442 | NM-F50710-06           | 463 |
| MR-WP2807-20   | 250 | NM-A60870-80N*       | 459 | NM-BD-001-M1B        | 446 | NM-F50710-10           | 463 |
| MR-WP2815-01   | 248 | NM-A61100-01         | 459 | NM-BD-003-01         | 438 | NM-F50710-20           | 463 |
| MR-WPS01-001   | 251 | NM-A61100-02         | 459 | NM-BD-003-02         | 438 | NM-F50870-01           | 463 |
| MR-WPS03-001   | 251 | NM-A61100-05         | 459 | NM-BD-100-01         | 439 | NM-F50870-06           | 463 |
| MR-WPZ002-01   | 239 | NM-A61100-06         | 459 | NM-BD-100-02         | 439 | NM-F50870-10           | 463 |
| MR-WPZ003-01   | 239 | NM-A61100-10N*       | 459 | NM-BD-100-05         | 439 | NM-F50870-20           | 463 |
| MR-WPZ023-01   | 250 | NM-A61100-20         | 459 | NM-BD-100-06         | 439 | NM-G60710-01N          | 461 |
| MR-ZSL011-01   | 215 | NM-A80710-01         | 460 | NM-BD-150-01         | 438 | NM-G60710-02N          | 461 |
|                |     | NM-A80710-02         | 460 | NM-BD-150-02         | 438 | NM-G60710-05N          | 461 |
|                |     | NM-A80710-03         | 460 | NM-BD-712-M1         | 446 | NM-G60710-06N          | 461 |
| NM-46R710-05   | 469 | NM-A80710-05         | 460 | NM-BD727-100         | 444 | NM-G60710-10N          | 461 |
| NM-46R820-05   | 469 | NM-A80710-06         | 460 | NM-BD-739-05         | 444 | NM-G60710-20N          | 461 |
| NM-60R710-05   | 469 | NM-A80710-10         | 460 | NM-BD-762-01         | 440 | NM-G60710-80N          | 461 |
| NM-60R710-06   | 469 | NM-A80710-20         | 460 | NM-BD-762-05         | 440 | NM-G60820-01N          | 461 |
| NM-60R710-20   | 469 | NM-A80710-80         | 460 | NM-BD-780-M1         | 439 | NM-G60820-05N          | 461 |
| NM-60R820-05   | 469 | NM-A80870-01         | 460 | NM-BD-780-M2         | 439 | NM-G60820-06N          | 461 |
| NM-A60710-01   | 459 | NM-A80870-02         | 460 | NM-BD-780-M5         | 439 | NM-G60820-10N*         | 461 |
| NM-A60710-02   | 459 | NM-A80870-03         | 460 | NM-BD867-100         | 440 | NM-G60820-20N          | 461 |
| NM-A60710-05   | 459 | NM-A80870-05         | 460 | NM-BD868-100         | 441 | NM-G61100-01N          | 461 |
| NM-A60710-06   | 459 | NM-A80870-06         | 460 | NM-BD868-150         | 441 | NM-G61100-20N          | 461 |
| NM-A60710-10N  | 459 | NM-A80870-10         | 460 | NM-BD869-150         | 441 | NM-INDUSTRIA-H20-710X- |     |
| NM-A60710-20   | 459 | NM-A80870-20         | 460 | NM-DAK27-060         | 445 | 820-20M                | 470 |
| NM-A60710-80N  | 459 | NM-A80870-80         | 460 | NM-DAK27-080         | 445 | NM-INDUSTRIA-H40-710X- |     |
| NM-A60820-01   | 459 | NM-ARTO-10-2R304-20M | 468 | NM-DAK27-100         | 445 | 820-20M                | 470 |
| NM-A60820-02   | 459 | NM-ARTO-10-2R406-20M | 468 | NM-DAK27-120         | 445 | NM-INDUSTRIA-P20-710X- |     |
| NM-A60820-05   | 459 | NM-ARTO-10-2R711-20M | 468 | NM-DAK27-150         | 445 | 820-20M                | 472 |
| NM-A60820-06   | 459 | NM-ARTO-10-3R304-20M | 466 | NM-DAP77-60          | 442 | NM-INDUSTRIA-P40-710X- |     |
| NM-A60820-10N* | 459 | NM-ARTO-10-3R406-20M | 466 | NM-DAP77-100         | 442 | 820-20M                | 472 |
| NM-A60820-20   | 459 | NM-ARTO-10-3R711-20M | 466 | NM-DAP77-150         | 442 | NM-INDUSTRIA-P80-710X- |     |
| NM-A60820-80N  | 459 | NM-ARTO-12-2R304-20M | 468 | NM-DPA20-100         | 454 | 820-20M                | 472 |
| NM-A60870-01*  | 459 | NM-ARTO-12-2R406-20M | 468 | NM-DPA20-100W        | 454 | NM-INDUSTRIA-T20-710X- |     |
| NM-A60870-02*  | 459 | NM-ARTO-12-2R711-20M | 468 | NM-DPA20-150         | 454 | 820-20M                | 473 |
| NM-A60870-05*  | 459 | NM-ARTO-12-3R304-20M | 466 | NM-DPA20-150W        | 454 | NM-INDUSTRIA-T40-710X- |     |
| NM-A60870-06*  | 459 | NM-ARTO-12-3R406-20M | 466 | NM-DPD20-100         | 453 | 820-20M                | 473 |

|                               |     |                   |     |                             |           |                        |     |
|-------------------------------|-----|-------------------|-----|-----------------------------|-----------|------------------------|-----|
| NM-INDUSTRIA-X20-710X-820-20M | 474 | NM-SQA150-01      | 443 | OC-A0350K-06                | 296       | PA-GLAXGKWK3M-00C      | 538 |
|                               |     | NM-STGY135-100-01 | 447 | OC-A0450-06                 | 296       | PA-GLAXGKZK3M-00C      | 540 |
| NM-INDUSTRIA-X40-710X-820-20M | 474 | NM-STGY135-130-01 | 447 | OC-A0460D-06                | 297       | PA-GLAXKT3M-AL         | 560 |
|                               |     | NM-STGY135-150-01 | 447 | OC-A0660-06                 | 294       | PA-GLAXKT-AL           | 560 |
| NM-INDUSTRIA-X80-710X-820-20M | 474 | NM-STOMP-100-01   | 448 | OC-A0680-06                 | 294       | PA-GLAXMIC3M-AL        | 545 |
|                               |     | NM-STOMP-120-10   | 448 | OC-E0707D-CZ                | 297       | PA-GLAXMIC-AL          | 545 |
| NM-KL-DPA-20                  | 455 | NM-STOMP-120-20   | 448 | OM-OBK150-20B               | 314       | PA-GLAXMICNK3M-AL      | 541 |
| NM-KL-DPL-20                  | 454 | NM-STOMP-130-01   | 448 | OM-OBK175-20                | 314       | PA-GLAXMICNK-AL        | 541 |
| NM-MDN926-01                  | 449 | NM-STOMP-130-06   | 448 | OM-OBO300-05                | 314       | PA-GLAXMNBWD3M19-AL553 |     |
| NM-MDN927-01                  | 449 | NM-STOMP-130-20   | 448 | OM-OBO400-05                | 314       | PA-GLAXMNBWD3M-AL      | 553 |
| NM-MDN941-01                  | 450 | NM-STOMP-150-01   | 448 |                             |           | PA-GLAXMNBJW3M19-AL    | 552 |
| NM-MDN-D4-01                  | 448 | NM-STOMP-160-01   | 448 | <b>P</b>                    |           | PA-GLAXMNBJW3M-AL      | 552 |
| NM-MLA-50-75                  | 455 | NM-STOMP-160-06   | 448 | PA-0241-35-50               | 376       | PA-GLAXMNK3M-AL        | 542 |
| NM-MLA-65-85                  | 456 | NM-STOMP-160-20   | 448 | PA-0242-35-50               | 376       | PA-GLAXMNK3M-AL-10     | 542 |
| NM-MLA-85-125                 | 456 | NM-STOPKA-M6      | 452 | PA-0242-35-50-06            | 376       | PA-GLAXMNK3M-AL-20M    | 542 |
| NM-MLA-95-145                 | 457 | NM-STOPKSZESTK-M6 | 452 | PA-0242-35-50-20M           | 376       | PA-GLAXMNK-AL          | 542 |
| NM-MLA-125-195                | 457 | NM-WPJ22-D20      | 450 | PA-0243-35-50               | 377       | PA-GLAXMNK-AL-10       | 542 |
| NM-MLA-KL                     | 458 | NM-X-LINE40710-01 | 464 | PA-0243-35-50-06            | 377       | PA-GLAXMNK-AL-20M      | 542 |
| NM-MUFAWB-00                  | 453 | NM-X-LINE40710-10 | 464 | PA-0243-35-50-20M           | 377       | PA-GLAXMNK-AL-90       | 542 |
| NM-MUFAWK-00                  | 453 | NM-X-LINE40710-20 | 464 | PA-CPGLAXAH-00              | 532, 534, | PA-GLAXMNKW-AL         | 544 |
| NM-NACK27651-06               | 445 |                   |     | 536, 538, 540               |           | PA-GLAXMNKW-AL-10      | 544 |
| NM-S60710-01A                 | 462 | <b>O</b>          |     | PA-CPGLAXAV-00              | 532, 534, | PA-GLAXMNKW-AL-20M     | 544 |
| NM-S60710-02A                 | 462 | OC-2PV340-02-18   | 295 | 536, 538, 540               |           | PA-GLAXMNKW-AL-90      | 544 |
| NM-S60710-05A                 | 462 | OC-2PV345-02-18   | 295 | PA-CPGLAXL-00532, 534, 536, |           | PA-GLAXMPK-AL          | 554 |
| NM-S60710-06A                 | 462 | OC-2PV350-02-18   | 295 | 538, 540                    |           | PA-GLAXMW-AL           | 547 |
| NM-S60710-10A                 | 462 | OC-2PV360-02-18   | 295 | PA-GLAX3M-AL                | 546       | PA-GLAXMW-AL-10        | 547 |
| NM-S60710-20A                 | 462 | OC-2PV360-02-18A  | 295 | PA-GLAX3M-AL-10             | 546       | PA-GLAXMW-AL-20M       | 547 |
| NM-S60820-01A                 | 462 | OC-2PV370-02-18   | 295 | PA-GLAX3M-AL-20M            | 546       | PA-GLAXMW-AL-90        | 547 |
| NM-S60820-02A                 | 462 | OC-2PV380-02-18   | 295 | PA-GLAX-AL                  | 546       | PA-GLAXNBD3M16-AL      | 558 |
| NM-S60820-05A                 | 462 | OC-2PV380-02-18A  | 295 | PA-GLAX-AL-10               | 546       | PA-GLAXNBD3M19-AL      | 558 |
| NM-S60820-06A                 | 462 | OC-2PV390-02-18   | 295 | PA-GLAX-AL-20M              | 546       | PA-GLAXNBD3M-AL        | 558 |
| NM-S60820-10A                 | 462 | OC-A0150-06       | 294 | PA-GLAX-AL-90               | 546       | PA-GLAXNBDW3M16-AL     | 559 |
| NM-S60820-20A                 | 462 | OC-A0160-06       | 294 | PA-GLAXDR-AL                | 548       | PA-GLAXNBDW3M19-AL     | 559 |
| NM-SQ40ADJ-060                | 443 | OC-A0170-06       | 294 | PA-GLAXGKL3M-00C            | 532       | PA-GLAXNBDW3M-AL       | 559 |
| NM-SQ40ADJ-100                | 443 | OC-A0180-06       | 294 | PA-GLAXGKS3M-00C            | 534       | PA-GLAXNB3M16-AL       | 556 |
| NM-SQA100-01                  | 443 | OC-A0190-06       | 294 | PA-GLAXGKW3M-00C            | 536       | PA-GLAXNB3M19-AL       | 556 |



|                       |     |                       |                          |                   |                          |                    |     |
|-----------------------|-----|-----------------------|--------------------------|-------------------|--------------------------|--------------------|-----|
| PA-GLAXNBJ3M-AL       | 556 | PA-LACZVELLO-LIN-10M  | 385                      | PA-OSTRGLAX3M-00  | 543, 546,                | PA-VELLO-TD3M-21   | 383 |
| PA-GLAXNBJW3M16-AL    | 557 | PA-LACZVELLO-LIN-20M  | 385                      |                   | 550, 551, 556, 557, 558, | PA-VELLO-TJ3M-05   | 382 |
| PA-GLAXNBJW3M19-AL    | 557 | PA-LACZVELLO-LIN-21   | 385                      |                   | 559, 560                 | PA-VELLO-TJ3M-06   | 382 |
| PA-GLAXNBJW3M-AL      | 557 | PA-LACZVELLO-LOUT-05  | 385                      | PA-OSTRGLAXM-00   | 542, 544,                | PA-VELLO-TJ3M-10   | 382 |
| PA-GLAXNK3M-AL        | 543 | PA-LACZVELLO-LOUT-06  | 385                      |                   | 547, 554                 | PA-VELLO-TJ3M-20M  | 382 |
| PA-GLAXNK-AL          | 543 | PA-LACZVELLO-LOUT-10M | 385                      | PA-OSTRGLAXM3M-00 | 542,                     | PA-VELLO-TJ3M-21   | 382 |
| PA-GLAXNKKT3M-AL      | 551 | PA-LACZVELLO-LOUT-20M | 385                      |                   | 552, 553                 | PA-ZASGLAX-00      | 546 |
| PA-GLAXNKKT3M-AL-10   | 551 | PA-LACZVELLO-LOUT-21  | 385                      | PA-ROZGLAX-53     | 548                      | PA-ZASGLAX-10      | 546 |
| PA-GLAXNKKT3M-AL-20M  | 551 | PA-OSMLGLAX-00        | 543, 546,                | PA-ROZGLAXP-53    | 548                      | PA-ZASGLAX-20M     | 546 |
| PA-GLAXNKKT-AL        | 551 |                       | 548, 549, 550, 551, 555, | PA-SPRGLAXM-00    | 542, 544,                | PA-ZASGLAX-90      | 546 |
| PA-GLAXNKKT-AL-10     | 551 |                       | 560, 561                 |                   | 549                      | PA-ZASGLAXDR-00    | 548 |
| PA-GLAXNKKT-AL-20M    | 551 | PA-OSMLGLAX3M-00      | 543, 546,                | PA-SPRGLAXMIC-00  | 541, 551                 | PA-ZASGLAXKT-00    | 560 |
| PA-GLAXNKKT-AL-90     | 551 |                       | 550, 551, 556, 557, 558, | PA-USZGLAX-00N    | 550                      | PA-ZASGLAXMIC-00   | 545 |
| PA-GLAXRAD-AL         | 549 |                       | 559, 560                 | PA-USZGLAX-10N    | 550                      | PA-ZASGLAXMICNK-00 | 541 |
| PA-GLAXREG1-AL        | 555 | PA-OSMLGLAXM-00       | 542, 544,                | PA-VELLO-C3M-05   | 380                      | PA-ZASGLAXMNK-00   | 542 |
| PA-GLAXREG2-AL        | 555 |                       | 547, 554                 | PA-VELLO-C3M-06   | 380                      | PA-ZASGLAXMNK-20M  | 542 |
| PA-GLAXWN3M-AL        | 550 | PA-OSMLGLAXM3M-00     | 532,                     | PA-VELLO-C3M-10   | 380                      | PA-ZASGLAXMNK-90   | 542 |
| PA-GLAXWN3M-AL-06     | 550 |                       | 534, 536, 538, 540, 542, | PA-VELLO-C3M-20M  | 380                      | PA-ZASGLAXMNKK-00  | 542 |
| PA-GLAXWN3M-AL-10     | 550 |                       | 552, 553                 | PA-VELLO-C4M-05   | 380                      | PA-ZASGLAXMNKO-00  | 542 |
| PA-GLAXWN3M-AL-20M    | 550 | PA-OSMLGLAXMIC-00N    | 541,                     | PA-VELLO-C4M-06   | 380                      | PA-ZASGLAXMNKW-00  | 544 |
| PA-GLAXWN16-AL        | 550 |                       | 545                      | PA-VELLO-C4M-10   | 380                      | PA-ZASGLAXMNKW-10  | 544 |
| PA-GLAXWN19-AL        | 550 | PA-OSMLGLAXMIC3M-00N  |                          | PA-VELLO-C4M-20M  | 380                      | PA-ZASGLAXMNKW-20M | 544 |
| PA-GLAXWN-AL          | 550 |                       | 541, 545                 | PA-VELLO-C4M-21   | 380                      | PA-ZASGLAXMNKW-90  | 544 |
| PA-GLAXWPKT-AL        | 561 | PA-OSMLGLAXMK-00      | 542, 547                 | PA-VELLO-L3M-05   | 378                      | PA-ZASGLAXMW-00    | 547 |
| PA-LACZVELLO-CIN-05   | 384 | PA-OSMLGLAXMK3M-00    | 532,                     | PA-VELLO-L3M-06   | 378                      | PA-ZASGLAXMW-10    | 547 |
| PA-LACZVELLO-CIN-06   | 384 |                       | 534, 536, 538, 540       | PA-VELLO-L3M-10   | 378                      | PA-ZASGLAXMW-20M   | 547 |
| PA-LACZVELLO-CIN-10M  | 384 | PA-OSMLGLAXM0-00      | 542                      | PA-VELLO-L3M-20M  | 378                      | PA-ZASGLAXMW-90    | 547 |
| PA-LACZVELLO-CIN-20M  | 384 | PA-OSMLGLAXM03M-00    | 532,                     | PA-VELLO-L4M-05   | 378                      | PA-ZASGLAXMWK-00   | 547 |
| PA-LACZVELLO-CIN-21   | 384 |                       | 534, 536, 538, 540       | PA-VELLO-L4M-06   | 378                      | PA-ZASGLAXNK-00    | 543 |
| PA-LACZVELLO-COUT-05  | 384 | PA-OSMLGLAXSO-00      | 549                      | PA-VELLO-L4M-10   | 378                      | PA-ZASGLAXNKKT-00  | 551 |
| PA-LACZVELLO-COUT-06  | 384 | PA-OSMLGLAXT-00       | 551                      | PA-VELLO-L4M-20   | 378                      | PA-ZASGLAXNKKT-10  | 551 |
| PA-LACZVELLO-COUT-10M | 384 | PA-OSMLGLAXT3M-00     | 532,                     | PA-VELLO-L4M-21   | 378                      | PA-ZASGLAXNKKT-20M | 551 |
| PA-LACZVELLO-COUT-20M | 384 |                       | 534, 536, 538, 540       | PA-VELLO-TD3M-05  | 383                      | PA-ZASGLAXNKKT-90  | 551 |
| PA-LACZVELLO-COUT-21  | 384 | PA-OSTRGLAX-00        | 543,                     | PA-VELLO-TD3M-06  | 383                      | PA-ZASGLAXNKKT-00  | 551 |
| PA-LACZVELLO-LIN-05   | 385 |                       | 546, 548, 549, 550, 551, | PA-VELLO-TD3M-10  | 383                      | PA-ZASGLAXRAD-00   | 549 |
| PA-LACZVELLO-LIN-06   | 385 |                       | 555, 560, 561            | PA-VELLO-TD3M-20M | 383                      | PA-ZASVELLO-CN-05  | 380 |

|                     |          |                     |     |                            |          |                     |     |
|---------------------|----------|---------------------|-----|----------------------------|----------|---------------------|-----|
| PA-ZASVELLO-CN-06   | 380      | PB-0FPO18-400       | 128 | PB-45-002X15-60A           | 280      | PB-AXISPRO-KPL250C1 | 162 |
| PA-ZASVELLO-CN-10   | 380      | PB-0FPO18-450       | 128 | PB-45-002X20-60A           | 278      | PB-AXISPRO-KPL250D  | 162 |
| PA-ZASVELLO-CN-20M  | 380      | PB-0FPO18-500       | 128 | PB-45-0010X3-60A           | 277      | PB-AXISPRO-KPL250D1 | 162 |
| PA-ZASVELLO-CN-21   | 380      | PB-0FPO18-550       | 128 | PB-45-202X10-60A           | 278, 282 | PB-AXISPRO-KPL300A  | 161 |
| PA-ZASVELLO-CP-05   | 380      | PB-0FPO18-600       | 128 | PB-45-400MF-2X16-60A       | 276      | PB-AXISPRO-KPL300A1 | 161 |
| PA-ZASVELLO-CP-06   | 380      | PB-0SHX-250-A       | 124 | PB-45-450-2X20-60A         | 282      | PB-AXISPRO-KPL300B  | 161 |
| PA-ZASVELLO-CP-21   | 380      | PB-0SHX-270-A       | 124 | PB-45-450MF202X10-60A      | 283      | PB-AXISPRO-KPL300B1 | 161 |
| PA-ZASVELLO-LNL-05  | 378      | PB-0SHX-300-A       | 124 | PB-45-600MF-2X27-60A       | 285      | PB-AXISPRO-KPL300C  | 162 |
| PA-ZASVELLO-LNL-06  | 378      | PB-0SHX-350-A       | 124 | PB-45-002010-60A           | 277      | PB-AXISPRO-KPL300C1 | 162 |
| PA-ZASVELLO-LNL-10  | 378      | PB-0SHX-400-A       | 124 | PB-45-MF2X15-60A           | 281      | PB-AXISPRO-KPL300D  | 162 |
| PA-ZASVELLO-LNL-20M | 378      | PB-0SHX-450-A       | 124 | PB-45-MF002X20-60A279, 283 |          | PB-AXISPRO-KPL300D1 | 162 |
| PA-ZASVELLO-LNL-21  | 378      | PB-0SHX-500-A       | 124 | PB-45-MF2X34-60A           | 284      | PB-AXISPRO-KPL350A  | 161 |
| PA-ZASVELLO-LNP-05  | 378      | PB-0SHX-550-A       | 124 | PB-45-MF202X10-60A         | 279      | PB-AXISPRO-KPL350A1 | 161 |
| PA-ZASVELLO-LNP-06  | 378      | PB-0SHX-600-A       | 124 | PB-45-MF342X17-60A         | 284      | PB-AXISPRO-KPL350B  | 161 |
| PA-ZASVELLO-LNP-10  | 378      | PB-3D0FPO18-250-PRO | 126 | PB-91024160V               | 287      | PB-AXISPRO-KPL350B1 | 161 |
| PA-ZASVELLO-LNP-20M | 378      | PB-3D0FPO18-300-PRO | 126 | PB-AS-600-1X15L-2X7L       | 286      | PB-AXISPRO-KPL350C  | 162 |
| PA-ZASVELLO-LNP-21  | 378      | PB-3D0FPO18-350-PRO | 126 | PB-AS-600-1X15L-3X7L       | 286      | PB-AXISPRO-KPL350C1 | 162 |
| PA-ZASVELLO-LPL-05  | 378      | PB-3D0FPO18-400-PRO | 126 | PB-AS-600-2X15L            | 286      | PB-AXISPRO-KPL350D  | 162 |
| PA-ZASVELLO-LPL-06  | 378      | PB-3D0FPO18-450-PRO | 126 | PB-AS-600-2X15L-2X7L       | 286      | PB-AXISPRO-KPL350D1 | 162 |
| PA-ZASVELLO-LPL-10  | 378      | PB-3D0FPO18-500-PRO | 126 | PB-AS-700-2X15L-2X7L       | 286      | PB-AXISPRO-KPL400A  | 161 |
| PA-ZASVELLO-LPL-20M | 378      | PB-3D0FPO18-550-PRO | 126 | PB-AS-800-2X15L-2X7L       | 286      | PB-AXISPRO-KPL400A1 | 161 |
| PA-ZASVELLO-LPL-21  | 378      | PB-3D0FPO18-600-PRO | 126 | PB-AS-800-4X15L            | 286      | PB-AXISPRO-KPL400B  | 161 |
| PA-ZASVELLO-LPP-05  | 378      | PB-3D0SHX18-250-H   | 123 | PB-AS-900-4X15L            | 286      | PB-AXISPRO-KPL400B1 | 161 |
| PA-ZASVELLO-LPP-06  | 378      | PB-3D0SHX18-300-H   | 123 | PB-AXISPRO-KPL69-450-10    |          | PB-AXISPRO-KPL400C  | 162 |
| PA-ZASVELLO-LPP-10  | 378      | PB-3D0SHX18-300-PRO | 122 | 163                        |          | PB-AXISPRO-KPL400C1 | 162 |
| PA-ZASVELLO-LPP-20M | 378      | PB-3D0SHX18-350-H   | 123 | PB-AXISPRO-KPL69-450-60    |          | PB-AXISPRO-KPL400D  | 162 |
| PA-ZASVELLO-LPP-21  | 378      | PB-3D0SHX18-350-PRO | 122 | 163                        |          | PB-AXISPRO-KPL400D1 | 162 |
| PA-ZASVELO-CP-10    | 380      | PB-3D0SHX18-400-H   | 123 | PB-AXISPRO-KPL69-500-10    |          | PB-AXISPRO-KPL450A  | 161 |
| PA-ZASVELO-CP-20M   | 380      | PB-3D0SHX18-400-PRO | 122 | 163                        |          | PB-AXISPRO-KPL450A1 | 161 |
| PA-ZAWGLAXDR-00     | 548, 549 | PB-3D0SHX18-450-H   | 123 | PB-AXISPRO-KPL69-500-60    |          | PB-AXISPRO-KPL450B  | 161 |
| PA-ZGLAXKTOMZ-00    | 563      | PB-3D0SHX18-450-PRO | 122 | 163                        |          | PB-AXISPRO-KPL450B1 | 161 |
| PA-ZGLAXMNKOMZ-00   | 562      | PB-3D0SHX18-500-H   | 123 | PB-AXISPRO-KPL250A         | 161      | PB-AXISPRO-KPL450C  | 162 |
| PA-ZGLAXOMZ-00      | 562      | PB-3D0SHX18-500-PRO | 122 | PB-AXISPRO-KPL250A1        | 161      | PB-AXISPRO-KPL450C1 | 162 |
| PB-0FPO18-250       | 128      | PB-3D0SHX18-550-H   | 123 | PB-AXISPRO-KPL250B         | 161      | PB-AXISPRO-KPL450D  | 162 |
| PB-0FPO18-300       | 128      | PB-3D0SHX18-550-PRO | 122 | PB-AXISPRO-KPL250B1        | 161      | PB-AXISPRO-KPL450D1 | 162 |
| PB-0FPO18-350       | 128      | PB-3D0SHX18-600-H   | 123 | PB-AXISPRO-KPL250C         | 162      | PB-AXISPRO-KPL500A  | 161 |

|                         |     |                         |     |                         |     |                        |
|-------------------------|-----|-------------------------|-----|-------------------------|-----|------------------------|
| PB-AXISPRO-KPL500A1     | 161 | PB-AXISPRO-P20-KPL300C1 | 164 | PB-AXISPRO-P20-KPL550A1 | 163 | PB-AXISPRO-SYNCHRO-P20 |
| PB-AXISPRO-KPL500B      | 161 | PB-AXISPRO-P20-KPL300D  | 165 | PB-AXISPRO-P20-KPL550B  | 164 | 163, 164, 165          |
| PB-AXISPRO-KPL500B1     | 161 | PB-AXISPRO-P20-KPL300D1 | 165 | PB-AXISPRO-P20-KPL550B1 | 164 | PB-AXISPRO-SYNCHRO-P20 |
| PB-AXISPRO-KPL500C      | 162 | PB-AXISPRO-P20-KPL350A  | 163 | PB-AXISPRO-P20-KPL550C  | 164 | -MOC 163, 164, 165     |
| PB-AXISPRO-KPL500C1     | 162 | PB-AXISPRO-P20-KPL350A1 | 163 | PB-AXISPRO-P20-KPL550C1 | 164 | PB-AXISPRO-WEWMOCA 165 |
| PB-AXISPRO-KPL500D      | 162 | PB-AXISPRO-P20-KPL350B  | 164 | PB-AXISPRO-P20-KPL550D  | 165 | PB-AXISPRO-WEWMOCA1165 |
| PB-AXISPRO-KPL500D1     | 162 | PB-AXISPRO-P20-KPL350B1 | 164 | PB-AXISPRO-P20-KPL550D1 | 165 | PB-AXISPRO-WEWMOCB 166 |
| PB-AXISPRO-KPL550A      | 161 | PB-AXISPRO-P20-KPL350C  | 164 | PB-AXISPRO-P20-KPL600A  | 163 | PB-AXISPRO-WEWMOCB1166 |
| PB-AXISPRO-KPL550A1     | 161 | PB-AXISPRO-P20-KPL350C1 | 164 | PB-AXISPRO-P20-KPL600A1 |     | PB-AXISPRO-WEWMOCC 166 |
| PB-AXISPRO-KPL550B      | 161 | PB-AXISPRO-P20-KPL350D  | 165 |                         | 163 | PB-AXISPRO-WEWMOCC1166 |
| PB-AXISPRO-KPL550B1     | 161 | PB-AXISPRO-P20-KPL350D1 | 165 | PB-AXISPRO-P20-KPL600B  | 164 | PB-AXISPRO-WEWMOCD 167 |
| PB-AXISPRO-KPL550C      | 162 | PB-AXISPRO-P20-KPL400A  | 163 | PB-AXISPRO-P20-KPL600B1 | 164 | PB-AXISPRO-WEWMOCD1167 |
| PB-AXISPRO-KPL550C1     | 162 | PB-AXISPRO-P20-KPL400A1 | 163 | PB-AXISPRO-P20-KPL600C  | 164 | PB-AXISPRO-ZESWEW-A1   |
| PB-AXISPRO-KPL550D      | 162 | PB-AXISPRO-P20-KPL400B  | 164 | PB-AXISPRO-P20          |     | AXISPRO 167            |
| PB-AXISPRO-KPL550D1     | 162 | PB-AXISPRO-P20-KPL400B1 | 164 | -KPL600C1               | 164 | PB-AXISPRO-ZESWEW-A    |
| PB-AXISPRO-KPL600A      | 161 | PB-AXISPRO-P20-KPL400C  | 164 | PB-AXISPRO-P20-KPL600D  |     | AXISPRO 167            |
| PB-AXISPRO-KPL600A1     | 161 | PB-AXISPRO-P20-KPL400C1 | 164 |                         | 165 | PB-AXISPRO-ZESWEW-B1   |
| PB-AXISPRO-KPL600B      | 161 | PB-AXISPRO-P20-KPL400D  | 165 | PB-AXISPRO-P20-KPL600D1 |     | AXISPRO 168            |
| PB-AXISPRO-KPL600B1     | 161 | PB-AXISPRO-P20-KPL400D1 | 165 |                         | 165 | PB-AXISPRO-ZESWEW-B    |
| PB-AXISPRO-KPL600C      | 162 | PB-AXISPRO-P20-KPL450A  | 163 | PB-AXISPRO-RELKW300     | 169 | AXISPRO 168            |
| PB-AXISPRO-KPL600C1     | 162 | PB-AXISPRO-P20-KPL450A1 | 163 | PB-AXISPRO-RELKW300-10  |     | PB-AXISPRO-ZESWEW-C1   |
| PB-AXISPRO-KPL600D      | 162 | PB-AXISPRO-P20-KPL450B  | 164 |                         | 169 | AXISPRO 168            |
| PB-AXISPRO-KPL600D1     | 162 | PB-AXISPRO-P20-KPL450B1 | 164 | PB-AXISPRO-RELKW350     | 169 | PB-AXISPRO-ZESWEW-C    |
| PB-AXISPRO-P20-KPL250A  | 163 | PB-AXISPRO-P20-KPL450C  | 164 | PB-AXISPRO-RELKW350-10  |     | AXISPRO 168            |
| PB-AXISPRO-P20-KPL250A1 | 163 | PB-AXISPRO-P20-KPL450C1 | 164 |                         | 169 | PB-AXISPRO-ZESWEW-D1   |
| PB-AXISPRO-P20-KPL250B  | 164 | PB-AXISPRO-P20-KPL450D  | 165 | PB-AXISPRO-RELKW400     | 169 | AXISPRO 169            |
| PB-AXISPRO-P20-KPL250B1 | 164 | PB-AXISPRO-P20-KPL450D1 | 165 | PB-AXISPRO-RELKW400-10  |     | PB-AXISPRO-ZESWEW-D    |
| PB-AXISPRO-P20-KPL250C  | 164 | PB-AXISPRO-P20-KPL500A  | 163 |                         | 169 | AXISPRO 169            |
| PB-AXISPRO-P20-KPL250C1 | 164 | PB-AXISPRO-P20-KPL500A1 | 163 | PB-AXISPRO-RELKW450     | 169 | PB-AXISPRO-ZNACZ       |
| PB-AXISPRO-P20-KPL250D  | 165 | PB-AXISPRO-P20-KPL500B  | 164 | PB-AXISPRO-RELKW450-10  |     | -FRONT 169             |
| PB-AXISPRO-P20-KPL250D1 | 165 | PB-AXISPRO-P20-KPL500B1 | 164 |                         | 169 | PB-D-BXSIDE45B 192     |
| PB-AXISPRO-P20-KPL300A  | 163 | PB-AXISPRO-P20-KPL500C  | 164 | PB-AXISPRO-RELKW500     | 169 | PB-D-BXSIDE45B-10 192  |
| PB-AXISPRO-P20-KPL300A1 | 163 | PB-AXISPRO-P20-KPL500C1 | 164 | PB-AXISPRO-RELKW500-10  |     | PB-D-BXSIDE45C 193     |
| PB-AXISPRO-P20-KPL300B  | 164 | PB-AXISPRO-P20-KPL500D  | 165 |                         | 169 | PB-D-BXSIDE45C-10 193  |
| PB-AXISPRO-P20-KPL300B1 | 164 | PB-AXISPRO-P20-KPL500D1 | 165 | PB-AXISPRO-RELKW550     | 169 | PB-D-BXSIDE50B 192     |
| PB-AXISPRO-P20-KPL300C  | 164 | PB-AXISPRO-P20-KPL550A  | 163 | PB-AXISPRO-RELKW550-10  | 169 | PB-D-BXSIDE50B-10 192  |

|                     |          |               |     |                    |          |                    |          |
|---------------------|----------|---------------|-----|--------------------|----------|--------------------|----------|
| PB-D-BXSIDE50C      | 193      | PB-D-KPL300B  | 184 | PB-D-MATRYCA       | 181, 195 | PB-D-RELCOV        | 190      |
| PB-D-BXSIDE50C-10   | 193      | PB-D-KPL300B1 | 184 | PB-D-MBSTAB-00     | 197      | PB-D-RELCOV-10     | 190      |
| PB-D-BXSIDEKW25C    | 178      | PB-D-KPL300C  | 184 | PB-D-MHG04         | 196      | PB-D-RELKW350      | 172      |
| PB-D-BXSIDEKW25C-10 | 178      | PB-D-KPL300C1 | 184 | PB-D-MHG04-KW      | 180      | PB-D-RELKW350-10   | 172      |
| PB-D-BXSIDEKW30C    | 178      | PB-D-KPL350A  | 183 | PB-D-N2R0-00       | 179, 193 | PB-D-RELKW400      | 172      |
| PB-D-BXSIDEKW30C-10 | 178      | PB-D-KPL350A1 | 183 | PB-D-N2R0-01       | 179, 193 | PB-D-RELKW400-10   | 172      |
| PB-D-BXSIDEKW35C    | 178      | PB-D-KPL350B  | 184 | PB-D-P20250A       | 183      | PB-D-RELKW450      | 172      |
| PB-D-BXSIDEKW35C-10 | 178      | PB-D-KPL350B1 | 184 | PB-D-P20300A       | 183      | PB-D-RELKW450-10   | 172      |
| PB-D-BXSIDEKW40C    | 178      | PB-D-KPL350C  | 184 | PB-D-P20300C       | 184      | PB-D-RELKW500      | 172      |
| PB-D-BXSIDEKW40C-10 | 178      | PB-D-KPL350C1 | 184 | PB-D-P20350A       | 183      | PB-D-RELKW500-10   | 172      |
| PB-D-BXSIDEKW45C    | 178      | PB-D-KPL400A  | 183 | PB-D-P20350C       | 184      | PB-D-RELKW550      | 172      |
| PB-D-BXSIDEKW45C-10 | 178      | PB-D-KPL400A1 | 183 | PB-D-P20400A       | 183      | PB-D-RELKW550-10   | 172      |
| PB-D-BXSIDEKW50C    | 178      | PB-D-KPL400B  | 184 | PB-D-P20400C       | 184      | PB-D-RP-1100       | 188      |
| PB-D-BXSIDEKW50C-10 | 178      | PB-D-KPL400B1 | 184 | PB-D-P20450A       | 183      | PB-D-RP-1100-10    | 188      |
| PB-D-BXSIDEKW55C    | 178      | PB-D-KPL400C  | 184 | PB-D-P20450C       | 184      | PB-D-S2R0-00       | 179, 194 |
| PB-D-BXSIDEKW55C-10 | 178      | PB-D-KPL400C1 | 184 | PB-D-P20500A       | 183      | PB-D-S2R0-01       | 179, 194 |
| PB-D-CONBXSID       | 191      | PB-D-KPL450A  | 183 | PB-D-P20500C       | 184      | PB-D-UCHWEW        | 189      |
| PB-D-CONBXSIDE-10   | 191      | PB-D-KPL450A1 | 183 | PB-D-P20550C       | 184      | PB-D-UCHWEW-10     | 189      |
| PB-D-CONREL         | 191      | PB-D-KPL450B  | 184 | PB-D-P20STAB       | 159      | PB-D-ULE-500       | 198      |
| PB-D-CONREL-10      | 191      | PB-D-KPL450B1 | 184 | PB-D-PRZEGLP       | 192      | PB-D-W2R0-00       | 180, 194 |
| PB-D-CONREL-KW      | 176      | PB-D-KPL450C  | 184 | PB-D-PRZEGLP-10    | 192      | PB-D-W2R0-01       | 180, 194 |
| PB-D-CONREL-KW-10   | 176      | PB-D-KPL450C1 | 184 | PB-D-PRZEGLP-KW    | 177      | PB-D-WEWMOCA       | 185      |
| PB-D-D2R0-00        | 177, 195 | PB-D-KPL500A  | 183 | PB-D-PRZEGLP-KW-10 | 177      | PB-D-WEWMOCA1      | 185      |
| PB-D-D2R0-01        | 177, 195 | PB-D-KPL500A1 | 183 | PB-D-REL300-10     | 185      | PB-D-WEWMOCA-KW    | 173      |
| PB-D-KPL68-450-10   | 197      | PB-D-KPL500B  | 184 | PB-D-REL350-10     | 185      | PB-D-WEWMOCA-KW-10 | 173      |
| PB-D-KPL68-450-80   | 197      | PB-D-KPL500B1 | 184 | PB-D-REL400-10     | 185      | PB-D-WEWMOCB       | 186      |
| PB-D-KPL68-500-10   | 197      | PB-D-KPL500C  | 184 | PB-D-REL450-10     | 185      | PB-D-WEWMOCB1      | 186      |
| PB-D-KPL68-500-80   | 197      | PB-D-KPL500C1 | 184 | PB-D-REL500-10     | 185      | PB-D-WEWMOCB-KW    | 173      |
| PB-D-KPL250A        | 183      | PB-D-KPL550A  | 183 | PB-D-REL550-10     | 185      | PB-D-WEWMOCB-KW-10 | 173      |
| PB-D-KPL250A1       | 183      | PB-D-KPL550A1 | 183 | PB-D-REL2500       | 185      | PB-D-WEWMOCC       | 187      |
| PB-D-KPL250B        | 184      | PB-D-KPL550B  | 184 | PB-D-REL3000       | 185      | PB-D-WEWMOCC1      | 187      |
| PB-D-KPL250B1       | 184      | PB-D-KPL550B1 | 184 | PB-D-REL3500       | 185      | PB-D-WEWMOCC-KW    | 174      |
| PB-D-KPL250C        | 184      | PB-D-KPL550C  | 184 | PB-D-REL4000       | 185      | PB-D-WEWMOCC-KW-10 | 174      |
| PB-D-KPL250C1       | 184      | PB-D-KPL550C1 | 184 | PB-D-REL4500       | 185      | PB-D-WEWORG-A      | 188      |
| PB-D-KPL300A        | 183      | PB-D-LR-00-0  | 190 | PB-D-REL5000       | 185      | PB-D-WEWORG-A-10   | 188      |
| PB-D-KPL300A1       | 183      | PB-D-LR-00-10 | 190 | PB-D-REL5500       | 185      | PB-D-WEWORG-B      | 188      |

|                    |          |                |     |                       |     |                          |     |
|--------------------|----------|----------------|-----|-----------------------|-----|--------------------------|-----|
| PB-D-WEWORG-B-10   | 188      | PB-KW-KPL300A1 | 171 | PB-KW-KPL600A1        | 171 | PD-GAM100-N02            | 111 |
| PB-D-WEWORGKW-A    | 175      | PB-KW-KPL300B  | 171 | PB-KW-KPL600B         | 171 | PD-GAM100-N10            | 111 |
| PB-D-WEWORGKW-A-10 | 175      | PB-KW-KPL300B1 | 171 | PB-KW-KPL600B1        | 171 | PD-GAM100-N60            | 111 |
| PB-D-WEWORGKW-B    | 176      | PB-KW-KPL300C  | 172 | PB-KW-KPL600C         | 172 | PD-GAM120-N02            | 111 |
| PB-D-WEWORGKW-B-10 | 176      | PB-KW-KPL300C1 | 172 | PB-KW-KPL600C1        | 172 | PD-GAM120-N10            | 111 |
| PB-D-WEWSZKLC      | 186      | PB-KW-KPL350A  | 171 | PB-SYNCHROP20-PRO     | 126 | PD-GAM120-N60            | 111 |
| PB-D-WEWSZKLC-10   | 186      | PB-KW-KPL350A1 | 171 | PB-SYNCHROP20-PRO-MOC |     | PD-GAM150-N02            | 111 |
| PB-D-ZESWEW-C      | 187      | PB-KW-KPL350B  | 171 |                       | 126 | PD-GAM150-N10            | 111 |
| PB-D-ZESWEW-C-10   | 187      | PB-KW-KPL350B1 | 171 | PB-SZABLON-AXIS-MB    | 199 | PD-GAM150-N60            | 111 |
| PB-D-ZESWEWKW-C    | 174      | PB-KW-KPL350C  | 172 | PB-WSPCOK             | 127 | PD-GNE012-50-10M         | 110 |
| PB-D-ZESWEWKW-C-10 | 174      | PB-KW-KPL350C1 | 172 | PD-ECGDL-060          | 120 | PD-GNE012-50-60          | 110 |
| PB-D-ZLE-450       | 198      | PB-KW-KPL400A  | 171 | PD-ECGDL-080          | 120 | PD-GNE012-60-10M         | 110 |
| PB-D-ZLE-500       | 198      | PB-KW-KPL400A1 | 171 | PD-ECGDL-150          | 120 | PD-GNE012-60-60          | 110 |
| PB-D-ZNACZ-0       | 181, 196 | PB-KW-KPL400B  | 171 | PD-G0050-N02          | 112 | PD-GNE012-80-10M         | 110 |
| PB-D-ZR-00-0       | 189      | PB-KW-KPL400B1 | 171 | PD-G0050-N03          | 113 | PD-GNE012-80-60          | 110 |
| PB-D-ZR-00-10      | 189      | PB-KW-KPL400C  | 172 | PD-G0060-N02          | 112 | PD-GPD01-001             | 115 |
| PB-D-ZR-KW-00      | 175      | PB-KW-KPL400C1 | 172 | PD-G0060-N03          | 113 | PD-GPD02-002             | 115 |
| PB-D-ZR-KW-10      | 175      | PB-KW-KPL450A  | 171 | PD-G0080-N02          | 112 | PD-GPD03-005             | 115 |
| PB-G10HX300-H      | 129      | PB-KW-KPL450A1 | 171 | PD-G0080-N03          | 113 | PD-LIFTNEW-LIGHT-10      | 108 |
| PB-G10HX-350       | 129      | PB-KW-KPL450B  | 171 | PD-G0100-N02          | 112 | PD-LIFTNEW-LIGHT-80      | 108 |
| PB-G10HX-450       | 129      | PB-KW-KPL450B1 | 171 | PD-G0100-N03          | 113 | PD-LIFTNEW-MEDIUM-10108  |     |
| PB-G10HX-500       | 129      | PB-KW-KPL450C  | 172 | PD-G0120-N02          | 112 | PD-LIFTNEW-MEDIUM-80108  |     |
| PB-G10HX-550       | 129      | PB-KW-KPL450C1 | 172 | PD-G0120-N03          | 113 | PD-LIFTNEW-STRONG-10108  |     |
| PB-GCHX18-300-H    | 125      | PB-KW-KPL500A  | 171 | PD-G0150-N02          | 112 | PD-LIFTNEW-STRONG-80108  |     |
| PB-GCHX18-350-H    | 125      | PB-KW-KPL500A1 | 171 | PD-G0150-N03          | 113 | PD-LIFTNEW-STRONG        |     |
| PB-GCHX18-400-H    | 125      | PB-KW-KPL500B  | 171 | PD-G60160-02          | 114 | -PLUS-10                 | 108 |
| PB-GCHX18-450-H    | 125      | PB-KW-KPL500B1 | 171 | PD-G80160-02          | 114 | PD-LIFT-P20-LIGHT-10     | 108 |
| PB-GCHX18-500-H    | 125      | PB-KW-KPL500C  | 172 | PD-GAM050-N02         | 111 | PD-LIFT-P20-LIGHT-80     | 108 |
| PB-GCHX18-550-H    | 125      | PB-KW-KPL500C1 | 172 | PD-GAM050-N10         | 111 | PD-LIFT-P20-MEDIUM-10108 |     |
| PB-KW-KPL250A      | 171      | PB-KW-KPL550A  | 171 | PD-GAM050-N60         | 111 | PD-LIFT-P20-MEDIUM-80108 |     |
| PB-KW-KPL250A1     | 171      | PB-KW-KPL550A1 | 171 | PD-GAM060-N02         | 111 | PD-LIFT-P20-STRONG-10108 |     |
| PB-KW-KPL250B      | 171      | PB-KW-KPL550B  | 171 | PD-GAM060-N10         | 111 | PD-LIFT-P20-STRONG-80108 |     |
| PB-KW-KPL250B1     | 171      | PB-KW-KPL550B1 | 171 | PD-GAM060-N60         | 111 | PD-LIFT-P20-STRONG       |     |
| PB-KW-KPL250C      | 172      | PB-KW-KPL550C  | 172 | PD-GAM080-N02         | 111 | -PLUS-10                 | 108 |
| PB-KW-KPL250C1     | 172      | PB-KW-KPL550C1 | 172 | PD-GAM080-N10         | 111 | PD-LIFT-P20-STRONG       |     |
| PB-KW-KPL300A      | 171      | PB-KW-KPL600A  | 171 | PD-GAM080-N60         | 111 | -PLUS-80                 | 108 |

|                       |     |                |     |                 |     |                 |     |
|-----------------------|-----|----------------|-----|-----------------|-----|-----------------|-----|
| PD-MDLIFT-P1-D        | 118 | PG-ST83115-60  | 260 | PK-0-H45-600    | 139 | PK-0H45450GX2-A | 146 |
| PD-MDLIFT-P2-D        | 119 | PG-ST8311520   | 274 | PK-0-H45-700    | 139 | PK-0H45450HK    | 144 |
| PD-MD-ZB-01-KPL       | 101 | PK-0-000-027   | 152 | PK-0-H53-300    | 130 | PK-0H45500GX1   | 143 |
| PD-MD-ZB-04-KPL       | 101 | PK-0H27-3000   | 151 | PK-0-H53-350    | 130 | PK-0H45500GX2-A | 146 |
| PD-MINILIFTNEW-LIGHT  | 109 | PK-0H27-3500   | 151 | PK-0-H53-400    | 130 | PK-0H45500HK    | 144 |
| PD-MINILIFTNEW        |     | PK-0H27-4000   | 151 | PK-0-H53-450    | 130 | PK-0H45550GX1   | 143 |
| -LIGHT-20             | 109 | PK-0H27-4500   | 151 | PK-0-H53-500    | 130 | PK-0H45550GX2-A | 146 |
| PD-MINILIFTNEW-MEDIUM |     | PK-0H27-5000   | 151 | PK-0-H53-550    | 130 | PK-0H45550HK    | 144 |
|                       | 109 | PK-0H30-2500   | 149 | PK-0-H53-600    | 130 | PK-0H45600GX1   | 143 |
| PD-MINILIFTNEW        |     | PK-0H30-2500-A | 150 | PK-0-H53-650    | 130 | PK-0H45600GX2-A | 146 |
| -MEDIUM-20            | 109 | PK-0H30-3000   | 149 | PK-0-H53-700    | 130 | PK-0H45600HK    | 144 |
| PD-MINILIFTNEW        |     | PK-0H30-3000-A | 150 | PK-0-H53-750    | 130 | PK-0H45650GX1   | 143 |
| -STRONG               | 109 | PK-0H30-3500   | 149 | PK-0-H53-800    | 130 | PK-0H45650GX2-A | 146 |
| PD-MINILIFTNEW        |     | PK-0H30-3500-A | 150 | PK-0-H53-900    | 130 | PK-0H45650HK    | 144 |
| -STRONG-20            | 109 | PK-0H30-4000   | 149 | PK-0-H53-1000   | 130 | PK-0H45700GX1   | 143 |
| PD-PD000-001          | 116 | PK-0H30-4000-A | 150 | PK-0-H53-1100   | 130 | PK-0H45700GX2-A | 146 |
| PD-PD000-001B         | 117 | PK-0H30-4500   | 149 | PK-0H17182XP    | 153 | PK-0H45700HK    | 144 |
| PG-AL4560-20          | 274 | PK-0-H35-2500  | 147 | PK-0H17214XP    | 153 | PK-0H45750HK    | 144 |
| PG-AL6083-20          | 274 | PK-0-H35-2500L | 148 | PK-0H17246XP    | 153 | PK-L-H45-250    | 134 |
| PG-AL8311520          | 274 | PK-0-H35-3000  | 147 | PK-0H17278XP    | 153 | PK-L-H45-250-A  | 136 |
| PG-GA4560-10          | 273 | PK-0-H35-3000L | 148 | PK-0H17310XP    | 153 | PK-L-H45-300    | 134 |
| PG-GA4560-20          | 273 | PK-0-H35-3500  | 147 | PK-0H17342XP    | 153 | PK-L-H45-300-A  | 136 |
| PG-GA6083-10          | 273 | PK-0-H35-3500L | 148 | PK-0H17406XP    | 153 | PK-L-H45-300-GX | 137 |
| PG-GA6083-20          | 273 | PK-0-H35-4000  | 147 | PK-0H17438XP    | 153 | PK-L-H45-350    | 134 |
| PG-GA83115-10         | 273 | PK-0-H35-4000L | 148 | PK-0H45250GX1   | 143 | PK-L-H45-350-A  | 136 |
| PG-GA8311520          | 273 | PK-0-H35-4500  | 147 | PK-0H45250HK    | 144 | PK-L-H45-350-GX | 137 |
| PG-ST4560-10          | 274 | PK-0-H35-4500L | 148 | PK-0H45300GX1   | 143 | PK-L-H45-400    | 134 |
| PG-ST4560-10A         | 260 | PK-0-H35-5000  | 147 | PK-0H45300GX2-A | 146 | PK-L-H45-400-A  | 136 |
| PG-ST4560-20          | 274 | PK-0-H35-5000L | 148 | PK-0H45300HK    | 144 | PK-L-H45-400-GX | 137 |
| PG-ST4560-60          | 260 | PK-0-H45-250   | 139 | PK-0H45350GX1   | 143 | PK-L-H45-450    | 134 |
| PG-ST6083-10          | 274 | PK-0-H45-300   | 139 | PK-0H45350GX2-A | 146 | PK-L-H45-450-A  | 136 |
| PG-ST6083-10A         | 260 | PK-0-H45-350   | 139 | PK-0H45350HK    | 144 | PK-L-H45-450-GX | 137 |
| PG-ST6083-20          | 274 | PK-0-H45-400   | 139 | PK-0H45400GX1   | 143 | PK-L-H45-500    | 134 |
| PG-ST6083-60          | 260 | PK-0-H45-450   | 139 | PK-0H45400GX2-A | 146 | PK-L-H45-500-A  | 136 |
| PG-ST83115-10         | 274 | PK-0-H45-500   | 139 | PK-0H45400HK    | 144 | PK-L-H45-500-GX | 137 |
| PG-ST83115-10A        | 260 | PK-0-H45-550   | 139 | PK-0H45450GX1   | 143 | PK-L-H45-550    | 134 |

|                  |     |               |     |               |     |                |     |
|------------------|-----|---------------|-----|---------------|-----|----------------|-----|
| PK-L-H45-550-A   | 136 | PK-S-H45-600  | 138 | PP-00GS03-01  | 205 | PP-NW12X120B   | 216 |
| PK-L-H45-550-GX  | 137 | PK-S-H45-650  | 138 | PP-00GS03-02  | 205 | PP-NW14X120B   | 216 |
| PK-L-H45-600     | 134 | PK-S-H45-700  | 138 | PP-00GS03-05  | 205 | PP-NW14X140B   | 216 |
| PK-L-H45-600-A   | 136 | PM-LBFI60-01  | 302 | PP-00GS03-06  | 205 | PP-NW14X165B   | 216 |
| PK-L-H45-600-GX  | 137 | PM-LBFI60-02  | 302 | PP-00GS04-01  | 205 | PP-P04570-20   | 272 |
| PK-L-P20-H45-300 | 132 | PM-LBFI60-05  | 302 | PP-00GS04-02  | 205 | PP-P80110-20   | 272 |
| PK-L-P20-H45-350 | 132 | PM-LBFI60-06  | 302 | PP-00GS04-05  | 205 | PP-PMONT0D-22  | 223 |
| PK-L-P20-H45-400 | 132 | PM-LBFI60-20M | 302 | PP-00GS04-06  | 205 | PP-PMONT0M-01  | 222 |
| PK-L-P20-H45-450 | 132 | PM-LBFI80-01  | 302 | PP-BAR-20M    | 436 | PP-PMONT0M-07  | 222 |
| PK-L-P20-H45-500 | 132 | PM-LBFI80-02  | 302 | PP-BELT-20M   | 430 | PP-PMONT0M-08  | 222 |
| PK-L-P20-H45-550 | 132 | PM-LBFI80-05  | 302 | PP-DP0105-06  | 204 | PP-PMONT0M-22  | 222 |
| PK-L-P20-H45-600 | 132 | PM-LBFI80-06  | 302 | PP-DP0105-01  | 204 | PP-ROD-20M     | 436 |
| PK-L-P20-H45-700 | 132 | PM-LBFI80-20M | 302 | PP-DP0105-02  | 204 | PP-S0L003-01T  | 208 |
| PK-P-H45-300-GX  | 142 | PM-NAR1004-10 | 224 | PP-DP0105-05  | 204 | PP-S0L012-01T  | 209 |
| PK-P-H45-350-GX  | 142 | PM-NAR1004-11 | 224 | PP-FLAT-20M   | 430 | PP-SMART-000   | 216 |
| PK-P-H45-400-GX  | 142 | PM-NAR1004-19 | 224 | PP-GALA-20M   | 432 | PP-SP0075-01   | 203 |
| PK-P-H45-450-GX  | 142 | PM-PFMH50-24  | 232 | PP-GINO-20M   | 432 | PP-SP0075-02   | 203 |
| PK-P-H45-500-GX  | 142 | PM-PFMH50-25  | 232 | PP-GL-A48-01  | 206 | PP-SP0075-05   | 203 |
| PK-P-H45-550-GX  | 142 | PM-PFMH51-10  | 232 | PP-GL-B48-01  | 206 | PP-SP0075-06   | 203 |
| PK-P-H45-600-GX  | 142 | PM-PFMH55-25  | 232 | PP-GL-CGP-01  | 207 | PP-SPL001-01   | 215 |
| PK-PRO-H45-250   | 140 | PM-PFMH61-10  | 232 | PP-GL-DR5-01  | 214 | PP-TREE-20M    | 437 |
| PK-PRO-H45-300   | 140 | PM-PFMH64-25  | 232 | PP-GL-E410-01 | 207 | PP-WIRE-20M    | 437 |
| PK-PRO-H45-350   | 140 | PM-PLFI60-05  | 303 | PP-HS0006-01  | 209 | PR-0B-250-10   | 154 |
| PK-PRO-H45-400   | 140 | PM-PLFI60-10  | 303 | PP-HS2710-01  | 210 | PR-0B-250-18   | 154 |
| PK-PRO-H45-450   | 140 | PM-PLFI60-20  | 303 | PP-INGRID-20M | 434 | PR-0B-300-10   | 154 |
| PK-PRO-H45-500   | 140 | PM-PLFI60-30  | 303 | PP-LUK-00-01  | 217 | PR-0B-300-10-Z | 155 |
| PK-PRO-H45-550   | 140 | PM-PLFI60-43  | 303 | PP-LUK-00-02  | 217 | PR-0B-300-18   | 154 |
| PK-PRO-H45-600   | 140 | PM-PLFI60-45  | 303 | PP-LUK-00-05  | 217 | PR-0B-350-10   | 154 |
| PK-PRO-H45-650   | 140 | PM-PLFI60-47  | 303 | PP-MP0055-01  | 203 | PR-0B-350-10-Z | 155 |
| PK-S-H45-250     | 138 | PM-PLFI60-49  | 303 | PP-MP0055-02  | 203 | PR-0B-350-18   | 154 |
| PK-S-H45-300     | 138 | PM-PLFI60-50  | 303 | PP-MP0055-05  | 203 | PR-0B-350-18-Z | 155 |
| PK-S-H45-350     | 138 | PM-PLFI60-51  | 303 | PP-MP0055-06  | 203 | PR-0B-400-10   | 154 |
| PK-S-H45-400     | 138 | PP-00GS02-01  | 204 | PP-NEO-20M    | 434 | PR-0B-400-10-Z | 155 |
| PK-S-H45-450     | 138 | PP-00GS02-02  | 204 | PP-NW09X90B   | 216 | PR-0B-400-18   | 154 |
| PK-S-H45-500     | 138 | PP-00GS02-05  | 204 | PP-NW10X100B  | 216 | PR-0B-450-10   | 154 |
| PK-S-H45-550     | 138 | PP-00GS02-06  | 204 | PP-NW10X145B  | 216 | PR-0B-450-10-Z | 155 |

|                |     |                 |     |                  |     |                  |     |
|----------------|-----|-----------------|-----|------------------|-----|------------------|-----|
| PR-0B-450-18   | 154 | RS-220160-01    | 364 | RS-TRIES-192-06  | 366 | UA-00-337320     | 343 |
| PR-0B-450-80-Z | 155 | RS-220160-02    | 364 | RS-TRIES-256-06  | 366 | UA-00-337320-20M | 343 |
| PR-0B-500-10   | 154 | RS-220160-05    | 364 | RS-TRIES-320-06  | 366 | UA-00-338128     | 343 |
| PR-0B-500-18   | 154 | RS-220160-06    | 364 |                  |     | UA-00-338160     | 343 |
| PR-0B-550-10   | 154 | RS-220160-14    | 364 | <b>S</b>         |     | UA-00-340128     | 344 |
| PR-0B-550-18   | 154 | RS-272192-01    | 364 | SB-A60x72-20M    | 475 | UA-00-340160     | 344 |
| PR-0B-600-10   | 154 | RS-272192-02    | 364 | SB-A60X72-80     | 475 | UA-00-340192     | 344 |
| PR-0B-600-18   | 154 | RS-272192-05    | 364 | SZ-005-00-01-AT  | 229 | UA-00-340224     | 344 |
| PU-KEY027-20   | 298 | RS-272192-06    | 364 | SZ-005-00-01T    | 229 | UA-00-340256     | 344 |
| PU-KEY027-60   | 298 | RS-272192-14    | 364 | SZ-008-00-01-AT  | 229 | UA-00-340320     | 344 |
| PU-KEYM27-20   | 298 | RS-304224-01    | 364 | SZ-008-00-01T    | 229 | UA-00-347128     | 344 |
| PU-KEYM27-60   | 298 | RS-304224-02    | 364 | <b>U</b>         |     | UA-00-347160     | 344 |
| PU-PKO-00-20   | 299 | RS-304224-05    | 364 | UA-00-313128     | 338 | UA-00-347192     | 344 |
| PU-PKO-00-60   | 299 | RS-304224-06    | 364 | UA-00-313160     | 338 | UA-00-347224     | 344 |
|                |     | RS-304224-14    | 364 | UA-00-313192     | 338 | UA-00-347256     | 344 |
| <b>R</b>       |     | RS-336256-01    | 364 | UA-00-319096     | 339 | UA-00-347320     | 344 |
| RR-161030H01   | 237 | RS-336256-02    | 364 | UA-00-319128     | 339 | UA-01-326096-V1  | 367 |
| RR-161230H01   | 237 | RS-336256-05    | 364 | UA-00-319160     | 339 | UA-01-326128-V1  | 367 |
| RR-250730H01   | 237 | RS-336256-06    | 364 | UA-00-326096-05  | 367 | UA-01-326160     | 367 |
| RR-250830H01   | 237 | RS-336256-14    | 364 | UA-00-326096-20M | 367 | UA-18-128146     | 338 |
| RR-250930H01   | 237 | RS-368288-01    | 364 | UA-00-326128-05  | 367 | UA-18-160178     | 338 |
| RR-251030H01   | 237 | RS-368288-02    | 364 | UA-00-326128-20M | 367 | UA-18-192210     | 338 |
| RR-401230H01   | 237 | RS-368288-05    | 364 | UA-00-326160     | 367 | UA-18-224242     | 338 |
| RR-501030H01   | 237 | RS-368288-06    | 364 | UA-00-326160-20M | 367 | UA-18-256274     | 338 |
| RR-501230H01   | 237 | RS-368288-14    | 364 | UA-00-337096     | 343 | UA-18-320338     | 338 |
| RR-CH-OW-000   | 235 | RS-400320-01    | 364 | UA-00-337096-20M | 343 | UA-18-400418     | 338 |
| RS-156096-01   | 364 | RS-400320-02    | 364 | UA-00-337128     | 343 | UA-A18128-01     | 338 |
| RS-156096-02   | 364 | RS-400320-05    | 364 | UA-00-337128-20M | 343 | UA-A18160-01     | 338 |
| RS-156096-05   | 364 | RS-400320-06    | 364 | UA-00-337160     | 343 | UA-A18192-01     | 338 |
| RS-156096-06   | 364 | RS-400320-14    | 364 | UA-00-337160-20M | 343 | UA-A18224-01     | 338 |
| RS-156096-14   | 364 | RS-SZ-400-10    | 158 | UA-00-337192     | 343 | UA-A18256-01     | 338 |
| RS-188128-01   | 364 | RS-SZ-450-10    | 158 | UA-00-337192-20M | 343 | UA-A18320-01     | 338 |
| RS-188128-02   | 364 | RS-SZ-500-10    | 158 | UA-00-337224     | 343 | UA-AA-114-05     | 337 |
| RS-188128-05   | 364 | RS-TRIES-96-06  | 366 | UA-00-337224-20M | 343 | UA-ARS096-20     | 320 |
| RS-188128-06   | 364 | RS-TRIES-128-06 | 366 | UA-00-337256     | 343 | UA-ARS128-20     | 320 |
| RS-188128-14   | 364 | RS-TRIES-160-06 | 366 | UA-00-337256-20M | 343 | UA-ARS160-20     | 320 |



|                   |     |                  |     |                     |     |                       |     |
|-------------------|-----|------------------|-----|---------------------|-----|-----------------------|-----|
| UA-ARS192-20      | 320 | UA-B31132001     | 336 | UA-HEXI-128-05      | 370 | UA-LIND-256-296-20M   | 369 |
| UA-ARS224-20      | 320 | UA-B31148001*    | 336 | UA-HEXI-128-10M     | 370 | UA-LIND-256-596-01    | 369 |
| UA-ARS256-20      | 320 | UA-DOPPIO192-01  | 339 | UA-HEXI-128-20M     | 370 | UA-LIND-256-596-05    | 369 |
| UA-ARS320-20      | 320 | UA-DOPPIO416-01  | 339 | UA-HEXI-160-01      | 370 | UA-LIND-256-596-18    | 369 |
| UA-ARSG30-20      | 320 | UA-HEXA-32-01    | 372 | UA-HEXI-160-05      | 370 | UA-LIND-256-596-20M   | 369 |
| UA-B0-311096      | 336 | UA-HEXA-32-05    | 372 | UA-HEXI-160-10M     | 370 | UA-LIND-320-396-01    | 369 |
| UA-B0-311096-20M  | 336 | UA-HEXA-32-10M   | 372 | UA-HEXI-160-18      | 370 | UA-LIND-320-396-05    | 369 |
| UA-B0-311128      | 336 | UA-HEXA-32-18    | 372 | UA-HEXI-160-20M     | 370 | UA-LIND-320-396-18    | 369 |
| UA-B0-311128-20M  | 336 | UA-HEXA-32-20M   | 372 | UA-HEXI-160-60      | 370 | UA-LIND-320-396-20M   | 369 |
| UA-B0-311160      | 336 | UA-HEXA-96-01    | 372 | UA-HEXI192-01       | 370 | UA-LIND-352-796-01    | 369 |
| UA-B0-311160-20M  | 336 | UA-HEXA-96-05    | 372 | UA-HEXI192-05       | 370 | UA-LIND-352-796-05    | 369 |
| UA-B0-311192      | 336 | UA-HEXA-96-10M   | 372 | UA-HEXI192-10M      | 370 | UA-LIND-352-796-18    | 369 |
| UA-B0-311192-20M  | 336 | UA-HEXA-96-18    | 372 | UA-HEXI192-18       | 370 | UA-LIND-352-796-20M   | 369 |
| UA-B0-311224      | 336 | UA-HEXA-96-20M   | 372 | UA-HEXI192-20M      | 370 | UA-PICADO-224-496-01  | 374 |
| UA-B0-311224-20M  | 336 | UA-HEXA-192-01   | 372 | UA-HEXI192-60       | 370 | UA-PICADO-224-496-05  | 374 |
| UA-B0-311256      | 336 | UA-HEXA-192-05   | 372 | UA-HEXI-256-01      | 370 | UA-PICADO-224-496-18  | 374 |
| UA-B0-311256-20M  | 336 | UA-HEXA-192-10M  | 372 | UA-HEXI-256-05      | 370 | UA-PICADO-224-496-20M | 374 |
| UA-B0-311288      | 336 | UA-HEXA-192-18   | 372 | UA-HEXI-256-10M     | 370 | UA-PICADO-256-296-01  | 374 |
| UA-B0-311288-20M* | 336 | UA-HEXA-192-20M  | 372 | UA-HEXI-256-20M     | 370 | UA-PICADO-256-296-05  | 374 |
| UA-B0-311320      | 336 | UA-HEXA-1200-05  | 372 | UA-HEXI-290-18      | 370 | UA-PICADO-256-296-18  | 374 |
| UA-B0-311320-20M  | 336 | UA-HEXA-1200-10M | 372 | UA-HEXI-290-60      | 370 | UA-PICADO-256-296-20M | 374 |
| UA-B0-311480      | 336 | UA-HEXA-1200-20M | 372 | UA-HEXI-320-01      | 370 | UA-PICADO-256-596-01  | 374 |
| UA-B0-311480-20M* | 336 | UA-HEXA-1200-22  | 372 | UA-HEXI-320-05      | 370 | UA-PICADO-256-596-05  | 374 |
| UA-B0-337128      | 337 | UA-HEXI-01       | 370 | UA-HEXI-320-10M     | 370 | UA-PICADO-256-596-18  | 374 |
| UA-B0-337160      | 337 | UA-HEXI-05       | 370 | UA-HEXI-320-20M     | 370 | UA-PICADO-256-596-20M | 374 |
| UA-B0-337192      | 337 | UA-HEXI-10M      | 370 | UA-HEXI-360-18      | 370 | UA-PICADO-320-396-01  | 374 |
| UA-B0-337224      | 337 | UA-HEXI-18       | 370 | UA-HEXI-360-60      | 370 | UA-PICADO-320-396-05  | 374 |
| UA-B0-337256      | 337 | UA-HEXI-20M      | 370 | UA-HEXI-3500-05     | 370 | UA-PICADO-320-396-18  | 374 |
| UA-B0-337320      | 337 | UA-HEXI-60       | 370 | UA-HEXI-3500-20M    | 370 | UA-PICADO-320-396-20M | 374 |
| UA-B31109601*     | 336 | UA-HEXI96-01     | 370 | UA-LIND-224-496-01  | 369 | UA-PICADO-352-796-01  | 374 |
| UA-B31112801      | 336 | UA-HEXI96-05     | 370 | UA-LIND-224-496-05  | 369 | UA-PICADO-352-796-05  | 374 |
| UA-B31116001      | 336 | UA-HEXI96-10M    | 370 | UA-LIND-224-496-18  | 369 | UA-PICADO-352-796-18  | 374 |
| UA-B31119201      | 336 | UA-HEXI96-18     | 370 | UA-LIND-224-496-20M | 369 | UA-PICADO-352-796-20M | 374 |
| UA-B31122401      | 336 | UA-HEXI96-20M    | 370 | UA-LIND-256-296-01  | 369 | UA-STRUCTURE-128-20M  | 356 |
| UA-B31125601      | 336 | UA-HEXI96-60     | 370 | UA-LIND-256-296-05  | 369 | UA-STRUCTURE-192-20M  | 356 |
| UA-B31128801*     | 336 | UA-HEXI-128-01   | 370 | UA-LIND-256-296-18  | 369 | UA-TREX-32-50-05      | 375 |

|                     |          |                 |     |               |     |              |     |
|---------------------|----------|-----------------|-----|---------------|-----|--------------|-----|
| UA-TREX-32-50-20M   | 375      | UP-WP0728-BB    | 386 | UZ-05-128-05  | 357 | UZ-334256-06 | 328 |
| UA-TREX-96-150-05   | 375      | UP-WP0728-BK    | 386 | UZ-06-128-01  | 358 | UZ-334320-06 | 328 |
| UA-TREX-96-150-20M  | 375      | UP-WP0728-BR    | 386 | UZ-06-128-02  | 358 | UZ-336128-06 | 328 |
| UA-TREX-224-250-05  | 375      | UP-WP0728-BX    | 386 | UZ-06-128-05  | 358 | UZ-336160-06 | 328 |
| UA-TREX-224-250-20M | 375      | UP-WP0728-P0    | 387 | UZ-07-096-01  | 358 | UZ-336192-06 | 328 |
| UA-TREX-320-350-05  | 375      | UP-WP0728-PA-04 | 387 | UZ-07-096-02  | 358 | UZ-336256-06 | 328 |
| UA-TREX-320-350-20M | 375      | UP-WP0728-PA-07 | 387 | UZ-07-096-05  | 358 | UZ-336320-06 | 328 |
| UA-TREX-3500-05     | 375      | UP-WP0728-PB    | 387 | UZ-10-096-N04 | 389 | UZ-336416-06 | 328 |
| UA-TREX-3500-20M    | 375      | UP-WP0728-PC-04 | 387 | UZ-12-096-04  | 389 | UZ-336480-06 | 328 |
| UM-BLOCK-CZ         | 408, 429 | UP-WP0728-PK    | 387 | UZ-12-096-04N | 389 | UZ-682128-06 | 329 |
| UM-BLOCK-NB         | 408      | UP-WP0728-PR    | 387 | UZ-12-096-20M | 389 | UZ-682160-06 | 329 |
| UM-BLOCK-ZL         | 408      | UP-WP0728-PX    | 387 | UZ-13-096-01  | 359 | UZ-682192-06 | 329 |
| UM-BUTTON-NB        | 408      | UZ-00B224-01    | 368 | UZ-13-096-02  | 359 | UZ-682224-06 | 329 |
| UM-BUTTON-SZ        | 408      | UZ-00B224-02    | 368 | UZ-13-096-05  | 359 | UZ-682256-06 | 329 |
| UM-CLOUD-NB         | 408      | UZ-00B224-05    | 368 | UZ-14-096-01  | 360 | UZ-682320-06 | 329 |
| UM-CLOUD-SZ         | 408      | UZ-00B224-10    | 368 | UZ-14-096-02  | 360 | UZ-682416-06 | 329 |
| UM-CROWN-RZ         | 408      | UZ-00B224-20    | 368 | UZ-14-096-05  | 360 | UZ-682480-06 | 329 |
| UM-FLAMING-RZ       | 408      | UZ-00B226-01    | 368 | UZ-14-128-01  | 360 | UZ-819096-01 | 332 |
| UM-FLAMING-SZ       | 408      | UZ-00B226-02    | 368 | UZ-14-128-02  | 360 | UZ-819096-02 | 332 |
| UM-HEART-RZ         | 408      | UZ-00B226-05    | 368 | UZ-14-128-05  | 360 | UZ-819096-05 | 332 |
| UM-KID-C-001        | 410      | UZ-00B226-10    | 368 | UZ-40-032-01  | 325 | UZ-819096-06 | 332 |
| UM-KID-D-001        | 410      | UZ-00B226-20    | 368 | UZ-40-032-02  | 325 | UZ-819096-07 | 332 |
| UM-KID-E-001        | 410      | UZ-01-096-01    | 357 | UZ-40-032-05  | 325 | UZ-819096-10 | 332 |
| UM-KID-I-002        | 410      | UZ-01-096-02    | 357 | UZ-40-032-06  | 325 | UZ-819096-12 | 332 |
| UM-KID-P-001        | 410      | UZ-01-096-05    | 357 | UZ-40-032-20M | 325 | UZ-819096-14 | 332 |
| UM-KID-Q-001        | 410      | UZ-01-128-01    | 357 | UZ-55-025-05  | 325 | UZ-819096-20 | 332 |
| UM-KID-U-001        | 410      | UZ-01-128-02    | 357 | UZ-60-032-01  | 326 | UZ-819128-01 | 332 |
| UM-KID-W-001        | 411      | UZ-01-128-05    | 357 | UZ-71C096-01  | 402 | UZ-819128-02 | 332 |
| UM-KID-X-001        | 411      | UZ-02C064-01    | 403 | UZ-133128-01  | 326 | UZ-819128-05 | 332 |
| UM-KID-Z-001        | 411      | UZ-02C096-01    | 403 | UZ-133128-02  | 326 | UZ-819128-06 | 332 |
| UM-STAR-NB          | 408      | UZ-02CF27-01    | 403 | UZ-133128-05  | 326 | UZ-819128-07 | 332 |
| UM-STAR-RZ          | 408      | UZ-05-096-01    | 357 | UZ-133128-06  | 326 | UZ-819128-10 | 332 |
| UM-STAR-ZT          | 408      | UZ-05-096-02    | 357 | UZ-133128-20M | 326 | UZ-819128-12 | 332 |
| UM-TWITT-SZ         | 408      | UZ-05-096-05    | 357 | UZ-334128-06  | 328 | UZ-819128-14 | 332 |
| UM-TWITT-ZL         | 408      | UZ-05-128-01    | 357 | UZ-334160-06  | 328 | UZ-819128-15 | 332 |
| UM-UNICORN-RZ       | 411      | UZ-05-128-02    | 357 | UZ-334192-06  | 328 | UZ-819128-16 | 332 |

|              |     |                  |     |                   |     |                  |     |
|--------------|-----|------------------|-----|-------------------|-----|------------------|-----|
| UZ-819128-20 | 332 | UZ-819320-05     | 332 | UZ-BAGIO-160-07   | 323 | UZ-CAMAI-96-90   | 360 |
| UZ-819160-01 | 332 | UZ-819320-06     | 332 | UZ-BAGIO-160-11   | 323 | UZ-CAMAI-128-01  | 360 |
| UZ-819160-02 | 332 | UZ-819320-07     | 332 | UZ-BAGIO-160-15   | 323 | UZ-CAMAI-128-02  | 360 |
| UZ-819160-05 | 332 | UZ-819320-10     | 332 | UZ-BAGIO-160-20M  | 323 | UZ-CAMAI-128-06  | 360 |
| UZ-819160-06 | 332 | UZ-819320-12     | 332 | UZ-BAGIO-160-90   | 323 | UZ-CAMAI-128-09  | 360 |
| UZ-819160-07 | 332 | UZ-819320-14     | 332 | UZ-BAGIO-192-01   | 323 | UZ-CAMAI-128-10M | 360 |
| UZ-819160-10 | 332 | UZ-819320-20     | 332 | UZ-BAGIO-192-04   | 323 | UZ-CAMAI-128-12  | 360 |
| UZ-819160-12 | 332 | UZ-ABIAT-128-04  | 393 | UZ-BAGIO-192-05   | 323 | UZ-CAMAI-128-20M | 360 |
| UZ-819160-14 | 332 | UZ-ACERA-96-04   | 394 | UZ-BAGIO-192-06   | 323 | UZ-CAMAI-128-90  | 360 |
| UZ-819160-15 | 332 | UZ-ADRIN-96-04   | 393 | UZ-BAGIO-192-07   | 323 | UZ-CAPRI-96-01   | 331 |
| UZ-819160-16 | 332 | UZ-ALATR-128-04  | 387 | UZ-BAGIO-192-11   | 323 | UZ-CAPRI-96-02   | 331 |
| UZ-819160-20 | 332 | UZ-ANCON-128-01  | 324 | UZ-BAGIO-192-15   | 323 | UZ-CAPRI-96-05   | 331 |
| UZ-819192-01 | 332 | UZ-ANCON-128-05  | 324 | UZ-BAGIO-192-20M  | 323 | UZ-CAPRI-96-06   | 331 |
| UZ-819192-02 | 332 | UZ-ANCON-128-06  | 324 | UZ-BAGIO-192-90   | 323 | UZ-CAPRI-128-01  | 331 |
| UZ-819192-05 | 332 | UZ-ANCON-192-01  | 324 | UZ-BAGIO-320-01   | 323 | UZ-CAPRI-128-02  | 331 |
| UZ-819192-06 | 332 | UZ-ANCON-192-05  | 324 | UZ-BAGIO-320-04   | 323 | UZ-CAPRI-128-05  | 331 |
| UZ-819192-07 | 332 | UZ-ANCON-192-06  | 324 | UZ-BAGIO-320-05   | 323 | UZ-CAPRI-128-06  | 331 |
| UZ-819192-10 | 332 | UZ-ANCON-256-01  | 324 | UZ-BAGIO-320-06   | 323 | UZ-CAPRI-128-20M | 331 |
| UZ-819192-12 | 332 | UZ-ANCON-256-05  | 324 | UZ-BAGIO-320-07   | 323 | UZ-CAPRI-160-01  | 331 |
| UZ-819192-14 | 332 | UZ-ANCON-256-06  | 324 | UZ-BAGIO-320-11   | 323 | UZ-CAPRI-160-02  | 331 |
| UZ-819192-15 | 332 | UZ-ARCH096-AEB   | 392 | UZ-BAGIO-320-15   | 323 | UZ-CAPRI-160-05  | 331 |
| UZ-819192-16 | 332 | UZ-ARDEA-96-09   | 391 | UZ-BAGIO-320-20M  | 323 | UZ-CAPRI-160-06  | 331 |
| UZ-819192-20 | 332 | UZ-AREZO-96-04   | 392 | UZ-BAGIO-320-90   | 323 | UZ-CAPRI-160-20M | 331 |
| UZ-819256-01 | 332 | UZ-BAGIO-128-01  | 323 | UZ-CALABRIA160-01 | 345 | UZ-CAPRI-192-01  | 331 |
| UZ-819256-02 | 332 | UZ-BAGIO-128-04  | 323 | UZ-CALABRIA160-06 | 345 | UZ-CAPRI-192-02  | 331 |
| UZ-819256-05 | 332 | UZ-BAGIO-128-05  | 323 | UZ-CALABRIA192-01 | 345 | UZ-CAPRI-192-05  | 331 |
| UZ-819256-06 | 332 | UZ-BAGIO-128-06  | 323 | UZ-CALABRIA192-06 | 345 | UZ-CAPRI-192-06  | 331 |
| UZ-819256-07 | 332 | UZ-BAGIO-128-07  | 323 | UZ-CALABRIA224-01 | 345 | UZ-CAPRI-192-20M | 331 |
| UZ-819256-10 | 332 | UZ-BAGIO-128-11  | 323 | UZ-CALABRIA224-06 | 345 | UZ-CAPRI-256-01  | 331 |
| UZ-819256-12 | 332 | UZ-BAGIO-128-15  | 323 | UZ-CAMAI-96-01    | 360 | UZ-CAPRI-256-02  | 331 |
| UZ-819256-14 | 332 | UZ-BAGIO-128-20M | 323 | UZ-CAMAI-96-02    | 360 | UZ-CAPRI-256-05  | 331 |
| UZ-819256-15 | 332 | UZ-BAGIO-128-90  | 323 | UZ-CAMAI-96-06    | 360 | UZ-CAPRI-256-06  | 331 |
| UZ-819256-16 | 332 | UZ-BAGIO-160-01  | 323 | UZ-CAMAI-96-09    | 360 | UZ-CAPRI-256-20M | 331 |
| UZ-819256-20 | 332 | UZ-BAGIO-160-04  | 323 | UZ-CAMAI-96-10M   | 360 | UZ-CAPRI-320-01  | 331 |
| UZ-819320-01 | 332 | UZ-BAGIO-160-05  | 323 | UZ-CAMAI-96-12    | 360 | UZ-CAPRI-320-02  | 331 |
| UZ-819320-02 | 332 | UZ-BAGIO-160-06  | 323 | UZ-CAMAI-96-20M   | 360 | UZ-CAPRI-320-05  | 331 |

|                     |     |                   |     |                 |     |                   |     |
|---------------------|-----|-------------------|-----|-----------------|-----|-------------------|-----|
| UZ-CAPRI-320-06     | 331 | UZ-FIORD-32-20M   | 375 | UZ-G1-160-01    | 346 | UZ-GENUA160-20M   | 345 |
| UZ-CLEO-128-01      | 334 | UZ-FLAVIO-96-01   | 342 | UZ-G1-160-05    | 346 | UZ-KATAN-320-01   | 324 |
| UZ-CLEO-128-05      | 334 | UZ-FLAVIO-96-06   | 342 | UZ-G1-160-06    | 346 | UZ-KATAN-320-12   | 324 |
| UZ-CLEO-128-06      | 334 | UZ-FLAVIO-96-16   | 342 | UZ-G1-160-13    | 346 | UZ-LUCCA128-01    | 405 |
| UZ-CLEO-160-01      | 334 | UZ-FLAVIO-96-20M  | 342 | UZ-G1-160-20M   | 346 | UZ-LUCCA160-01    | 405 |
| UZ-CLEO-160-05      | 334 | UZ-FLAVIO-128-01  | 342 | UZ-G1-192-01    | 346 | UZ-LUCCA192-01    | 405 |
| UZ-CLEO-160-06      | 334 | UZ-FLAVIO-128-06  | 342 | UZ-G1-192-05    | 346 | UZ-MARSA-64-07    | 395 |
| UZ-CLEO-192-01      | 334 | UZ-FLAVIO-128-16  | 342 | UZ-G1-192-06    | 346 | UZ-MARSA-64-09    | 395 |
| UZ-CLEO-192-05      | 334 | UZ-FLAVIO-128-20M | 342 | UZ-G1-192-13    | 346 | UZ-MARSA-64-10M   | 395 |
| UZ-CLEO-192-06      | 334 | UZ-FLAVIO-160-01  | 342 | UZ-G1-192-20M   | 346 | UZ-MARSA-64-11    | 395 |
| UZ-COM0096-01       | 404 | UZ-FLAVIO-160-06  | 342 | UZ-G1-256-01    | 346 | UZ-MARSA-64-15    | 395 |
| UZ-COM0128-01       | 404 | UZ-FLAVIO-160-16  | 342 | UZ-G1-256-05    | 346 | UZ-MARSA-64-18    | 395 |
| UZ-COM0160-01       | 404 | UZ-FLAVIO-160-20M | 342 | UZ-G1-256-06    | 346 | UZ-MARSA-64-20M   | 395 |
| UZ-CRA14-128        | 403 | UZ-FLOW-128-06    | 354 | UZ-G1-256-13    | 346 | UZ-MILAN-128-01   | 329 |
| UZ-CRA14-192        | 403 | UZ-FLOW-128-20M   | 354 | UZ-G1-256-20M   | 346 | UZ-MILAN-128-05   | 329 |
| UZ-CRA14-320        | 403 | UZ-FLOW-128-90    | 354 | UZ-G1-320-01    | 346 | UZ-MILAN-128-06   | 329 |
| UZ-E6-096-01        | 367 | UZ-FLOW-192-06    | 354 | UZ-G1-320-05    | 346 | UZ-MILAN-128-20M  | 329 |
| UZ-E6-096-05        | 367 | UZ-FLOW-192-20M   | 354 | UZ-G1-320-06    | 346 | UZ-MILAN-256-01   | 329 |
| UZ-E6-096-06        | 367 | UZ-FLOW-192-90    | 354 | UZ-G1-320-13    | 346 | UZ-MILAN-256-05   | 329 |
| UZ-E6-128-01        | 367 | UZ-G0-128-01      | 346 | UZ-G1-320-20M   | 346 | UZ-MILAN-256-06   | 329 |
| UZ-E6-128-05        | 367 | UZ-G0-128-05      | 346 | UZ-G1-416-01    | 346 | UZ-MILAN-256-20M  | 329 |
| UZ-E6-128-06        | 367 | UZ-G0-128-06      | 346 | UZ-G1-416-05    | 346 | UZ-MODEN-128-01   | 327 |
| UZ-E6-160-01        | 367 | UZ-G0-160-01      | 346 | UZ-G1-416-06    | 346 | UZ-MODEN-128-05   | 327 |
| UZ-E6-160-05        | 367 | UZ-G0-160-05      | 346 | UZ-G2-160-01    | 322 | UZ-MODEN-128-06   | 327 |
| UZ-E6-160-06        | 367 | UZ-G0-160-06      | 346 | UZ-G2-160-06    | 322 | UZ-MODEN-128-20M  | 327 |
| UZ-EVER-128-20M     | 351 | UZ-G0-192-01      | 346 | UZ-G2-160-20M   | 322 | UZ-MODEN-160-01   | 327 |
| UZ-EVER-128-90      | 351 | UZ-G0-192-05      | 346 | UZ-G2-224-01    | 322 | UZ-MODEN-160-05   | 327 |
| UZ-FABRICIO-128-18  | 349 | UZ-G0-192-06      | 346 | UZ-G2-224-06    | 322 | UZ-MODEN-160-06   | 327 |
| UZ-FABRICIO-128-20M | 349 | UZ-G0-256-01      | 346 | UZ-G2-224-20M   | 322 | UZ-MODEN-160-20M  | 327 |
| UZ-FABRICIO-192-18  | 349 | UZ-G0-256-05      | 346 | UZ-GENUA128-01  | 345 | UZ-MODEN-192-01   | 327 |
| UZ-FABRICIO-192-20M | 349 | UZ-G0-256-06      | 346 | UZ-GENUA128-02  | 345 | UZ-MODEN-192-05   | 327 |
| UZ-FABRICIO-320-18  | 349 | UZ-G1-128-01      | 346 | UZ-GENUA128-05  | 345 | UZ-MODEN-192-06   | 327 |
| UZ-FABRICIO-320-20M | 349 | UZ-G1-128-05      | 346 | UZ-GENUA128-20M | 345 | UZ-MODEN-192-20M  | 327 |
| UZ-FIORD-32-05      | 375 | UZ-G1-128-06      | 346 | UZ-GENUA160-01  | 345 | UZ-MONA-128-01-10 | 320 |
| UZ-FIORD-32-06      | 375 | UZ-G1-128-13      | 346 | UZ-GENUA160-02  | 345 | UZ-MONA-128-01-20 | 320 |
| UZ-FIORD-32-18      | 375 | UZ-G1-128-20M     | 346 | UZ-GENUA160-05  | 345 | UZ-MONA-192-01-10 | 320 |

|                    |     |                     |     |                   |     |                  |     |
|--------------------|-----|---------------------|-----|-------------------|-----|------------------|-----|
| UZ-MONA-192-01-20  | 320 | UZ-OCTAVIO-192-20M  | 330 | UZ-TH096128-06    | 342 | UZ-Z10128-20M    | 359 |
| UZ-MONA-256-01-10  | 320 | UZ-OLBIA-96-04      | 394 | UZ-TH160192-01    | 342 | <b>W</b>         |     |
| UZ-MONA-256-01-20  | 320 | UZ-OLBIA-128-04     | 394 | UZ-TH160192-05    | 342 | WA-MALAG-A0-01   | 420 |
| UZ-MONZA16-10      | 318 | UZ-OTTO-128-06      | 350 | UZ-TH160192-06    | 342 | WA-MALAG-A0-02   | 420 |
| UZ-MONZA160-06     | 318 | UZ-OTTO-128-20M     | 350 | UZ-TH288320-01    | 342 | WA-MALAG-A0-05   | 420 |
| UZ-MONZA160-10     | 318 | UZ-OTTO-128-90      | 350 | UZ-TH288320-06    | 342 | WA-MALAG-A0-20   | 420 |
| UZ-MONZA160-20     | 318 | UZ-OTTO-160-06      | 350 | UZ-TIVOL-192-01   | 322 | WA-MALAG-B0-01   | 421 |
| UZ-MONZA256-06     | 318 | UZ-OTTO-160-20M     | 350 | UZ-TIVOL-192-12   | 322 | WA-MALAG-B0-02   | 421 |
| UZ-MONZA256-10     | 318 | UZ-OTTO-160-90      | 350 | UZ-TIVOL-192-13   | 322 | WA-MALAG-B0-05   | 421 |
| UZ-MONZA256-20     | 318 | UZ-PALER-96-07      | 388 | UZ-TIVOL-320-01   | 322 | WA-MALAG-B0-20   | 421 |
| UZ-MONZA384-06     | 318 | UZ-PALER-128-07     | 388 | UZ-TIVOL-320-12   | 322 | WB-073024-01     | 217 |
| UZ-MONZA384-10     | 318 | UZ-PRATO-160-01     | 336 | UZ-TIVOL-320-13   | 322 | WB-073024-06     | 217 |
| UZ-MONZA384-20     | 318 | UZ-PRATO-160-06     | 336 | UZ-VASTO-96-09    | 388 | WB-073025-01     | 218 |
| UZ-NORD-128-03     | 347 | UZ-PRATO-320-01     | 336 | UZ-VASTO-128-09   | 388 | WB-073025-06     | 218 |
| UZ-NORD-128-18     | 347 | UZ-PRATO-320-06     | 336 | UZ-VENICE-128-20M | 348 | WB-073026-01     | 218 |
| UZ-NORD-128-20M    | 347 | UZ-REN096-04A       | 399 | UZ-VENICE-128-90  | 348 | WB-073026-06     | 218 |
| UZ-NORD-160-03     | 347 | UZ-RETRIS-128-04    | 390 | UZ-VITO-160-01    | 340 | WB-WS-12-010     | 219 |
| UZ-NORD-160-18     | 347 | UZ-RETRIS-128-07    | 390 | UZ-VITO-160-05    | 340 | WB-WS-18-010     | 219 |
| UZ-NORD-160-20M    | 347 | UZ-RETRIS-128-20M   | 390 | UZ-VITO-160-07    | 340 | WB-WS-18-020     | 219 |
| UZ-NORD-192-03     | 347 | UZ-ROYAL1-96-10-03  | 396 | UZ-VITO-160-12    | 340 | WB-WS-18-060     | 219 |
| UZ-NORD-192-18     | 347 | UZ-ROYAL2-96-10-03  | 396 | UZ-VITO-160-16    | 340 | WB-WS-24-010     | 220 |
| UZ-NORD-192-20M    | 347 | UZ-ROYAL3-96-10-03  | 396 | UZ-VITO-160-20M   | 340 | WB-WS-24-020     | 220 |
| UZ-NORD-320-03     | 347 | UZ-ROYAL4-96-03     | 396 | UZ-VITO-288-01    | 340 | W-CUSTOMI-60L450 | 200 |
| UZ-NORD-320-18     | 347 | UZ-ROYAL5-96-10-03  | 396 | UZ-VITO-288-05    | 340 | W-CUSTOMI-60L500 | 200 |
| UZ-NORD-320-20M    | 347 | UZ-ROYAL5-128-10-03 | 396 | UZ-VITO-288-07    | 340 | W-CUSTOMI-80L450 | 201 |
| UZ-OCTAVIO-128-01  | 330 | UZ-SIENNA096-01     | 404 | UZ-VITO-288-12    | 340 | W-CUSTOMI-80L500 | 201 |
| UZ-OCTAVIO-128-06  | 330 | UZ-SIENNA128-01     | 404 | UZ-VITO-288-16    | 340 | WG-KOSZ60-10     | 253 |
| UZ-OCTAVIO-128-18  | 330 | UZ-SIENNA160-01     | 404 | UZ-VITO-288-20M   | 340 | WG-KOSZ60-60     | 253 |
| UZ-OCTAVIO-128-20M | 330 | UZ-STEP-160-07      | 353 | UZ-WERON-96-04    | 391 | WG-KOSZ70-10     | 253 |
| UZ-OCTAVIO-160-01  | 330 | UZ-STEP-160-20M     | 353 | UZ-WERON-96-09    | 391 | WG-KOSZ70-60     | 253 |
| UZ-OCTAVIO-160-06  | 330 | UZ-STILO-128-18     | 355 | UZ-WERON-96-12    | 391 | WG-KOSZ80-10     | 253 |
| UZ-OCTAVIO-160-18  | 330 | UZ-STILO-128-20M    | 355 | UZ-WERON-128-04   | 391 | WG-KOSZ80-60     | 253 |
| UZ-OCTAVIO-160-20M | 330 | UZ-STILO-160-18     | 355 | UZ-WERON-128-09   | 391 | WG-KOSZ90-10     | 253 |
| UZ-OCTAVIO-192-01  | 330 | UZ-STILO-160-20M    | 355 | UZ-WERON-128-12   | 391 | WG-KOSZ90-60     | 253 |
| UZ-OCTAVIO-192-06  | 330 | UZ-TH096128-01      | 342 | UZ-WP1146-04      | 397 | WG-KOSZM60-10    | 252 |
| UZ-OCTAVIO-192-18  | 330 | UZ-TH096128-05      | 342 | UZ-Z10096-01      | 359 | WG-KOSZM60-60    | 252 |
|                    |     |                     |     | UZ-Z10096-02      | 359 | WG-KOSZM70-10    | 252 |
|                    |     |                     |     | UZ-Z10096-05      | 359 | WG-KOSZM70-60    | 252 |
|                    |     |                     |     | UZ-Z10096-20M     | 359 | WG-KOSZM80-10    | 252 |
|                    |     |                     |     | UZ-Z10128-01      | 359 | WG-KOSZM80-60    | 252 |
|                    |     |                     |     | UZ-Z10128-02      | 359 | WG-KOSZM90-10    | 252 |
|                    |     |                     |     | UZ-Z10128-05      | 359 | WG-KOSZM90-60    | 252 |
|                    |     |                     |     |                   | 359 | WG-KOSZR60-10    | 254 |
|                    |     |                     |     |                   | 359 | WG-KOSZR60-60    | 254 |

|                |     |                         |     |                |     |              |     |
|----------------|-----|-------------------------|-----|----------------|-----|--------------|-----|
| WG-KOSZR70-10  | 254 | WG-WSP0D80-10           | 258 | WM-CLOUD-SZ    | 429 | WW-WSL000-01 | 270 |
| WG-KOSZR70-60  | 254 | WG-WSP0D80-60           | 258 | WM-STAR-NB     | 429 | WW-WSP000-01 | 270 |
| WG-KOSZR80-10  | 254 | WG-WSP0D90              | 258 | WM-STAR-RZ     | 429 | WW-WSP000-01 | 270 |
| WG-KOSZR80-60  | 254 | WG-WSP0D90-10           | 258 | WM-STAR-ZT     | 429 | WW-WUBR00-01 | 271 |
| WG-KOSZR90-10  | 254 | WG-WSP0D90-60           | 258 | WM-UNICORN-RZ  | 429 | WW-ZWBUT2-10 | 273 |
| WG-KOSZR90-60  | 254 | WK-CAM-15-12-D          | 230 | W-WKO60-BP-10  | 267 | WW-ZWBUT2-20 | 273 |
| WG-POBUW60-10  | 255 | WK-CAM-15-13-D          | 230 | W-WKO60-BP-60  | 266 | WZ-00-K24-04 | 428 |
| WG-POBUW60-60  | 255 | WK-CAM-15-DOW63X31-KPL- |     | W-WKO70-BP-10  | 267 | WZ-804-20-01 | 411 |
| WG-POBUW70-10  | 255 | -1T                     | 231 | W-WKO70-BP-60  | 266 | WZ-804-20-05 | 411 |
| WG-POBUW70-60  | 255 | WK-CAM-15-DOW63X35-KPL- |     | W-WKO80-BP-10  | 267 | WZ-804-20-06 | 411 |
| WG-POBUW80-10  | 255 | -1T                     | 231 | W-WKO80-BP-60  | 266 | WZ-A0-K23-01 | 416 |
| WG-POBUW80-60  | 255 | WK-CAM-15-DOW63X39-KPL- |     | W-WKO90-BP-10  | 267 | WZ-A0-K23-02 | 416 |
| WG-POBUW90-10  | 255 | -1T                     | 231 | W-WKO90-BP-60  | 266 | WZ-A0-K23-03 | 416 |
| WG-POBUW90-60  | 255 | WK-CAM-15-DOW63X45-KPL- |     | W-WKRP-BP-10   | 268 | WZ-A0-K23-04 | 416 |
| WG-POBUWM60-10 | 256 | -1T                     | 231 | W-WKRP-BP-60   | 268 | WZ-A0-K23-05 | 416 |
| WG-POBUWM60-60 | 256 | WK-CF0750-01            | 231 | W-WKRP-VE-10   | 268 | WZ-A0-K23-06 | 416 |
| WG-POBUWM70-10 | 256 | WK-CF6450-01            | 231 | W-WKRP-VE-60   | 268 | WZ-A0-K23-07 | 416 |
| WG-POBUWM70-60 | 256 | WK-D0320-001*           | 229 | W-W0BU60-BP-10 | 263 | WZ-A0-K23-20 | 416 |
| WG-POBUWM80-10 | 256 | WK-D0325-001*           | 229 | W-W0BU60-BP-60 | 262 | WZ-A0-K24-01 | 418 |
| WG-POBUWM80-60 | 256 | WK-D0330-001*           | 229 | W-W0BU70-BP-10 | 263 | WZ-A0-K24-02 | 418 |
| WG-POBUWM90-10 | 256 | WK-D0416-001            | 229 | W-W0BU70-BP-60 | 262 | WZ-A0-K24-03 | 418 |
| WG-POBUWM90-60 | 256 | WK-D0425-001*           | 229 | W-W0BU80-BP-10 | 263 | WZ-A0-K24-04 | 418 |
| WG-PRZEG60-10  | 257 | WK-D0430-001            | 229 | W-W0BU80-BP-60 | 262 | WZ-A0-K24-05 | 418 |
| WG-PRZEG60-60  | 257 | WK-D0440-001            | 229 | W-W0BU90-BP-10 | 263 | WZ-A0-K24-07 | 418 |
| WG-PRZEG70-10  | 257 | WK-D0460-001            | 229 | W-W0BU90-BP-60 | 262 | WZ-A0-K24-20 | 418 |
| WG-PRZEG70-60  | 257 | WK-D3516-001            | 229 | W-WSPD60-BP-10 | 265 | WZ-B0-K23-01 | 416 |
| WG-PRZEG80-10  | 257 | WK-D3530-001            | 229 | W-WSPD60-BP-60 | 264 | WZ-B0-K23-02 | 416 |
| WG-PRZEG80-60  | 257 | WK-DOW63X31G-D          | 230 | W-WSPD70-BP-10 | 265 | WZ-B0-K23-03 | 416 |
| WG-PRZEG90-10  | 257 | WK-DOW63X35B-D          | 230 | W-WSPD70-BP-60 | 264 | WZ-B0-K23-04 | 416 |
| WG-PRZEG90-60  | 257 | WK-DOW63X39-D           | 230 | W-WSPD80-BP-10 | 265 | WZ-B0-K23-05 | 416 |
| WG-RDR0-10     | 259 | WK-DOW63X45B-D          | 230 | W-WSPD80-BP-60 | 264 | WZ-B0-K23-06 | 416 |
| WG-RDR0-60     | 259 | WK-SZ-AS-400-10         | 202 | W-WSPD90-BP-10 | 265 | WZ-B0-K23-07 | 416 |
| WG-RDRP-10     | 259 | WK-SZ-AS-400-60         | 202 | W-WSPD90-BP-60 | 264 | WZ-B0-K23-20 | 416 |
| WG-RDRP-60     | 259 | WK-SZ-AS-500-10         | 202 | WW-WSD250-01B  | 272 | WZ-B0-K24-01 | 418 |
| WG-RRPSET-A-10 | 259 | WK-SZ-AS-500-60         | 202 | WW-WSD300-01B  | 272 | WZ-B0-K24-02 | 418 |
| WG-RRPSET-A-60 | 259 | WK-SZ-AS-600-10         | 202 | WW-WSD350-01B  | 272 | WZ-B0-K24-03 | 418 |
| WG-RRPSET-B-10 | 259 | WK-SZ-AS-600-60         | 202 | WW-WSD400-01B  | 272 | WZ-B0-K24-04 | 418 |
| WG-RRPSET-B-60 | 259 | WK-SZ-AS-800-10         | 202 | WW-WSD450-01B  | 272 | WZ-B0-K24-05 | 418 |
| WG-WSP0D60     | 258 | WK-SZ-AS-800-60         | 202 | WW-WSD500-01B  | 272 | WZ-B0-K24-07 | 418 |
| WG-WSP0D60-10  | 258 | WK-SZ-AS-900-10         | 202 | WW-WSL250-01   | 271 | WZ-B0-K24-20 | 418 |
| WG-WSP0D60-60  | 258 | WK-SZ-AS-900-60         | 202 | WW-WSL300-01   | 271 | WZ-C0-K24-01 | 420 |
| WG-WSP0D70     | 258 | WM-BALL-CZ-B            | 429 | WW-WSL350-01   | 271 | WZ-C0-K24-02 | 420 |
| WG-WSP0D70-10  | 258 | WM-BLOCK-NB             | 429 | WW-WSL400-01   | 271 | WZ-C0-K24-03 | 420 |
| WG-WSP0D70-60  | 258 | WM-BLOCK-ZL             | 429 | WW-WSL450-01   | 271 | WZ-C0-K24-04 | 420 |
| WG-WSP0D80     | 258 | WM-CLOUD-NB             | 429 | WW-WSL500-01   | 271 | WZ-C0-K24-05 | 420 |

|                 |     |                      |     |                    |     |                  |    |
|-----------------|-----|----------------------|-----|--------------------|-----|------------------|----|
| WZ-C0-K24-20    | 420 | WZ-ORVIE-B0-09       | 427 | ZM-ECHC08-3DBEO    | 73  | ZP-BIDI07-3DBEO  | 82 |
| WZ-CAPITAL-18   | 425 | WZ-SCTYLPR-BWK       | 224 | ZM-ECHC08BEO       | 70  | ZP-BIDI08-3DBEO  | 82 |
| WZ-CAPITAL-20M  | 425 | WZ-SCTYLPR-WK        | 224 | ZM-ECHC08H04-BE    | 71  | ZP-BIDI09-3DBEO  | 81 |
| WZ-CORDOBA-01   | 414 | WZ-TOLED-A0-01       | 412 | ZM-ECHC08ZEO       | 70  | ZP-CIBI7H0ZE     | 95 |
| WZ-CORDOBA-06   | 414 | WZ-TOLED-A0-02       | 412 | ZM-ECHC09-3DBEO    | 72  | ZP-CIBI8H0ZE     | 95 |
| WZ-CORDOBA-20M  | 414 | WZ-TOLED-A0-05       | 412 | ZM-ECHC09BEO       | 69  | ZP-CIBI9H0ZE     | 94 |
| WZ-CORUNA-D-04  | 422 | WZ-TOLED-A0-06       | 412 | ZM-ECHC09H04-BE    | 71  | ZP-CIG-070ZE     | 96 |
| WZ-CORUNA-D-07  | 422 | WZ-TOLED-A0-20M      | 412 | ZM-ECHC09ZEO       | 69  | ZP-CIG-07UZE     | 96 |
| WZ-CORUNA-D-17  | 422 | WZ-TOLED-B0-01       | 412 | ZM-HCKT30-BE-S     | 77  | ZP-CIG-090ZE     | 96 |
| WZ-CORUNA-D-20M | 422 | WZ-TOLED-B0-02       | 412 | ZM-HCKT30-ZE-S     | 77  | ZP-CIG-09UBE     | 96 |
| WZ-CORUNA-M-04  | 423 | WZ-TOLED-B0-05       | 412 | ZM-HCKT45-3DBEO-S  | 78  | ZP-CIG-09UZC     | 96 |
| WZ-CORUNA-M-07  | 423 | WZ-TOLED-B0-06       | 412 | ZM-HCKT45-BE-S     | 77  | ZP-CIG-09UZE     | 96 |
| WZ-CORUNA-M-17  | 423 | WZ-TOLED-B0-20M      | 412 | ZM-HCKT45-ZE-S     | 77  | ZP-CIG-170ZE     | 96 |
| WZ-CORUNA-M-20M | 423 | WZ-TOLED-C0-01       | 413 | ZM-HCKT90-3DBEO-S  | 79  | ZP-CIG-17UZE     | 96 |
| WZ-CRAFT-04     | 426 | WZ-TOLED-C0-02       | 413 | ZM-HCKT90-BE-S     | 78  | ZP-CIG-190ZE     | 96 |
| WZ-CRAFT-07     | 426 | WZ-TOLED-C0-05       | 413 | ZM-HCKT90-ZE-S     | 78  | ZP-CIG-19UZE     | 96 |
| WZ-CRAFT-15     | 426 | WZ-TOLED-C0-06       | 413 | ZM-HCKT155BE       | 80  | ZP-CIHC070ZE     | 94 |
| WZ-CRAFT-20M    | 426 | WZ-TOLED-C0-20M      | 413 | ZM-HCKT155ZE       | 80  | ZP-CIHC080ZE     | 93 |
| WZ-E-018-01     | 422 | WZ-WALENCIA-01       | 414 | ZM-HCKT165-3DBEO-S | 81  | ZP-CIHC090ZE     | 93 |
| WZ-E-018-02     | 422 | WZ-WALENCIA-06       | 414 | ZM-HCKT165BE-S     | 80  | ZP-COCA450-BE    | 89 |
| WZ-E-018-05     | 422 | WZ-WALENCIA-20M      | 414 | ZM-HCKT165ZE-S     | 80  | ZP-COCA450-BE-F  | 90 |
| WZ-E-018-06     | 422 |                      |     | ZM-HCKTK90-ZE      | 79  | ZP-COCA450-ZE    | 89 |
| WZ-E-018-20M    | 422 | <b>Z</b>             |     | ZM-HCRALU9BE       | 97  | ZP-COCA7450-BE   | 90 |
| WZ-K23-D1-01    | 417 | ZC-GTV-12-00         | 100 | ZM-INHC070BEO      | 76  | ZP-COCA7450-BE-F | 91 |
| WZ-K23-D1-02    | 417 | ZC-GTV-14-00         | 100 | ZM-INHC070ZEO      | 76  | ZP-COCA8450-BE   | 89 |
| WZ-K23-D1-05    | 417 | ZK-FORCE-KPL         | 225 | ZM-INHC080BEO      | 76  | ZP-COCA8450-BE-F | 91 |
| WZ-K23-D1-06    | 417 | ZK-FORZA-ZAS-KPL-010 | 227 | ZM-INHC080ZEO      | 76  | ZP-CONL07-BE     | 84 |
| WZ-K23-E1-01    | 417 | ZK-FORZA-ZAS-KPL-020 | 227 | ZM-INHC090BEO      | 75  | ZP-CONL07-ZE     | 84 |
| WZ-K23-E1-05    | 417 | ZK-FORZA-ZAW-KPL     | 226 | ZM-INHC090ZEO      | 75  | ZP-CONL08-BE     | 83 |
| WZ-K23-E1-06    | 417 | ZK-R1-KPL-10         | 226 | ZM-KT45H2-BE       | 86  | ZP-CONL08-ZE     | 83 |
| WZ-K2201-01     | 415 | ZK-ZAW-R0-10         | 225 | ZM-OT-Standard     | 67  | ZP-CONL09-BE     | 83 |
| WZ-K2201-06     | 415 | ZK-ZAW-R0-30         | 225 | ZM-SZABLON-ZAW     | 101 | ZP-CONL09-ZE     | 83 |
| WZ-K2201-CZ     | 415 | ZM-CNHC07BR2         | 75  | ZN-OT-heavy        | 67  | ZP-JUNIOR-00     | 99 |
| WZ-K2202-01     | 415 | ZM-CNHC08BR2         | 74  | ZP-BICN070BEO      | 85  | ZP-KT30H2-BE     | 86 |
| WZ-K2202-06     | 415 | ZM-CNHC09BR2         | 74  | ZP-BICN070ZEO      | 85  | ZP-KT45H2-ZE     | 86 |
| WZ-K2202-CZ     | 415 | ZM-DCHC07-3DBEO      | 68  | ZP-BICN072BEO      | 85  | ZP-KT90H2-BE     | 87 |
| WZ-MADRYT-04    | 424 | ZM-DCHC07-3DZEO      | 68  | ZP-BICN072ZEO      | 85  | ZP-KT90H2-ZE     | 87 |
| WZ-MADRYT-07    | 424 | ZM-DCHC08-3DBEO      | 68  | ZP-BICN080BEO      | 85  | ZP-KT135H2BE     | 88 |
| WZ-MADRYT-15    | 424 | ZM-DCHC08-3DZEO      | 68  | ZP-BICN080ZEO      | 85  | ZP-KT135H2ZE     | 88 |
| WZ-MADRYT-20M   | 424 | ZM-DCHC09-3DBEO      | 67  | ZP-BICN082BEO      | 85  | ZP-KT165H2BE     | 88 |
| WZ-MALAG-C0-01  | 421 | ZM-DCHC09-3DZEO      | 67  | ZP-BICN082ZEO      | 85  | ZP-KT165H2ZE     | 88 |
| WZ-MALAG-C0-02  | 421 | ZM-ECHC07-3DBEO      | 73  | ZP-BICN090BEO      | 84  | ZP-KT0270-BE     | 98 |
| WZ-MALAG-C0-05  | 421 | ZM-ECHC07BEO         | 70  | ZP-BICN090ZEO      | 84  | ZP-KTK90H6BE     | 87 |
| WZ-MALAG-C0-20  | 421 | ZM-ECHC07H04-BE      | 72  | ZP-BICN092BEO      | 84  | ZP-KTK90H6ZE     | 87 |
| WZ-ORVIE-A0-09  | 427 | ZM-ECHC07ZEO         | 70  | ZP-BICN092ZEO      | 84  | ZP-P07H045BE     | 92 |

|                |        |                |     |                |          |                |     |
|----------------|--------|----------------|-----|----------------|----------|----------------|-----|
| ZP-POH045BEO   | 92     | ZZ-30-103-01-S | 307 | ZZ-C8-288-01-S | 310      | ZZ-SP-KLMASTER | 310 |
| ZP-POH045ZEO   | 92     | ZZ-B0-105-01-S | 306 | ZZ-CF-138-01   | 305      | ZZ-SZ-409-01-S | 307 |
| ZP-RALUH2-00   | 97     | ZZ-BA-SK0-01-S | 309 | ZZ-G0-328-01   | 309      |                |     |
| ZP-SKR-00-80   | 100    | ZZ-BA-SK0-PR   | 309 | ZZ-KLMASTER    | 305      | ZZ-Z0-202-01-S | 308 |
| ZT-HF-01-D00   | 98, 99 | ZZ-C1-288-01-S | 310 | ZZ-KM-138-01-S | 304      | ZZ-ZN-138-01   | 304 |
| ZZ-16-103-01-S | 307    | ZZ-C5-288-01-S | 310 | ZZ-M0-201-01-S | 308      |                |     |
| ZZ-20-103-01-S | 307    | ZZ-C6-288-01-S | 310 | ZZ-SP-105-05   | 310, 515 | ZZ-ZN-338-01-S | 306 |



Niniejszy katalog produktów został przygotowany przez GTV Poland. Poprzez ciągłe udoskonalanie swojej oferty, zgodnie z wymogami rynkowymi i prawnymi, GTV Poland zastrzega sobie prawo do wprowadzania zmian w przedstawionym asortymencie. Prezentowana publikacja nie jest ofertą w rozumieniu Kodeksu Cywilnego. Rzeczywiste produkty mogą odbiegać od poglądowych zdjęć i rysunków zamieszczonych w publikacji. GTV Poland zastrzega sobie prawo do zmian i błędów w druku.

This product catalogue has been prepared by GTV Poland. Constantly improving its products so as to follow market and legal requirements, GTV Poland reserves the right to introduce changes in the presented product range. The present publication does not constitute an offer within the meaning of the Civil Code. The real products can differ from the example photographs and drawings in the publication. GTV Poland reserves the right to make changes and printing errors.

Данный каталог был создан компанией GTV Poland. В соответствии с действующим законодательством и требованиями рынка, компания GTV Poland оставляет за собой право вносить изменения в ассортимент предлагаемого товара. Данная публикация носит информационно-ознакомительный характер и не является коммерческим предложением в понимании права. Компания не несет ответственности за возможные цветовые расхождения, опечатки и неточности.



ul. Przejazdowa 21  
05-800 Pruszków  
Poland

 +48 22 44 47 272

 +48 22 44 47 366  
+48 22 44 47 331

 +48 22 44 47 391

 +48 22 44 47 379

 +420 591 160 091

 +48 22 444 73 24  
+48 22 444 73 07

 +375 291 504 626  
+48 22 44 47 523

 +48 22 44 47 524  
+48 735 201 464

 +48 22 4447 525

 +48 22 44 47 297  
+48 539 770 636

 тел: 8-495-640 15 88

 GTV Croatia d.o.o  
Kovinska 4a, 10000 Zagreb  
Hrvatska  
+ 385 1 798 8089

 GTV Czech Distribution s.r.o.  
CTPark Ostrava, Na Rovince 879  
720 00 Ostrava-Hrabová  
Česká republika  
+420 591 160 092  
+420 727 800 362  
+420 725 715 142

 GTV España Herrajes e Iluminación,  
S.L., Avenida Aragón 30, Planta 8  
46021 Valencia (España)  
+ 34 960 468 666  
+ 48 22 444 73 77

fax: +48 22 444 75 01

e-mail: [info@gtv.com.pl](mailto:info@gtv.com.pl)

[www.gtv.com.pl](http://www.gtv.com.pl)

Follow us on

