

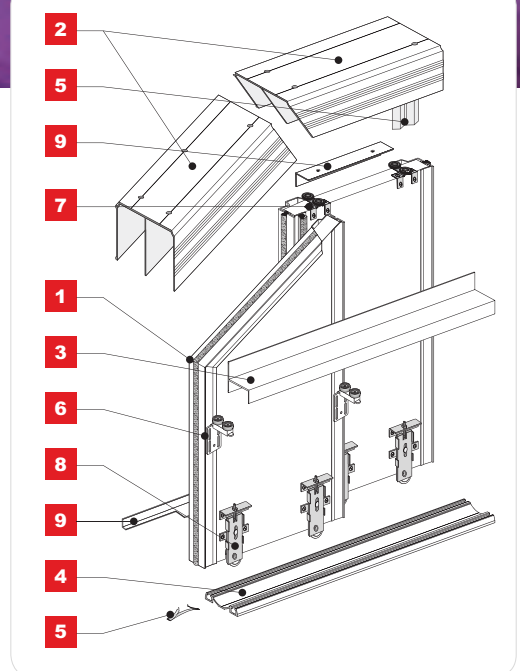

# GEMINI 18 EVEREST

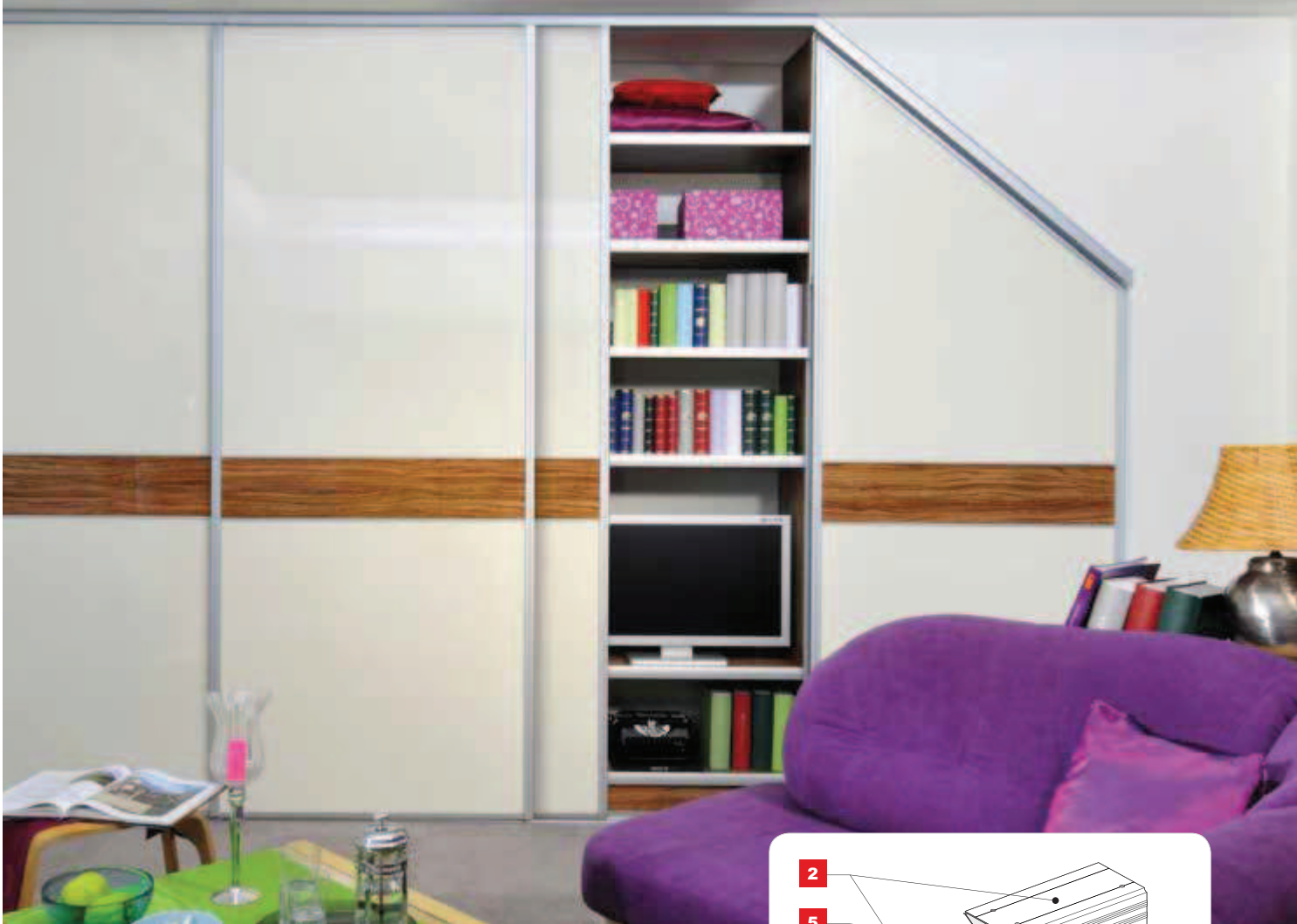

Twin track sliding angled doors with bottom carriage system



## CHARACTERISTICS

▶ Application	Sliding doors
▶ Track	Twin
▶ Carriage system	Bottom
▶ Top guide	Ball bearing carriage
▶ Bottom guide	Ball bearing carriage (load bearing)
▶ Construction	Board
▶ Filling	18 mm, 16 mm or 12 mm MFC + 4 mm mirror
▶ Max. door load	50 kg
▶ Max. handle length	2700 mm
▶ Max. track length	3000 mm
▶ Textile door stops	Yes
▶ Anti-dust brushes	Yes
▶ Sales programme	Components can be purchased separately
▶ Decorative profile programme	DECOR

## USAGE

- ▶ Built-in furniture, walk-in wardrobes, wardrobes, attics

Handle **UNIVERSAL 16 C**

1a



CODE	COLOUR	LENGTH (mm)	COLLECTIVE PACKAGING	PRICED PER	NET PRICE
04539	SILVER	2700	20	item	
04538	LIGHT BROWN	2700	20	item	

Handle **UNIVERSAL 18 C**

1b

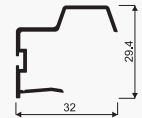

CODE	COLOUR	LENGTH (mm)	COLLECTIVE PACKAGING	PRICED PER	NET PRICE
04535	SILVER	2700	20	item	
04534	LIGHT BROWN	2700	20	item	

Top track **GEMINI-Decor****DECOR**

2

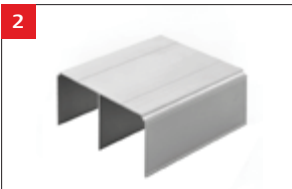

CODE	COLOUR	LENGTH (mm)	COLLECTIVE PACKAGING	PRICED PER	NET PRICE
01023	SILVER	1700	12	item	
01008	LIGHT BROWN	1700	12	item	
01025	SILVER	2350	12	item	
01010	LIGHT BROWN	2350	12	item	
01026	SILVER	3000	12	item	
01011	LIGHT BROWN	3000	12	item	
01469	SILVER	4050	12	item	
01439	LIGHT BROWN	4050	12	item	
01391	SILVER	6000	12	item	
01390	LIGHT BROWN	6000	12	item	

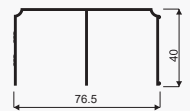
Track **EVEREST-Decor****DECOR**

3

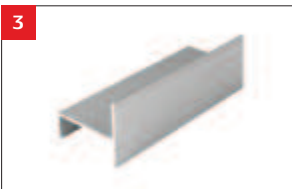

CODE	COLOUR	LENGTH (mm)	COLLECTIVE PACKAGING	PRICED PER	NET PRICE
02382	SILVER	3000	24	item	
02383	LIGHT BROWN	3000	24	item	

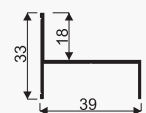

Bottom track **GEMINI-Decor****DECOR**

4a

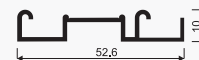

CODE	COLOUR	LENGTH (mm)	COLLECTIVE PACKAGING	PRICED PER	NET PRICE
00809	SILVER	1700	12	item	
00798	LIGHT BROWN	1700	12	item	
00811	SILVER	2350	12	item	
00800	LIGHT BROWN	2350	12	item	
00812	SILVER	3000	12	item	
00801	LIGHT BROWN	3000	12	item	
01474	SILVER	4050	12	item	
01478	LIGHT BROWN	4050	12	item	
02430	SILVER	6000	12	item	
02429	LIGHT BROWN	6000	12	item	

Bottom track **ELEGANT II-Decor****DECOR**

4b



CODE	COLOUR	LENGTH (mm)	COLLECTIVE PACKAGING	PRICED PER	NET PRICE
04279	SILVER	1700	12	item	
04273	LIGHT BROWN	1700	12	item	
04280	SILVER	2350	12	item	
04274	LIGHT BROWN	2350	12	item	
04281	SILVER	3000	12	item	
04275	LIGHT BROWN	3000	12	item	
04282	SILVER	4050	12	item	
04276	LIGHT BROWN	4050	12	item	
04284	SILVER	6000	12	item	
04278	LIGHT BROWN	6000	12	item	

Covering strip for bottom track **ELEGANT II****DECOR**

4b +



CODE	COLOUR	LENGTH (mm)	COLLECTIVE PACKAGING	PRICED PER	NET PRICE
04302	SILVER	1700	48	item	
04296	LIGHT BROWN	1700	48	item	
04303	SILVER	2350	48	item	
04297	LIGHT BROWN	2350	48	item	
04304	SILVER	3000	48	item	
04298	LIGHT BROWN	3000	48	item	
04305	SILVER	4050	48	item	
04299	LIGHT BROWN	4050	48	item	
04307	SILVER	6000	48	item	
04301	LIGHT BROWN	6000	48	item	

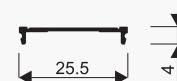

Top carriage positioner **FIX****i** Recommended screw: Unix 3x13 (code 20096)

5a



CODE	COLLECTIVE PACKAGING	PRICED PER	NET PRICE
20326	10	item	

Stopper for bottom carriage  
**HI-TEC**

5b



CODE	COLLECTIVE PACKAGING	PRICED PER	NET PRICE
20080	100	item	

**SET:** Guiding carriage  
**EVEREST****i** Set includes 2 carriages

6



CODE	COLLECTIVE PACKAGING	PRICED PER	NET PRICE
10089	50	set	

Guiding carriage **FOCUS****i** Set includes 2 carriages, fully packaged

7

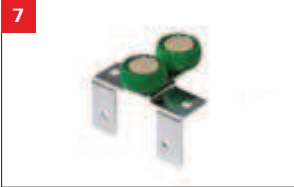

CODE	COLLECTIVE PACKAGING	PRICED PER	NET PRICE
10196	50	set	

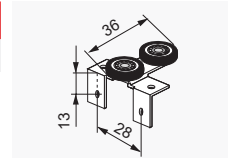
Bottom carriage  
**WD 18C HI-TEC****i** Set includes 2 carriages

8a



CODE	COLLECTIVE PACKAGING	PRICED PER	NET PRICE
10198	50	set	



## Bottom carriage

## WD 18V HI-TEC

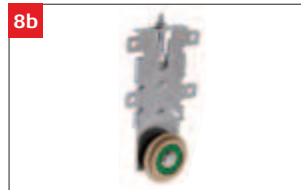

**i** Set includes 2 carriages and stopper HI-TEC

CODE	COLLECTIVE PACKAGING	PRICED PER	NET PRICE
10197	50	set	

## Angle section MINI 11x17

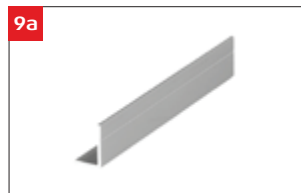

CODE	COLOUR	LENGTH (mm)	COLLECTIVE PACKAGING	PRICED PER	NET PRICE
00102	SILVER	1700	120	item	
00093	LIGHT BROWN	1700	120	item	
00103	SILVER	2350	120	item	
00094	LIGHT BROWN	2350	120	item	
00104	SILVER	3000	120	item	
00095	LIGHT BROWN	3000	120	item	

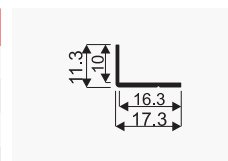

## Angle section ZW 20x18



CODE	COLOUR	LENGTH (mm)	COLLECTIVE PACKAGING	PRICED PER	NET PRICE
00058	SILVER	1700	60	item	
00052	LIGHT BROWN	1700	60	item	
00059	SILVER	2350	60	item	
00053	LIGHT BROWN	2350	60	item	
00060	SILVER	3000	60	item	
00054	LIGHT BROWN	3000	60	item	

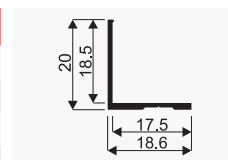

Angle section **K2-Decor****DECOR****9c**

CODE	COLOUR	LENGTH (mm)	COLLECTIVE PACKAGING	PRICED PER	NET PRICE
00078	SILVER	1700	60	item	
00069	LIGHT BROWN	1700	60	item	
00079	SILVER	2350	60	item	
00070	LIGHT BROWN	2350	60	item	
00080	SILVER	3000	60	item	
00071	LIGHT BROWN	3000	60	item	

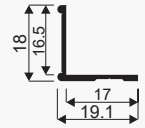
T-profile **04-Decor****DECOR**

CODE	COLOUR	LENGTH (mm)	COLLECTIVE PACKAGING	PRICED PER	NET PRICE
00691	SILVER	3000	60	item	
00688	LIGHT BROWN	3000	60	item	

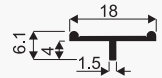
T-profile **18-Decor****DECOR**

CODE	COLOUR	LENGTH (mm)	COLLECTIVE PACKAGING	PRICED PER	NET PRICE
01373	SILVER	3000	60	item	
01370	LIGHT BROWN	3000	60	item	

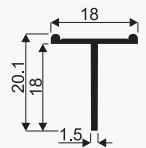

T-profile **ZW**

CODE	COLOUR	LENGTH (mm)	COLLECTIVE PACKAGING	PRICED PER	NET PRICE
00706	SILVER	3000	60	item	
00703	LIGHT BROWN	3000	60	item	

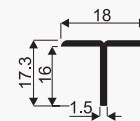
H-profile **H08/16**

CODE	COLOUR	LENGTH (mm)	COLLECTIVE PACKAGING	PRICED PER	NET PRICE
03935	SILVER	3000	60	item	
03934	LIGHT BROWN	3000	60	item	

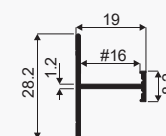
H-profile **H08/18**

CODE	COLOUR	LENGTH (mm)	COLLECTIVE PACKAGING	PRICED PER	NET PRICE
00199	SILVER	3000	60	item	
01877	LIGHT BROWN	3000	60	item	

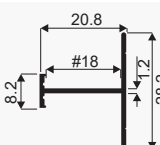
H-profile **H04/18**

CODE	COLOUR	LENGTH (mm)	COLLECTIVE PACKAGING	PRICED PER	NET PRICE
01710	SILVER	3000	60	item	
01711	LIGHT BROWN	3000	60	item	

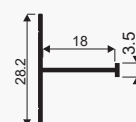

H-profile **H16-Decor****DECOR**

CODE	COLOUR	LENGTH (mm)	COLLECTIVE PACKAGING	PRICED PER	NET PRICE
03937	SILVER	3000	60	item	
03936	LIGHT BROWN	3000	60	item	

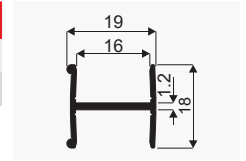
H-profile **H18-Decor****DECOR**

CODE	COLOUR	LENGTH (mm)	COLLECTIVE PACKAGING	PRICED PER	NET PRICE
00215	SILVER	3000	60	item	
00212	LIGHT BROWN	3000	60	item	
00216	GOLD	3000	60	item	

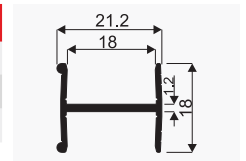
**TEXTILE DOOR STOP**

**i** Our full offer can be found in the "Profiles and furniture accessories" section

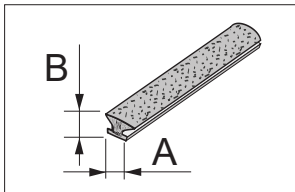

CODE	NAME	A (mm)	B (mm)	INSTALLATION	ROLL LENGTH	COLLECTIVE PACKAGING	PRICED PER
20020-SV	TEXTILE DOOR STOP	4.8	4	INSERTED	550 r.m.	4 rolls	running M
20225-SV	TEXTILE DOOR STOP	4.8	4	INSERTED	100 r.m.	10 rolls	roll
20143-SV	ANTI-DUST BRUSH	6.7	9	SELF-ADHESIVE	225 r.m.	4 rolls	running M

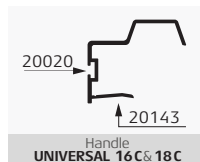
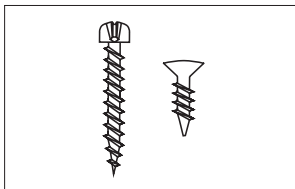
Screws **SMART, UNIX**

CODE	NAME	DIMENSIONS (mm)	PRICED PER	COLLECTIVE PACKAGING	NET PRICE
20041	SCREW SMART	2.5 x 18	100 pcs	100 packs	
20092	SCREW SMART	2.5 x 25	100 pcs	100 packs	
20107	COUNTERSUNK SCREW UNIX	3 x 13	100 pcs	20 packs	

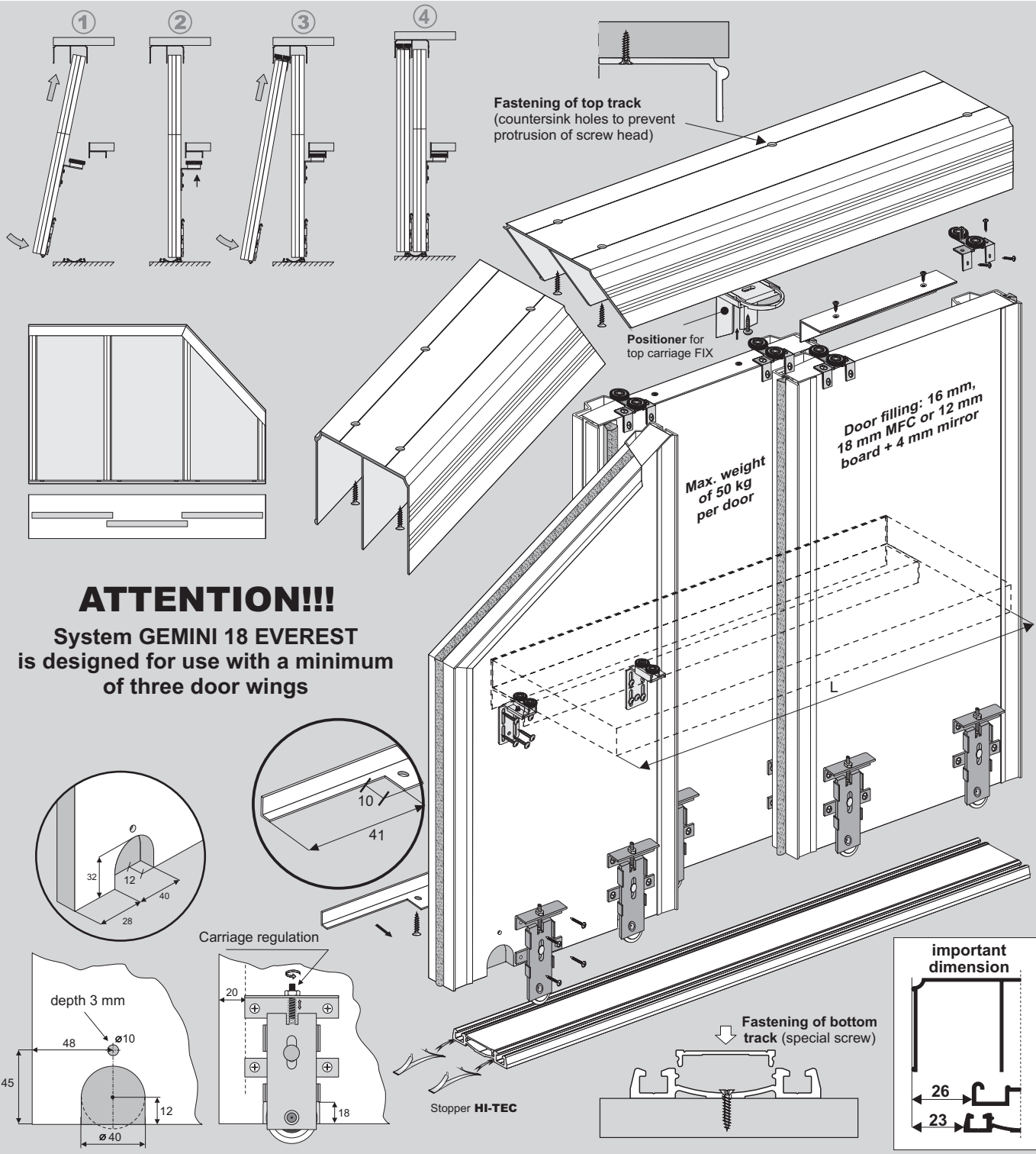

**COMPONENTS**

**Handle Universal C**

anti-dust brushes (self-adhesive) 6.7 mm x 9 mm

textile door stop (inserted) 4.8 mm x 4 mm #16 i #18

Length: 2.7 m

**Top track Gemini Decor**

76 mm

Length: 1.7 m, 2.35 m, 3.0 m, 4.05 m, 6.0 m

**Track Everest**

Length: 3.0 m

**Bottom track Elegant II (A)**  
**Covering strip Elegant II (B)**

Length: 1.7 m, 2.35 m, 3.0 m, 4.05 m, 6.0 m

**Angle section ZW**

20 mm x 18 mm

Length: 1.7 m, 2.35 m, 3.0 m

**Guiding track Focus WPFc-Duo**

**Bottom track WD18V HI-TEC**

**Guiding track Everest WPEv-Duo left / right**

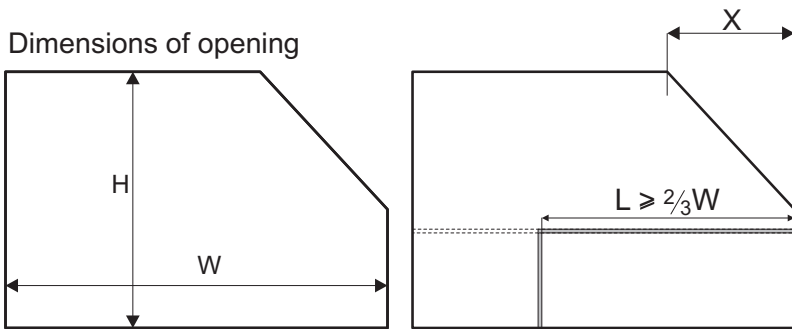

L - length of track Everest  
 $L_{min.} = \frac{2}{3}W$   
 $L_{max.} = W$   
 X - length of angle section  
 $w_a \geq X$   
 $w_a$  - width of the wing with angle section

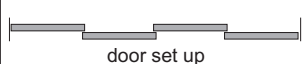
door height	- h	$h = H - 42 \text{ mm}$	
board height	- hb	$hb = h - 2 \text{ mm}$	
door width	- w	$w = (W - 3 \text{ mm} + Z) : N$	
board width	#12,#18 - wb	$wb = w - 7 \text{ mm}$	
angle section mini length	- la	$la = w - 62.4 \text{ mm}$	
number of doors	- N	3	4
total overlap	- Z	64 mm	96 mm
		visual design - 4 wings	
			

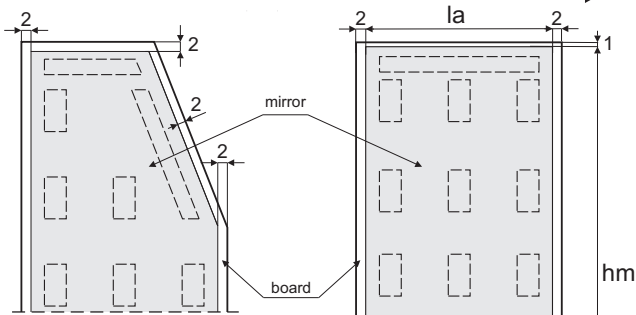
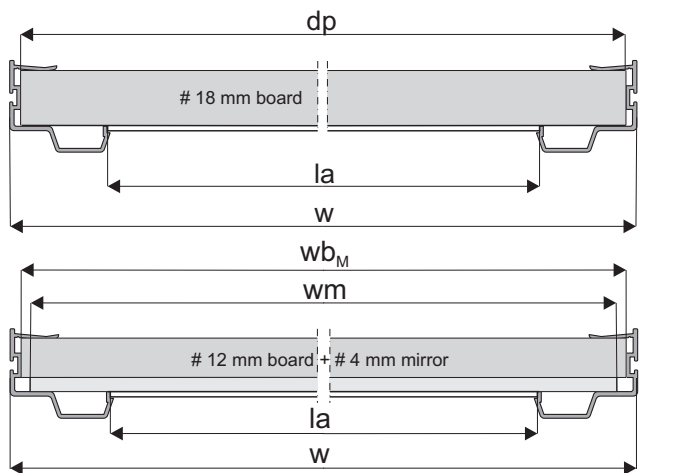
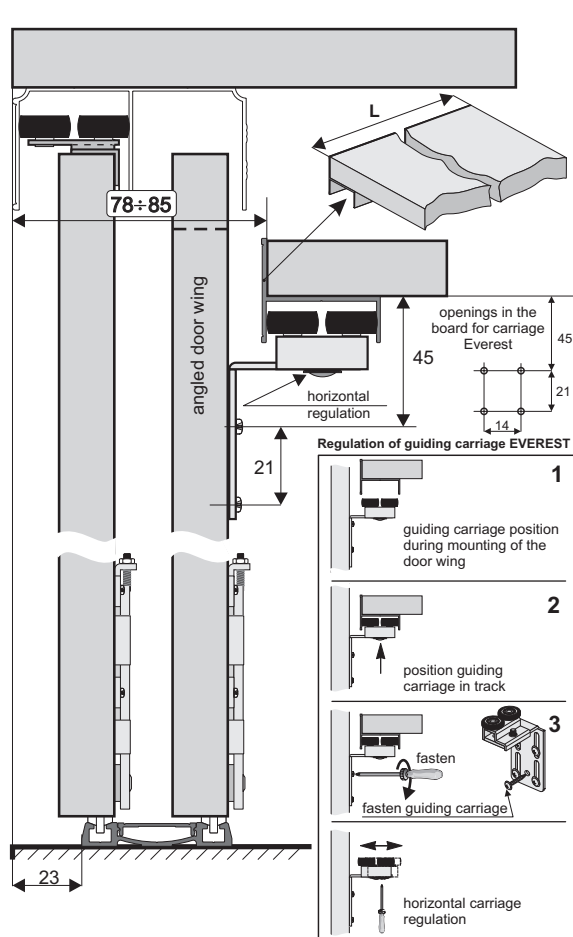

**mirror dimension**  
 mirror height -  $hm = hb - 4 \text{ mm}$   
 mirror width -  $wm = wb - 4 \text{ mm}$

**ATTENTION:**  
 Board to mirror contact area should be free from dirt and grease before applying double-sided tape.

Broken line indicates recommended positioning of double-sided tape

**Installation method for handle and guiding carriage with # 18 mm board (handle UNIVERSAL C # 18 mm)**

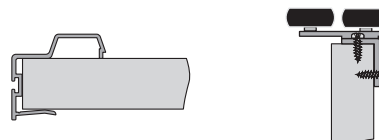

**Installation method for handle and guiding carriage with # 12 mm board and # 4 mm mirror (handle UNIVERSAL C # 16 mm)**

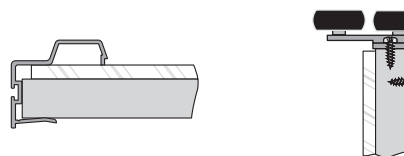

**Installation method for angle-section 20 mm x 18 mm**

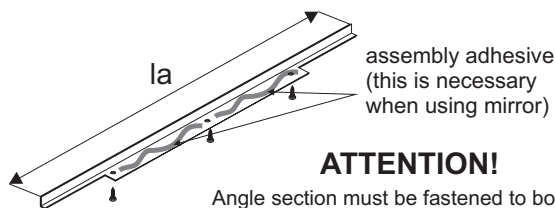
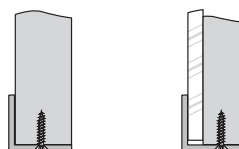

**ATTENTION!**  
 Angle section must be fastened to board with a minimum of 3 screws  $\varnothing 3 \times 25$ .

**ATTENTION!** Remove protective film from aluminium elements (handles, tracks, connectors, etc.) prior to cutting them to the desired size. Film removal will reveal quality issues (eg. scratches)