



# GEMINI 4



Twin track sliding doors with bottom carriage system

NEW!

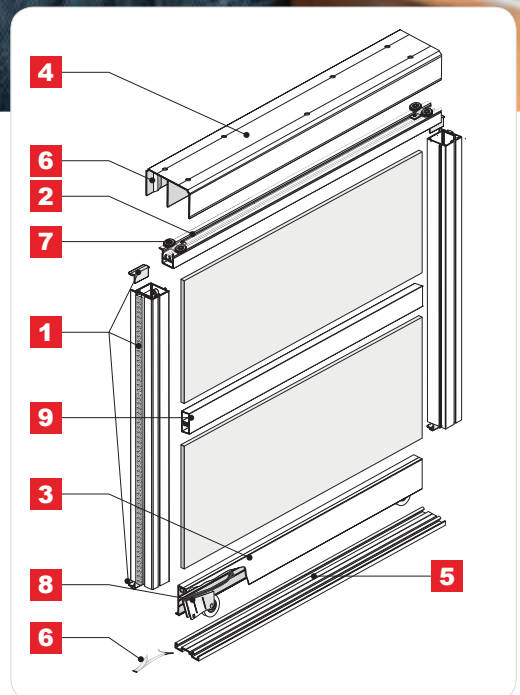
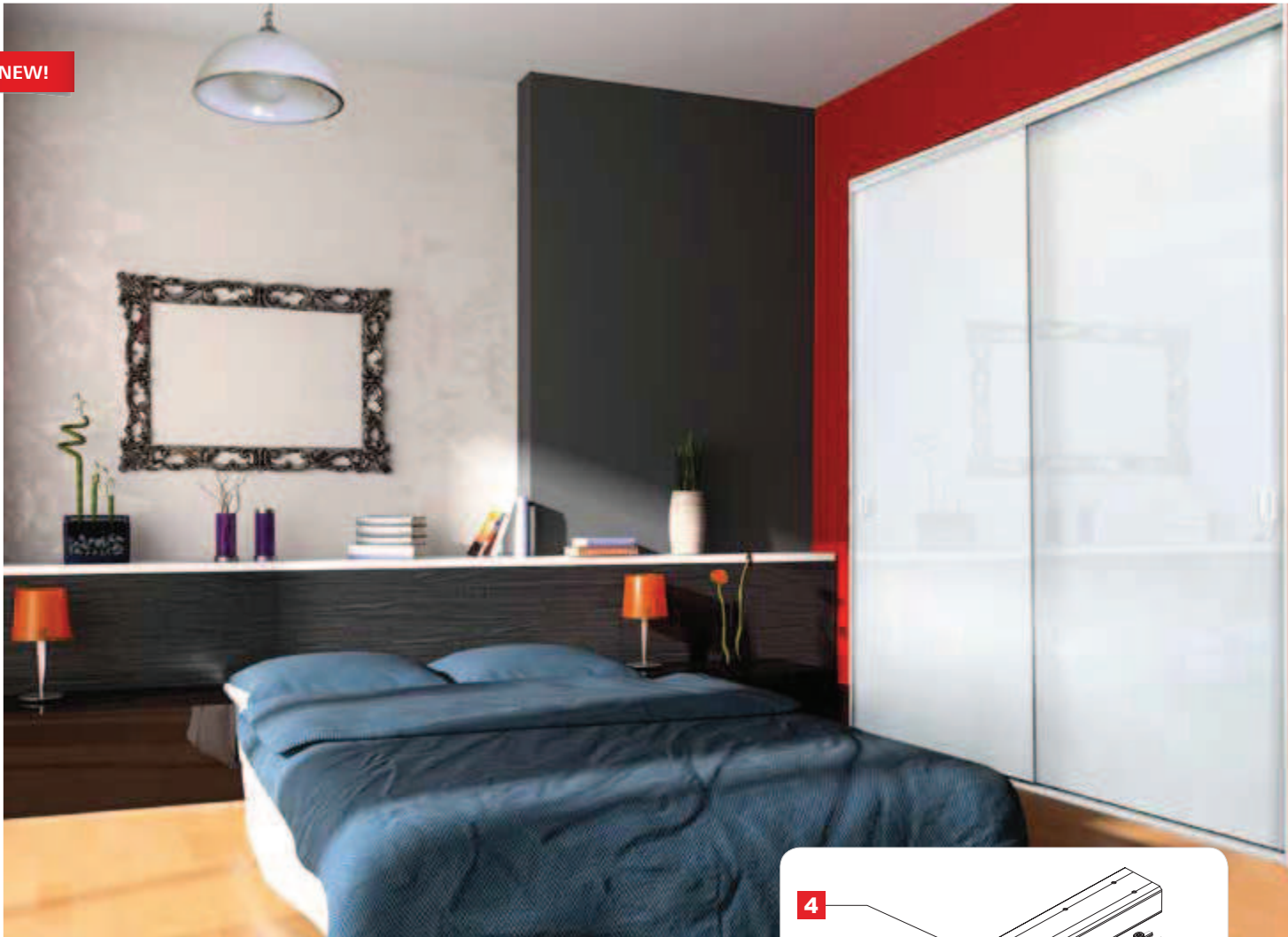

## CHARACTERISTICS

▶ Application	Sliding doors
▶ Track	Twin
▶ Carriage system	Bottom
▶ Top guide	Ball bearing carriage
▶ Bottom guide	Ball bearing carriage (load bearing)
▶ Construction	Frame
▶ Filling	4 mm safety glass or mirror
▶ Max. door load	50 kg
▶ Max. handle length	3000 mm
▶ Max. track length	6000 mm
▶ Textile door stops	Yes
▶ Anti-dust brushes	Yes
▶ Sales programme	Components can be purchased separately
▶ Decorative profile programme	n/a

## USAGE

- ▶ Built-in furniture, walk-in wardrobes, wardrobes, attics



## Basic system components

Handle **PAX**

1a

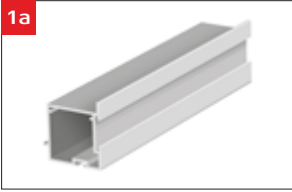

CODE	COLOUR	LENGTH (mm)	COLLECTIVE PACKAGING	PRICED PER	NET PRICE
04094	SILVER	2700	20	item	
04098	RAL WHITE GLOSS	2700	20	item	
04102	SILVER	3000	20	item	
04101	RAL WHITE GLOSS	3000	20	item	

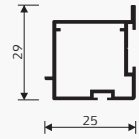
Handle **PAX XL**

1b

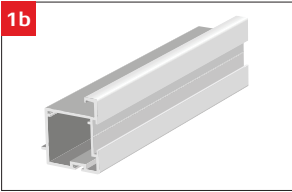

CODE	COLOUR	LENGTH (mm)	COLLECTIVE PACKAGING	PRICED PER	NET PRICE
04414	SILVER	2700	20	item	
04416	RAL WHITE GLOSS	2700	20	item	
04415	SILVER	3000	20	item	
04417	RAL WHITE GLOSS	3000	20	item	

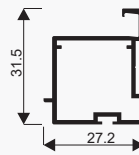
Gap filler **PAX**

**i** Set includes 4 pcs

1 +

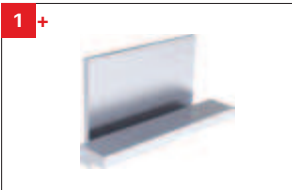

CODE	COLOUR	COLLECTIVE PACKAGING	PRICED PER	NET PRICE
20298	SILVER	100	set	
20299	RAL WHITE GLOSS	100	set	

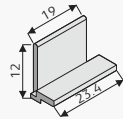
Top horizontal profile **PAX**

2a

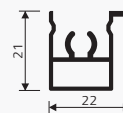

CODE	COLOUR	LENGTH (mm)	COLLECTIVE PACKAGING	PRICED PER	NET PRICE
04096	SILVER	3000	12	item	
04100	RAL WHITE GLOSS	3000	12	item	

Top horizontal profile **PAX XL**

2b

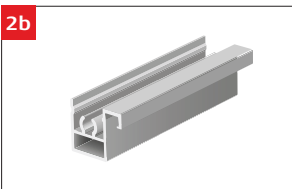

CODE	COLOUR	LENGTH (mm)	COLLECTIVE PACKAGING	PRICED PER	NET PRICE
04421	SILVER	3000	12	item	
04420	RAL WHITE GLOSS	3000	12	item	

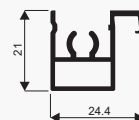

Bottom horizontal profile **PAX**

CODE	COLOUR	LENGTH (mm)	COLLECTIVE PACKAGING	PRICED PER	NET PRICE
04095	SILVER	3000	12	item	
04099	RAL WHITE GLOSS	3000	12	item	

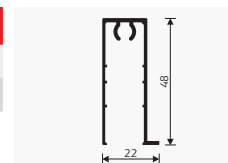
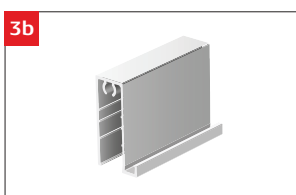
Bottom horizontal profile **PAX XL**

CODE	COLOUR	LENGTH (mm)	COLLECTIVE PACKAGING	PRICED PER	NET PRICE
04419	SILVER	3000	12	item	
04418	RAL WHITE GLOSS	3000	12	item	

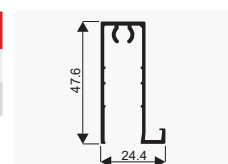
Top track **GEMINI-Decor****DECOR**

CODE	COLOUR	LENGTH (mm)	COLLECTIVE PACKAGING	PRICED PER	NET PRICE
01023	SILVER	1700	12	item	
04059	RAL WHITE GLOSS	1700	12	item	
01025	SILVER	2350	12	item	
04060	RAL WHITE GLOSS	2350	12	item	
01026	SILVER	3000	12	item	
04016	RAL WHITE GLOSS	3000	12	item	
01469	SILVER	4050	12	item	
04061	RAL WHITE GLOSS	4050	12	item	
01391	SILVER	6000	12	item	
03206	RAL WHITE GLOSS	6000	12	item	

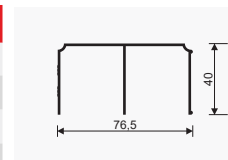
Bottom track **GEMINI-Decor****DECOR**

CODE	COLOUR	LENGTH (mm)	COLLECTIVE PACKAGING	PRICED PER	NET PRICE
00809	SILVER	1700	12	item	
00811	SILVER	2350	12	item	
00812	SILVER	3000	12	item	
01474	SILVER	4050	12	item	
02430	SILVER	6000	12	item	

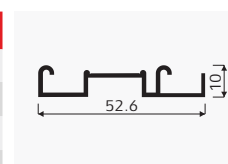



## Basic system components

Bottom track  
ELEGANT II-Decor

5b



## DECOR

CODE	COLOUR	LENGTH (mm)	COLLECTIVE PACKAGING	PRICED PER	NET PRICE
04279	SILVER	1700	12	item	
04290	RAL WHITE GLOSS	1700	12	item	
04280	SILVER	2350	12	item	
04291	RAL WHITE GLOSS	2350	12	item	
04281	SILVER	3000	12	item	
04292	RAL WHITE GLOSS	3000	12	item	
04282	SILVER	4050	12	item	
04293	RAL WHITE GLOSS	4050	12	item	
04284	SILVER	6000	12	item	
04295	RAL WHITE GLOSS	6000	12	item	

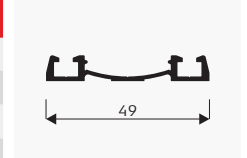
Covering strip for bottom track  
ELEGANT II-Decor

5b+



## DECOR

CODE	COLOUR	LENGTH (mm)	COLLECTIVE PACKAGING	PRICED PER	NET PRICE
04302	SILVER	1700	48	item	
04313	RAL WHITE GLOSS	1700	48	item	
04303	SILVER	2350	48	item	
04314	RAL WHITE GLOSS	2350	48	item	
04304	SILVER	3000	48	item	
04315	RAL WHITE GLOSS	3000	48	item	
04305	SILVER	4050	48	item	
04316	RAL WHITE GLOSS	4050	48	item	
04307	SILVER	6000	48	item	
04317	RAL WHITE GLOSS	6000	48	item	

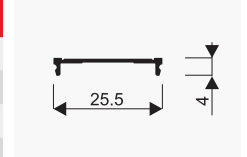
Top carriage positioner **FIX**

6a



**i** Recommended screw: Unix 3x13 (code 20096)

CODE	COLLECTIVE PACKAGING	PRICED PER	NET PRICE
20326	10	item	

Stopper for bottom carriage  
HI-TEC

6b

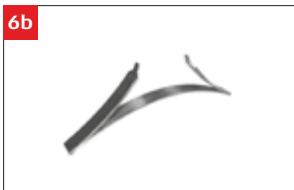

CODE	COLLECTIVE PACKAGING	PRICED PER	NET PRICE
20080	100	item	

Guiding carriage **GEMINI**

**i** Set includes two carriages, left and right, fully packaged

CODE	COLLECTIVE PACKAGING	PRICED PER	NET PRICE
10204	50	set	

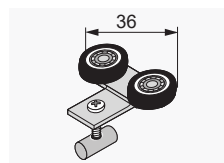

## Soft-close

**SEVROMATIC SV-25 & SV-50**

**i** Set includes 2 soft-closers (1 left and 1 right), and includes activators + screws

CODE	WEIGHT LIMIT	TYPE	COLLECTIVE PACKAGING	PRICED PER	NET PRICE
20139-SV	25 kg	LEFT + RIGHT	24	set	
20200-SV	50 kg	LEFT + RIGHT	24	set	

**Individual soft-closers**

**i** Includes one activator and screws

20137-SV	25 kg	RIGHT	20	item	
20138-SV	25 kg	LEFT	20	item	
20197-SV	50 kg	RIGHT	20	item	
20196-SV	50 kg	LEFT	20	item	

Soft-close **SEVROMATIC MINI SV-25, SV-40 & SV-60**

**i** Set includes 2 soft-closers and includes activators + screws

CODE	WEIGHT LIMIT	TYPE	COLLECTIVE PACKAGING	PRICED PER	NET PRICE
20368-SV	25 kg	UNIVERSAL	24	set	
20258-SV	40 kg	UNIVERSAL	24	set	
20339-SV	60 kg	UNIVERSAL	24	set	

**Individual soft-closers**

**i** Additionally, you must order a set of activators code 20265-SV. Soft-close MINI fits left and right sides

20359-SV	25 kg	UNIVERSAL	100	item	
20260-SV	40 kg	UNIVERSAL	100	item	
20336-SV	60 kg	UNIVERSAL	100	item	

Soft-close **SEVROMATIC TOP SV-60 & SV-80**

**i** Set includes 2 soft-closers and includes activators + screws. Soft-close TOP fits left and right sides

CODE	WEIGHT LIMIT	TYPE	COLLECTIVE PACKAGING	PRICED PER	NET PRICE
20259-SV	60 kg	UNIVERSAL	24	set	
20267-SV	80 kg	UNIVERSAL	24	set	

Soft-Close **SEVROMATIC CENTRAL SV-25 i SV-40**

**i** Set includes 1 soft-close and includes activators + screws.

CODE	WEIGHT LIMIT	TYPE	COLLECTIVE PACKAGING	PRICED PER	NET PRICE
20363-SV	25 kg	CENTRAL	24	set	
20319-SV	40 kg	CENTRAL	24	set	





## Basic system components

Soft-close activator  
„10” MINI / „10” TOP

**i** Set includes 3 activators of different heights to choose from and a set of screws

CODE	COLOUR	COLLECTIVE PACKAGING	PRICED PER	NET PRICE
20265-SV	GREY	24	set	

Bottom carriage  
WD 10C HI-TEC

**i** Set includes two carriages. Fully packaged

CODE	COLLECTIVE PACKAGING	PRICED PER	NET PRICE
10200	50	set	

Bottom carriage  
WD 10V HI-TEC

**i** Set includes two carriages and stopper HI-TEC. Fully packaged

CODE	COLLECTIVE PACKAGING	PRICED PER	NET PRICE
10201	50	set	

Strengthening profile



CODE	COLOUR	LENGTH (mm)	COLLECTIVE PACKAGING	PRICED PER	NET PRICE
04318	SILVER	3000	12	item	

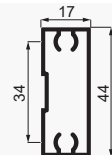

Spacer profile 04

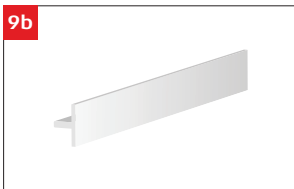

CODE	COLOUR	LENGTH (mm)	COLLECTIVE PACKAGING	PRICED PER	NET PRICE
04319	SILVER	3000	120	item	
04320	RAL WHITE GLOSS	3000	120	item	



Self-adhesive handle  
110x35x6 mm



CODE	COLOUR	COLLECTIVE PACKAGING	PRICED PER	NET PRICE
20328	SILVER	50	item	
20329	RAL WHITE GLOSS	50	item	
20327	TRANSPARENT	20	item	

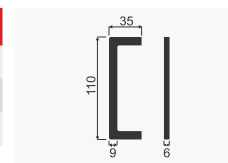

Double sided foam tape



CODE	LENGTH (mm)	HEIGHT (mm)	COLLECTIVE PACKAGING	NET PRICE
20343	5000	19	100	

### TEXTILE DOOR STOP

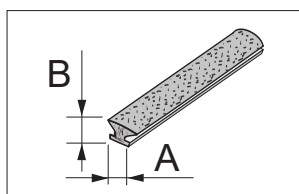

**i** Our full offer can be found in the “Profiles and furniture accessories” section

CODE	NAME	A (mm)	B (mm)	INSTALLATION	ROLL LENGTH	COLLECTIVE PACKAGING	PRICED PER
20024-SV	ANTI-DUST BRUSH	4,8	13	INSERTED	200 r.m.	4 rolls	running M
20226-SV	ANTI-DUST BRUSH	4,8	13	INSERTED	50 r.m.	10 rolls	roll
20094-SV	TEXTILE DOOR STOP	14	4	INSERTED	200 r.m.	4 rolls	running M
20224-SV	TEXTILE DOOR STOP	14	4	INSERTED	50 r.m.	10 rolls	roll
20288-SV	TEXTILE DOOR STOP WHITE	14	4	INSERTED	50 r.m.	10 rolls	roll

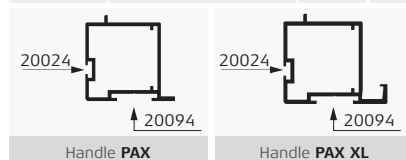

Screws **SMART, UNIX**  
& **SELF-TAPPING**

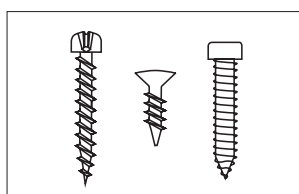

CODE	NAME	DIMENSIONS (mm)	PRICED PER	COLLECTIVE PACKAGING	NET PRICE
20041	SCREW SMART	2.5x18	100 pcs	100 packs	
20092	SCREW SMART	2.5x25	100 pcs	100 packs	
20107	COUNTERSUNK SCREW UNIX	3x13	100 pcs	20 packs	
20001	SELF-TAPPING SCREW	6.3x32	1 pc.	2000 pcs	

Gasket for frame profiles  
**TYPE II S01/S02/S04**

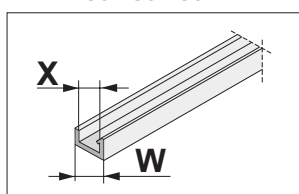

CODE	W (mm)	X (mm)	ROLL LENGTH	PRICED PER	NET PRICE
20167	6	4	300 r.m.	running M	



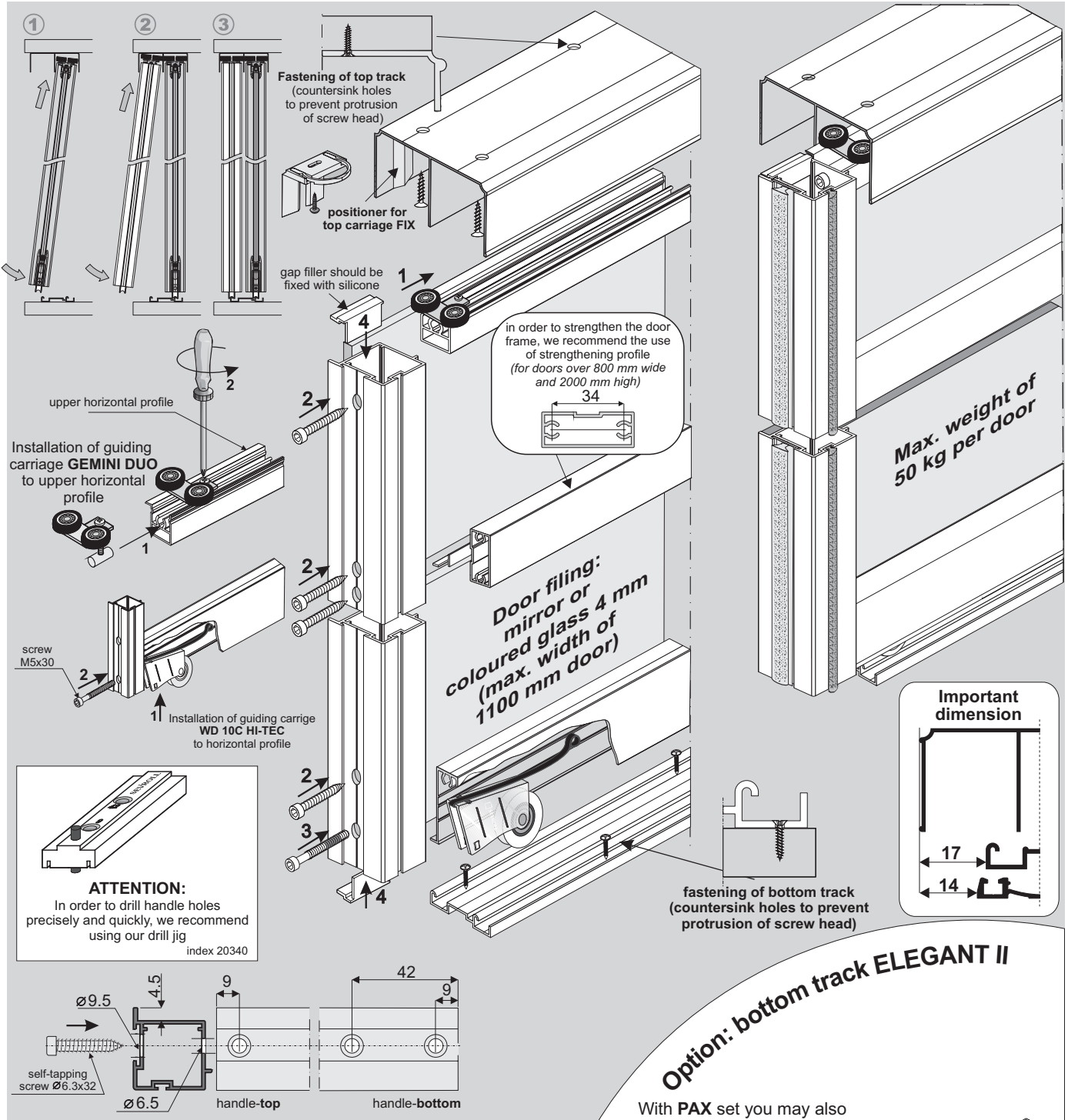

**Option: bottom track ELEGANT II**

With PAX set you may also use bottom track **Elegant II** with covering strip along with bottom carriage **WD 10V HI-TEC**. Fitting measurements are not affected.

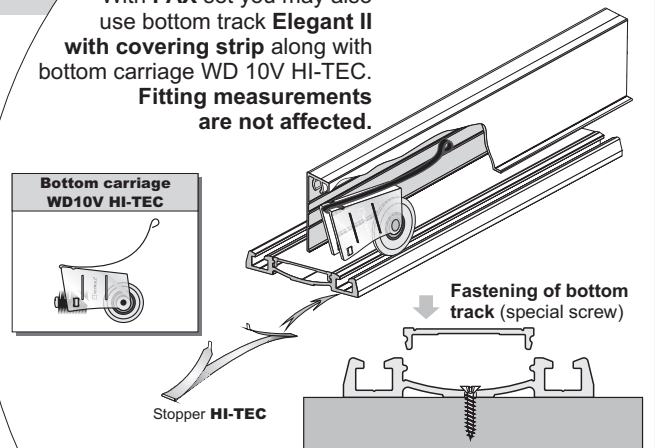

**COMPONENTS**

<p><b>Handle Pax</b></p> <p>Anti-dust brush (inserted) 4.8 x 13 mm</p> <p>Textile door stop (inserted) 14 x 4 mm</p> <p>Length: 2.7 m</p>	<p><b>Top track Gemini Decor</b></p> <p>76 mm</p> <p>Length: 1.7 m, 2.35 m, 3.0 m, 4.05 m, 6.0 m</p>	<p><b>Bottom track Gemini Decor</b></p> <p>53 mm</p> <p>Length: 1.7 m, 2.35 m, 3.0 m, 4.05 m, 6.0 m</p>	<p><b>Gap filler Pax</b></p> <p>4x</p>
<p><b>Guiding carriage Gemini WPGm-DUO</b></p>	<p><b>Lower horizontal profile Pax (A)</b></p> <p><b>Top horizontal profile Pax (B)</b></p> <p>Length A, B: 3.0 m</p>	<p><b>Bottom carriage WD10C HI-TEC</b></p>	<p><b>Strengthening profile (A) Spacer profile 04 (B)</b></p> <p>Length: 3.0 m</p>

You must remember to purchase self-tapping screws to construct each door (4 screws per door).



Dimensions of opening

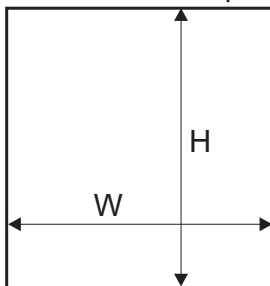

door filling:  
- mirror # 4 mm,  
coloured glass

Handle length = door height

Door height	- h	$h = H - 40 \text{ mm}$
Door wing height with soft-close fitted	Mini SV25/40/60, SV-25/50	$h = H - 40 \text{ mm}$
	Top SV60/80, Central SV25/40	$h = H - 44 \text{ mm}$
Mirror height	- hm	$hm = h - 4 \text{ mm}$
Door width	- w	$w = (W - 3 \text{ mm} + Z) : N$
Mirror width	- wm	$wm = w - 4 \text{ mm}$
Lower horizontal profile length - L Upper horizontal profile length - U		$L = U = w - 50 \text{ mm}$
Spacer profile 04 length		$S + 46 \text{ mm}$

Number of doors - N	2	3	4	5
Total overlap - Z	25 mm	50 mm	75 mm	100 mm

Visual design - 4 wings	
	$w = (W - 3 + 75) : 4$
	$w = (W : 2 + 22) : 2$

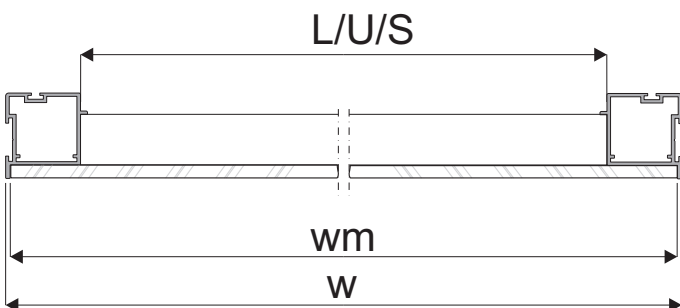

It is recommended to use soft-close with system PAX

Installation method for fitting mirror or coloured glass 4 mm

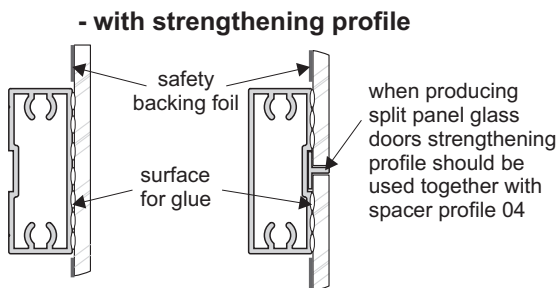
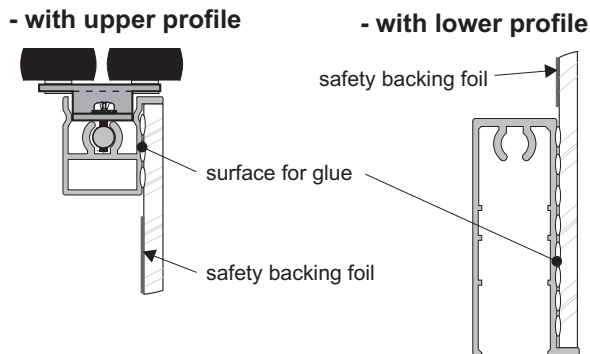
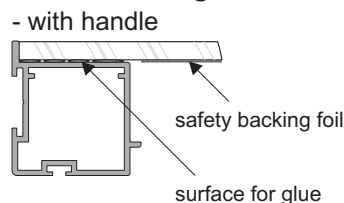

it is recommended that mirror / coloured glass is glued to aluminium profiles with specialist glass adhesive

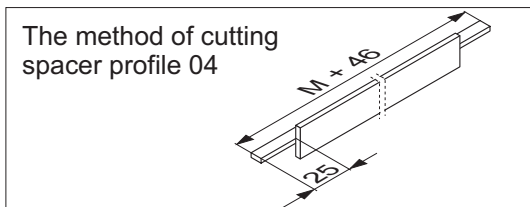

**ATTENTION!**  
Rear mirror /coloured glass surface must be secured with safety backing foil (excluding glass surface glued with mirror adhesive). The edges of glass must be polished.

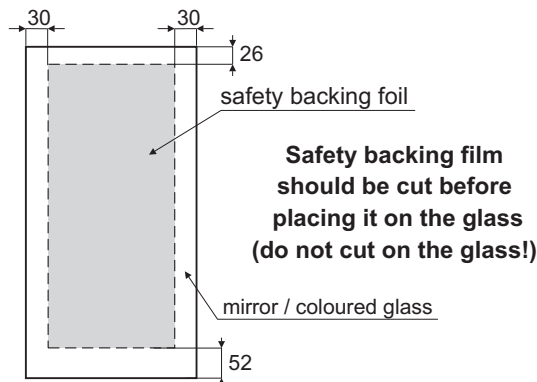

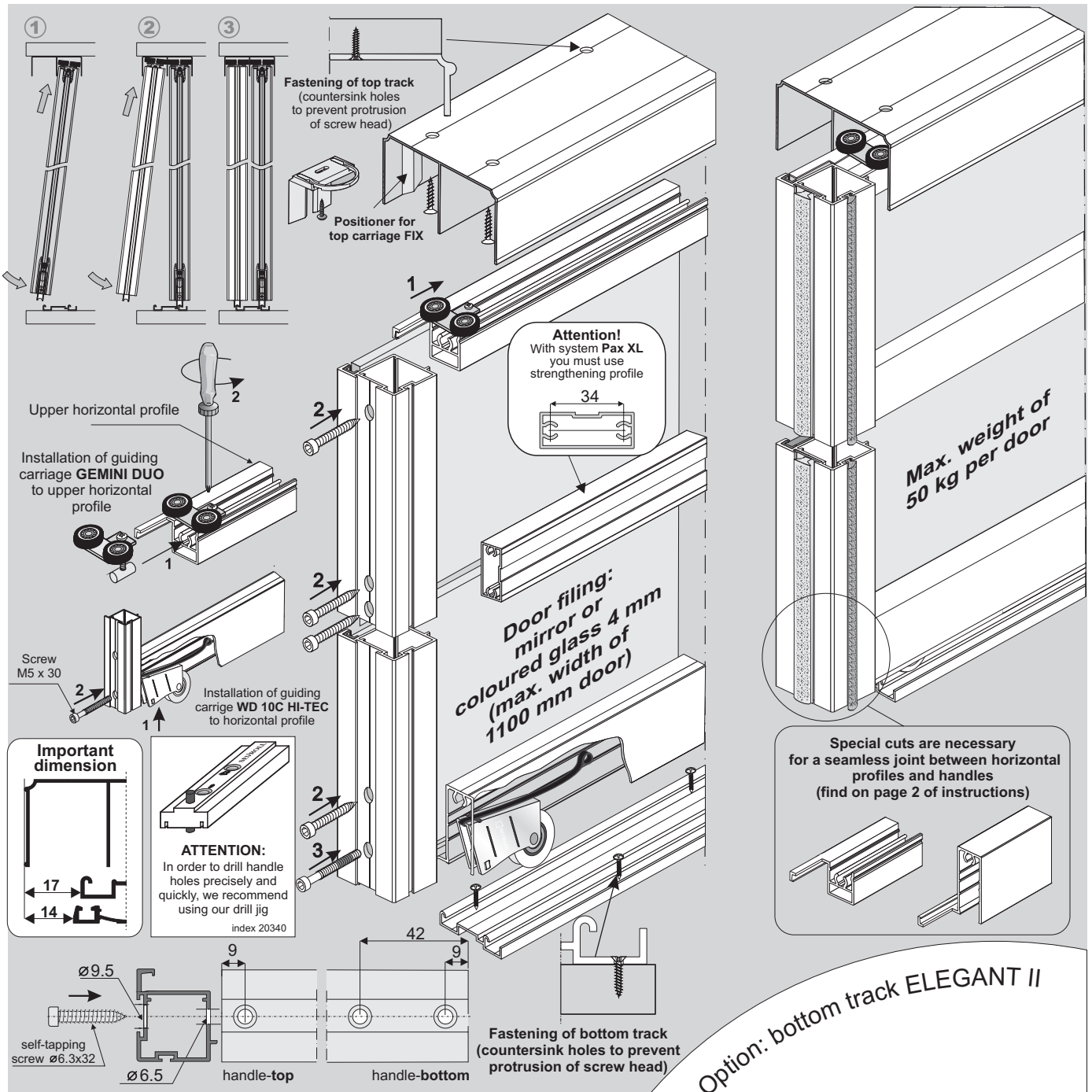

**COMPONENTS**

<p><b>Handle Pax XL</b></p> <p>Anti-dust brush (inserted) 4.8 x 13 mm</p> <p>Textile door stop (inserted) 14 x 4 mm</p> <p>Length: 2.7 m</p>	<p><b>Top track Gemini-Decor</b></p> <p>76 mm</p> <p>Length: 1.7 m, 2.35 m, 3.0 m, 4.05 m, 6.0 m</p>	<p><b>Bottom track Gemini-Decor</b></p> <p>53 mm</p> <p>Length: 1.7 m, 2.35 m, 3.0 m, 4.05 m, 6.0 m</p>	<p><b>Gasket for frame type II</b></p> <p>(20167)</p>
<p><b>Guiding carriage Gemini WPGm-DUO</b></p>	<p><b>Lower horizontal profile Pax XL (A)</b></p> <p><b>Upper horizontal profile Pax XL (B)</b></p> <p>Length: A, B: 3.0 m</p>	<p><b>Bottom carriage WD10C HI-TEC</b></p>	<p><b>Strengthening profile</b></p> <p>Length: 3 m</p>

You must remember to purchase self-tapping screws to construct each door (4 screws per door).

With Pax XL set you may also use bottom track **Elegant II** with covering strip along with bottom carriage WD10V HI-TEC. Fitting measurements are not affected.

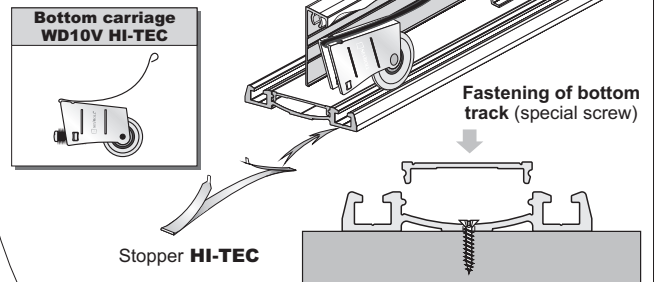



**door filling:**  
- mirror # 4 mm,  
coloured glass

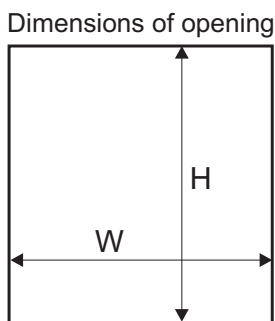

Handle length = door height

Door height	- h	$h = H - 40 \text{ mm}$
Door wing height with soft-close fitted	Mini SV25/40/60, SV-25/50	$h = H - 40 \text{ mm}$
	Top SV60/80, Central SV25/40	$h = H - 44 \text{ mm}$
Mirror height	- hm	$hm = h - 6 \text{ mm}$
Door width	- w	$w = (W - 3 \text{ mm} + Z) : N$
Mirror width	- wm	$wm = w - 6 \text{ mm}$
Lower horizontal profile length	- L	$L = U = w - 12 \text{ mm}$
Upper horizontal profile length	- U	
Strengthening profile length	- S	$S = w - 50 \text{ mm}$

Number of doors	- N	2	3	4	5
Total overlap	- Z	25 mm	50 mm	75 mm	100 mm

Visual design - 4 wings	
	$w = (W - 3 + 75) : 4$
	$w = (W : 2 + 22) : 2$

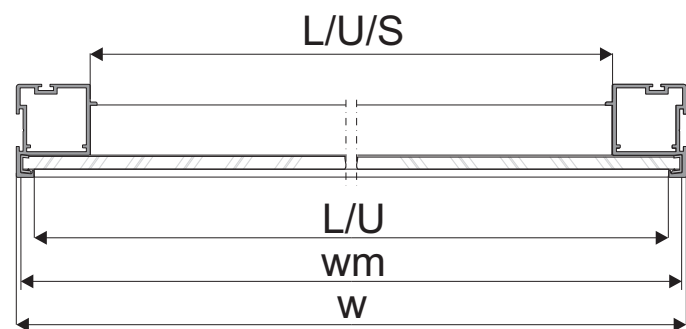

It is recommended to use soft-close with system PAX XL!

**ATTENTION!**  
Step 1: insert gasket to profile  
Step 2: fit glass to inserted gasket

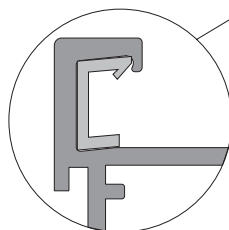

**Installation method for fitting mirror or coloured glass 4 mm**

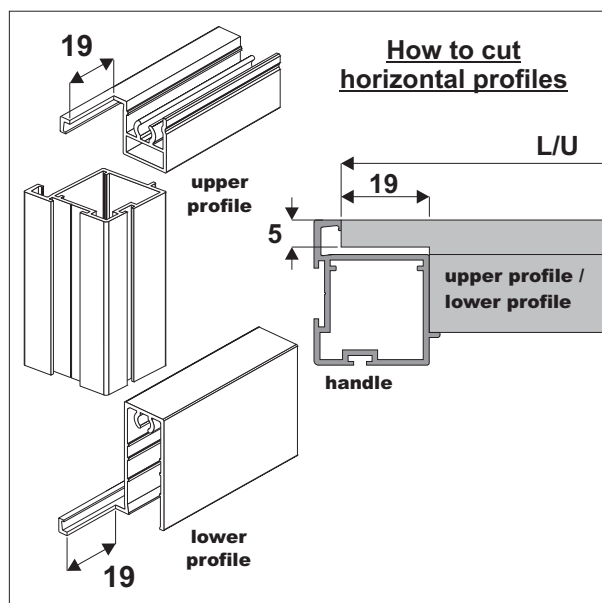
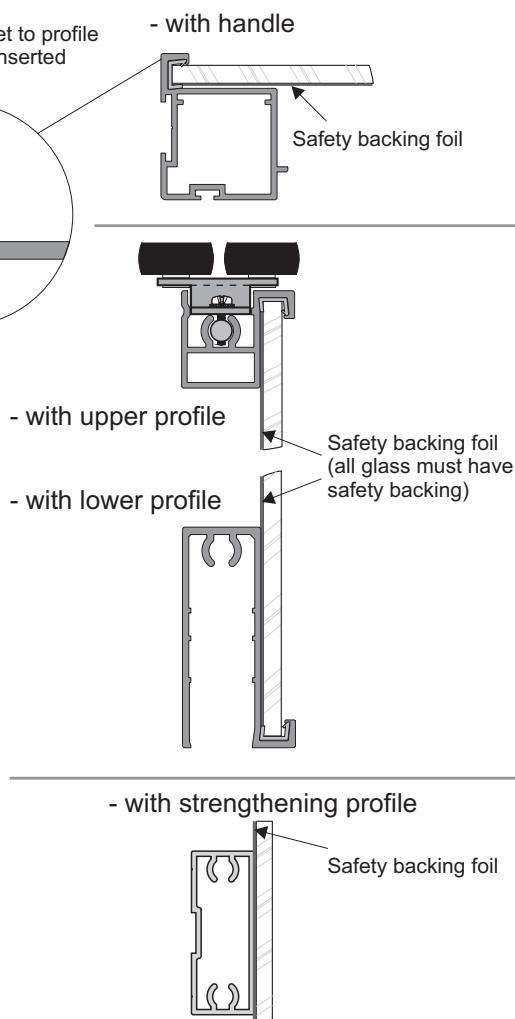

**ATTENTION!**  
Rear mirror /coloured glass surface must be secured with safety backing foil.  
The edges of glass must be polished.